

GNSS Receiver Measurement Application

Smart Construction Rover Manual

Application Ver. 000400 or later

Feb 01, 2023

For the settings of the [SC Rover] receiver body,
refer to the "RTFSetting" manual.

株式会社アカサカテック
AKT

Contents

Chapter 1 Equipment Used _____	5
1-1. [SC Rover] specifications	6
1-2. [SC Rover] internal switches	7
1-3. [SC Rover] start and stop	8
1-4. [SC Rover] and [SC Rover App] equipment configurations	9
1-5. Wi-Fi access point connection between [SC Rover] and the Android terminal	10
1-6. [SC Rover] - [SC Rover App] connection Specifications	11
1-7. Precautions for using [SC Rover] also as a base station	12
Chapter 2 SC Rover App Version Upgrade, Uninstallation, and Installation _____	13
2-1. Uninstalling SC Rover App	14
2-2. Installing SC Rover App.....	21
Chapter 3 Pre-Setting for Measurement _____	29
3-1. Logging in to SC Rover App	30
3-1-1. Logging in to SC Rover App	31
3-1-2. Logging in to LANDLOG	33

Contents

3-2. Creating a project	36
3-2-1. Creating a project	37
3-2-2. Linking to a LANDLOG work	40
3-2-3. LANDLOG work search	42
3-3. GNSS settings	43
3-4. Ntrip settings	47
3-4-1. Ntrip settings	48
3-5. Coordinate settings	50
3-5-1. Measurement with a projection	51
3-5-2. Performing localization	52
3-5-2-1. Registering the reference point coordinates	53
3-5-2-2. Reflecting the localization results measured by a competitor's system	60
3-5-2-3. Exporting the localization file	85
3-6. Display settings	89
3-6-1. Importing a DXF file	90
3-6-2. Importing a LandXML file	93
3-6-3. Setting the language, units, decimal point notation, and separator	96

Contents

Chapter 4 Pre-Measurement Checks _____	97
4-1. Starting the tablet (Motog7) and [SC Rover]	98
4-2. Starting SC Rover App	101
4-3. Inputting the antenna height	103
4-4. Selecting the layer	104
Chapter 5 Localization _____	106
5-1. Localization actual measurement	107
5-2. Localization guidance function	112
5-3. Remeasuring the measured reference point	116
5-4. Reference point residual calculation	118
5-5. Registering the control points	120
5-6. Switching the use mode of localization measurement points	122
Chapter 6 GC3 File Download _____	125
6-1. GC3 file download	126

Contents

Chapter 7 Measurement Screen _____	128
7-1. Measurement screen	129
Chapter 8 Importing and Displaying Design Data (LandXML) Files _____	135
8-1. Importing and displaying design data (LandXML) files	136
Chapter 9 Actual Measurement _____	146
9-1. General single-point measurement	147
9-2. Reversed placing single-point measurement	153
9-3. Survey line single-point measurement	159
Chapter 10 Measurement Point Position Checks _____	164
10-1. Checking the measured points	165
10-2. Exporting the measured points	167
Chapter 11 Quick3D (GCP measurement) _____	173
11-1. Measurement by reading the QR code	174
11-2. Measuring the ground control points (GCPs) manually	179

Chapter 1

Equipment Used

1-1. [SC Rover] specifications



Two-frequency multi-GNSS receiver [SC Rover]

Receiving channels
Received signal

: 184
: GPS L1C/A,L2C
GLOANSS L1OF,L2OF
GALILEO E1-B/C,E5b
BeiDou B1I,B2I
QZSS L1C/A,L2C

* The QZSS is not used in RTK analysis.

Accuracy (RTK)

: Horizontal 0.01 m + 1 ppm (× baseline distance) CEP
Vertical 0.01 m + 1 ppm (× baseline distance) CEP

* Depends on the usage environment. Accuracy is not guaranteed.

Dustproof and waterproof

: IP65 (When the connector is covered with a dedicated cap)
*** Note that outdoor installation of a naked receiver is not supported.**

Operating temperature range

: -20°C to 60°C

* It may stop working if the temperature in the receiver exceeds the range due to exposure to direct sunlight at the installation location.

External power range

: DC9 to 36 V

Use of batteries (approx. 4 h operation time with 4 AA batteries for general Ni-MH batteries)



Multi-GNSS antenna [AR270]

Four-frequency GNSS antenna

Compatible with L1, L2, L5, and L6

IP67: Installable outdoors at all times.

* When installing it outdoors at all times, cover the antenna cable connector with self-adhesive tape.

1-2. [SC Rover] internal switches (back of receiver: inside battery case)

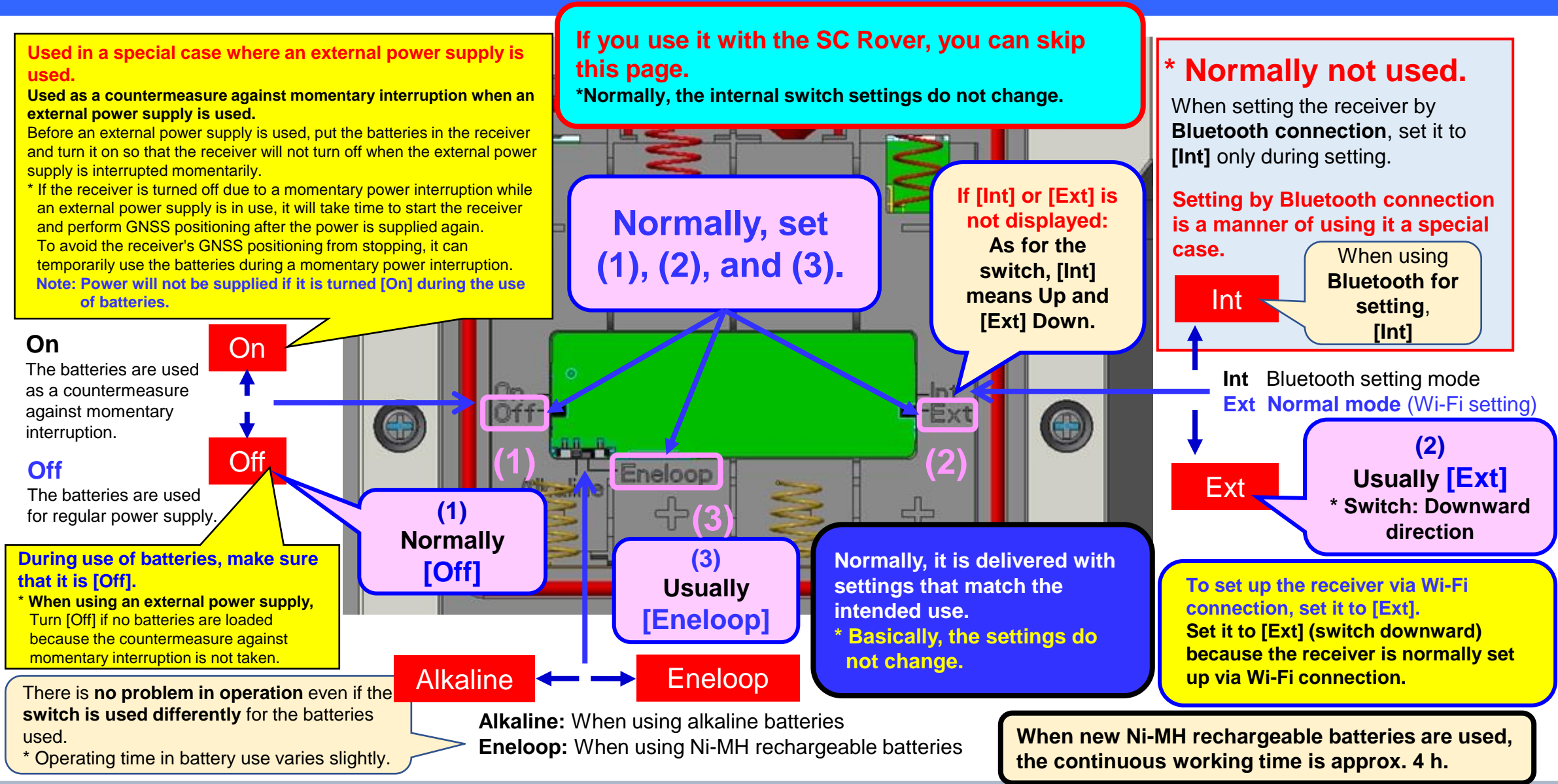

1-3. [SC Rover] start and stop (receiver lamp)

[Power On/Off] button

* Use it to turn on/off the power when the batteries are used.

Hold it down for approx. 2 s.

When using an external power supply, you do not need to press any button.

When the batteries are used, if the BATT lamp turns **[red]**, the remaining battery power is low.

* Replace the batteries.

▶ Start (power on)

■ When using the batteries

The BATT LED lights up in **[green]** by pressing the [Power On/Off] button.

* It takes some time (approx. 50 s) to complete the startup.

■ When using an external power supply

When **power is supplied** from an external power supply, the BATT LED lights up in **[red]** and it **automatically starts up**.

* It takes some time (approx. 50 s) to complete the startup.

After all the [GNSS], [Wi-Fi], and [BT] LEDs **light up**, the receiver starts up.

When starting in mobile station mode,

GNSS: On; Wi-Fi/BT: Flashing → **Normal operation.**

* If GNSS is flashing, the satellite is not yet acquired.

Supplement: When Komatsu Ntrip Caster is in use in base station mode, the **Wi-Fi lamp lights up** if it has connected to the server successfully and is sending correction data to it.
Refer to the "RTFSetting" manual.

▶ Stop (power off)

■ When using the batteries

It stops by pressing the [Power On/Off] button when the BATT LED lights up in **[green]**.

* It takes some time to stop.

■ When using an external power supply

It stops by turning off the **external power supply** when the BATT LED lights up in **[red]**.

You do not need to press any button.

* It takes some time to stop.

When **all the LEDs go out**, the start process stops.

Reset of the GNSS receiver

No reset operation of the GNSS receiver is required.

* It is reset at the start time. (The last settings are imported after reset.)

Firmware update (automatic update)

If the power is turned ON and all the [GNSS], [Wi-Fi], and [BT] LEDs remain lit (normally approx. 1 min) before the power automatically turns OFF, the [SC Rover] firmware may have been automatically updated.

- When it is using batteries, press the power button again to turn it on.
- For a model compliant with the operation with an external power supply, the restart takes place automatically and the power is turned on.

1-4. [SC Rover] and [SC Rover App] equipment configurations

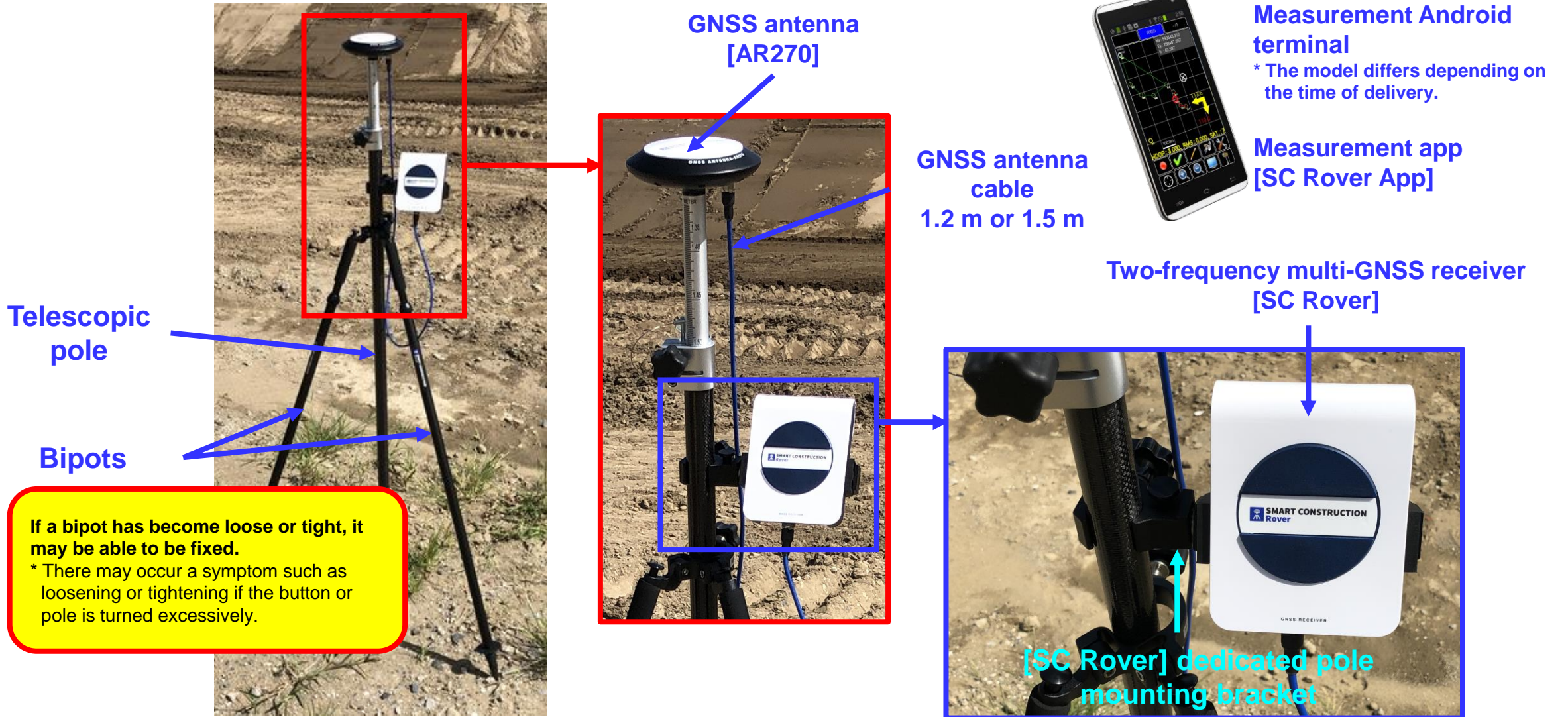

1-5. Wi-Fi access point connection between [SC Rover] and the Android terminal



For the **Wi-Fi connection** between [SC Rover] and the [Android terminal], the former is **the client**, and the latter is **the access point**.

- For [SC Rover], the SSID and password are set before delivery.
SSID: RTF500-XXXXXXXX (X...: serial number on the cover of the back side)
Password: rtf500akt (fixed)

Unchangeable

- **Setting up a Wi-Fi access point (tethering) for the Android terminal**

The terminal can be connected the [SC Rover] to use by setting the **access point name** to the **[RTF500-serial number]** and the **password** to **[rtf500akt]**.

For details, refer to the "RTFSetting" manual.

If [SC Rover] and the Android terminal are delivered as a set, the paired settings are completed for these before delivery.
If [SC Rover] and the Android terminal are delivered separately, you may need to set an access point on your Android terminal.

1-6. [SC Rover] - [SC Rover App] connection specifications (VRS/Ntrip specifications)

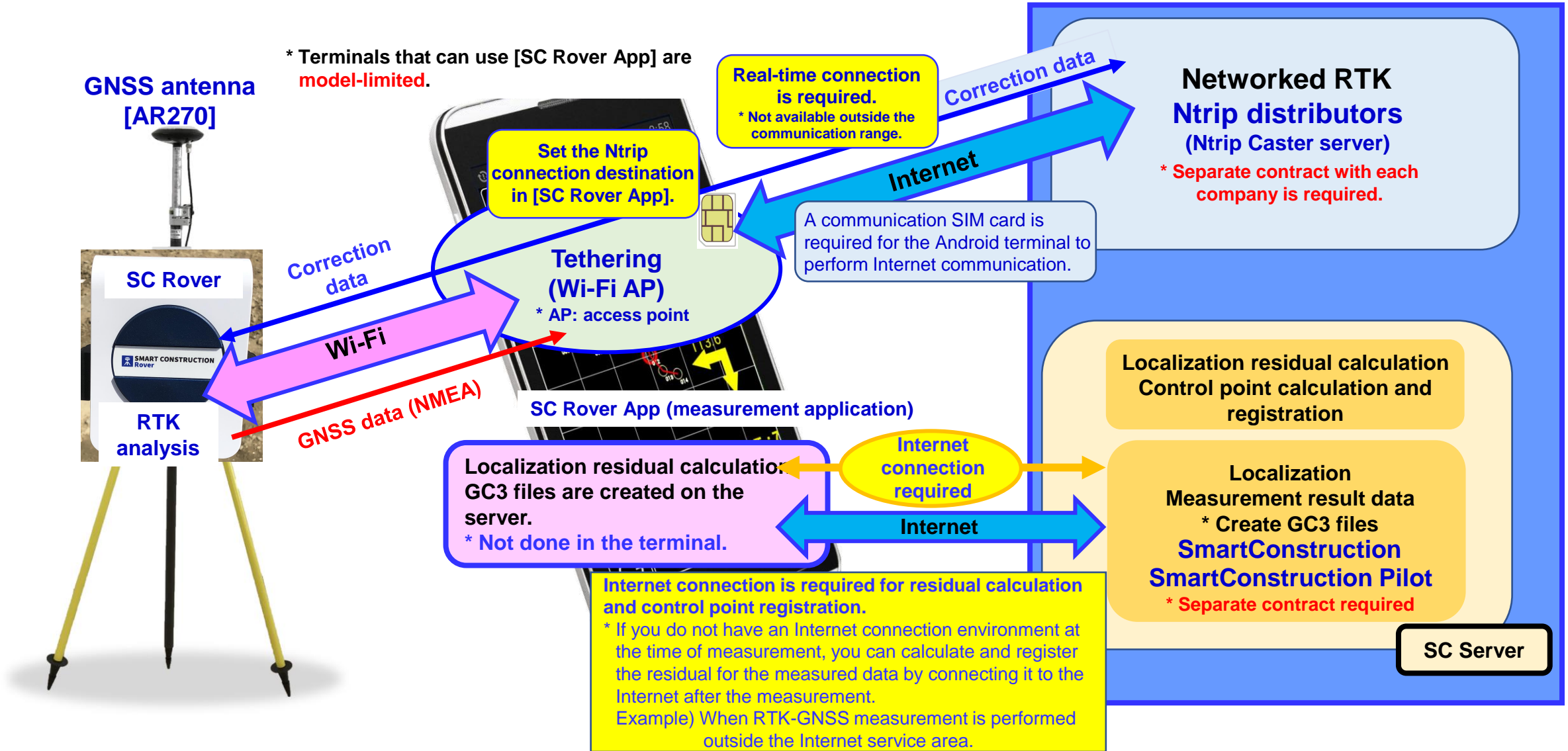

1-7. Precautions for using [SC Rover] also as a base station

FAQ

Although [SC Rover] and [SC Rover App] seem to be connected, the number of GNSS satellites is [0] and no satellites are acquired.

The cause may be a defective antenna cable, a defective GNSS antenna, or a defective GNSS receiver, but [SC Rover] might have been set as the base station.

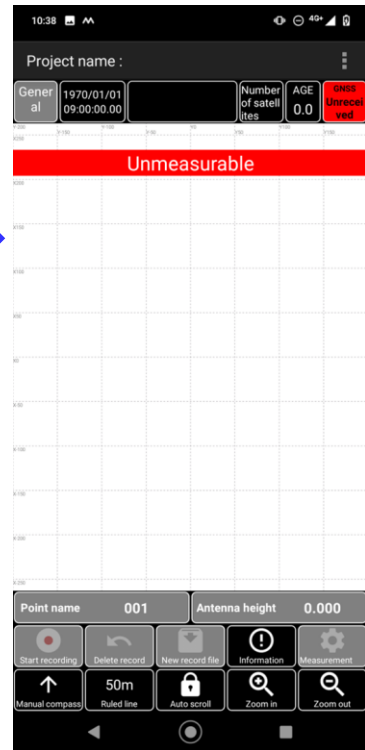

CHECK

[SC Rover] has been used in the base station mode.

Check that the [SC Rover]'s [Receiver Mode] is [Rover] in the [RTFSetting] app.

→ If it is [Base Station], change it to [Rover] and check that [RTCM In Port] is [TCP].

* The reason why the number of satellites is indicated as [0] if [Receiver Mode] is [Base Station]

→ Although it has succeeded to connect to [SC Rover], the NMEA data, including position data and the number of satellites, that should be exported in Rover mode and is required for [SC Rover App], is not exported because of being in the base station mode.

Chapter 2

SC Rover App Version Upgrade, Uninstallation, and Installation

**Check the version upgrade of the app before setting and using.
Version upgrades may be made for the addition or modification of functions without prior notice.**

If you have upgraded the version, exit the application once and restart it.

*** The new version will not be reflected until restarted.**

Pay attention when uninstalling it. Review the instructions in advance. * 2-1. Uninstalling SC Rover App

2-1. Uninstalling SC Rover App

Normally, you do not need to uninstall the app.

Precautions for uninstallation

**IMPORTANT
CHECKS**

If you have to uninstall for some reason, **check the following** in advance.

Since the uninstallation deletes all the contents of the installation folder, it deletes everything such as the data from the measurement with the terminal and the files imported.

- **(1) Back up the measured data.**
- **(2) Back up the [files] folder.**

* You can skip the backup if you do not mind the loss of the measured data and imported files so far.

For backing up the measured data, see the next page.

If you need the measured data and others, back up the data before the uninstallation.

2-1. Uninstalling SC Rover App

Backing up the measured data

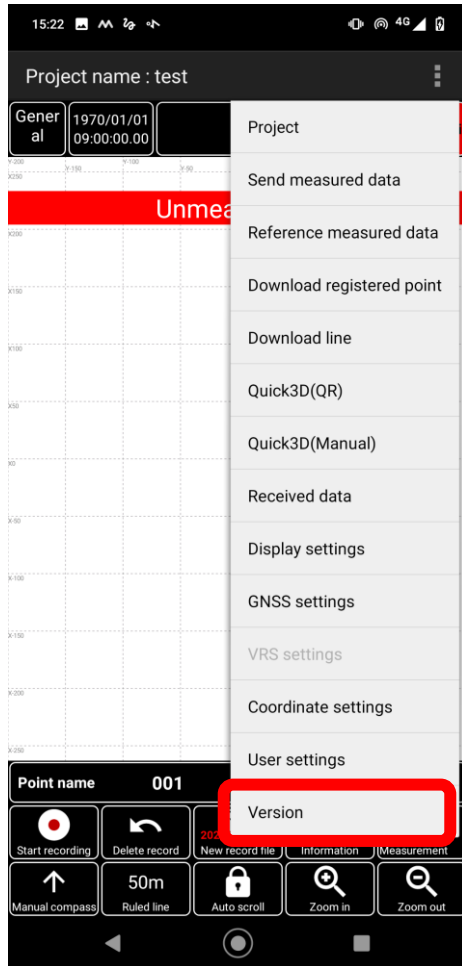

Tap the menu .
Tap **[Version]**.



The measured data is backed up.

Tap **[Save DataBase]**.

2-1. Uninstalling SC Rover App

Backing up the measured data

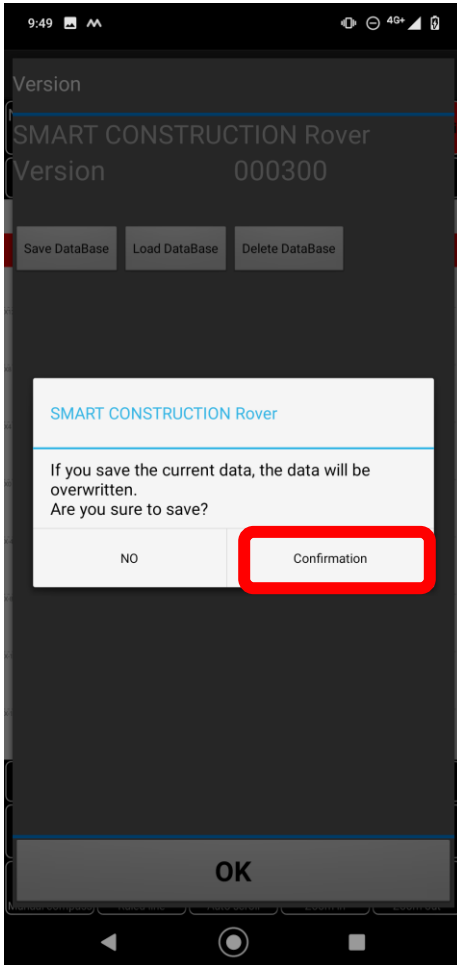

Tap [**Confirmation**].

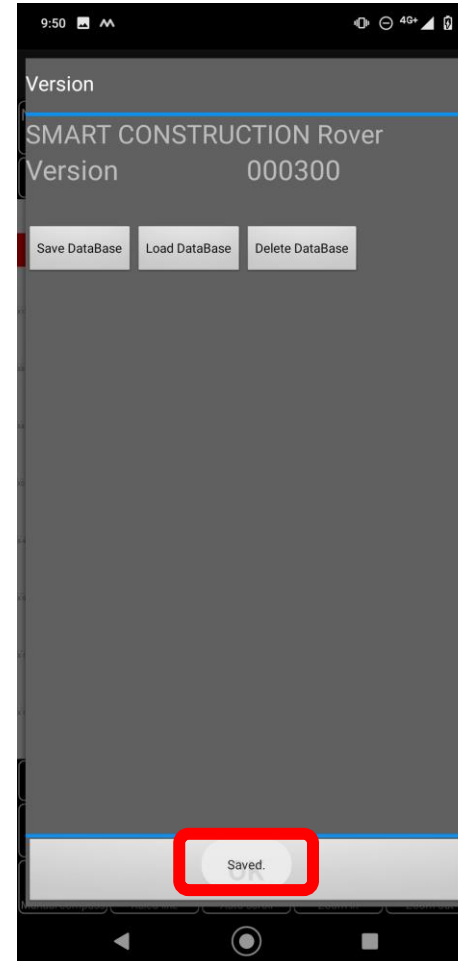

The measured data [**SC Rover App.db**] is saved in **Internal Shared Storage > Android > data > jp.akt.SC Rover App > files.**
* Ver. 000100 or later

2-1. Uninstalling SC Rover App

Backing up the measured data

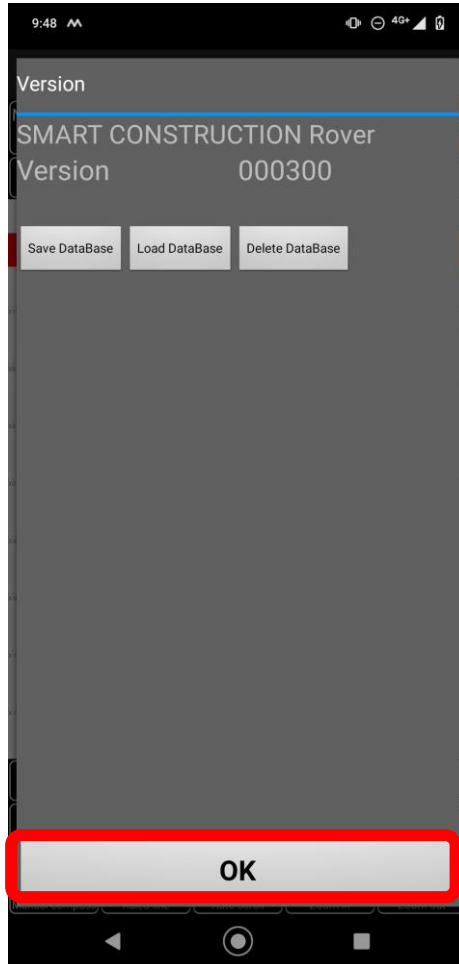

Connect the PC and measurement terminal, and back up [\[SC Rover App.db\]](#) in **Internal shared storage > Android > data > jp.akt.SC Rover App > files folder**.

For the connection between the PC computer and measurement terminal, see 3-5-2-2, "(3) Copying and pasting the CSV file to the terminal" .

Tap [OK].

2-1. Uninstalling SC Rover App

Backing up the measured data

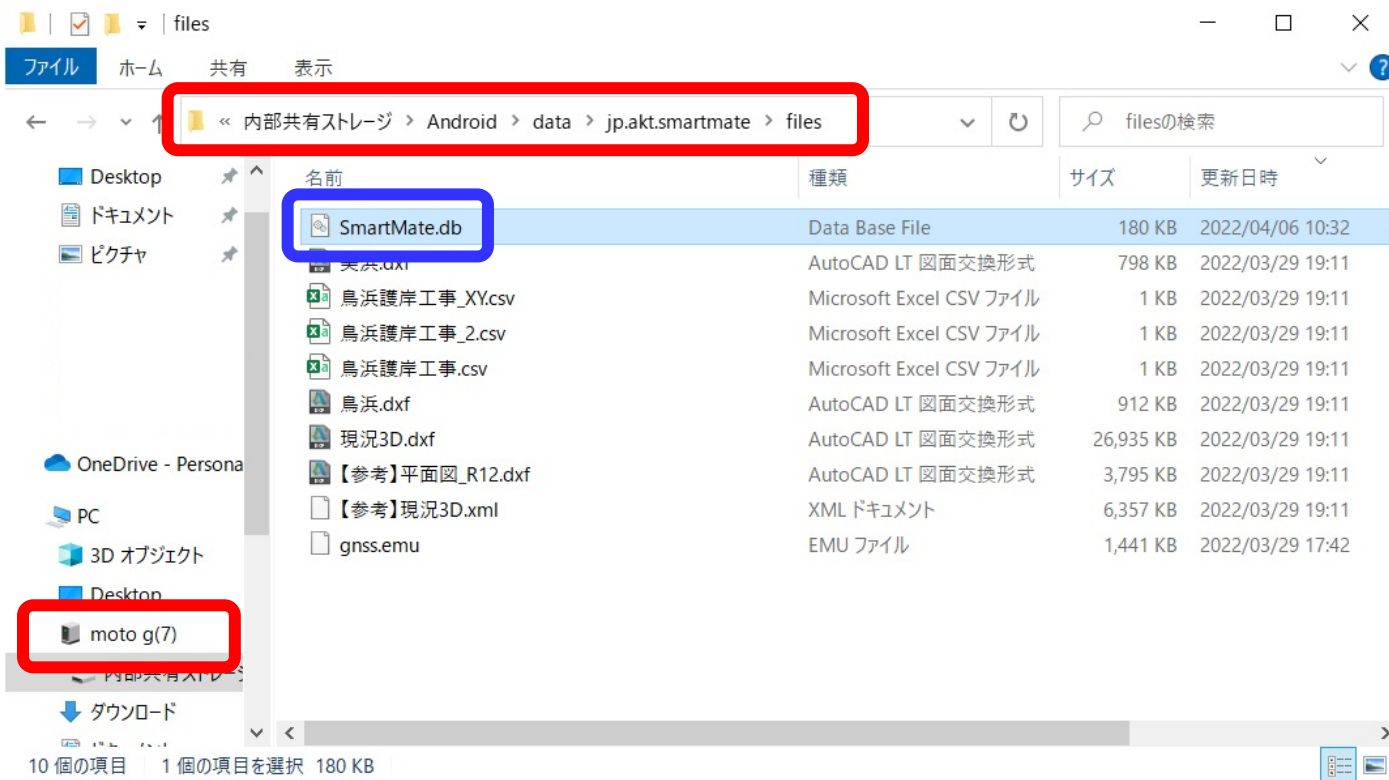

[SC Rover App.db] is the backup file of measured data.
Save any other files needed to be backed up on your PC.

2-1. Uninstalling SC Rover App



[SC Rover App] is uninstalled.

Tap the icon, and while holding it, slide it to the upper right to uninstall the app.

* The uninstallation procedure may differ depending on the terminal used.

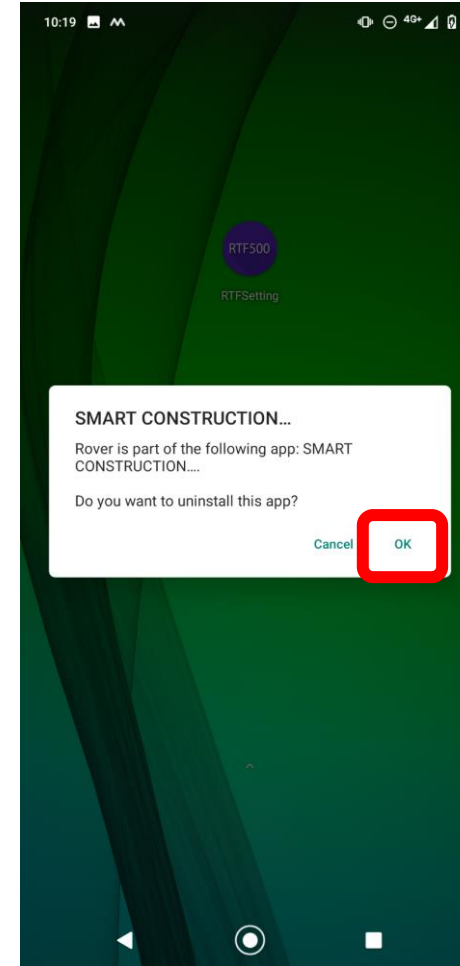

Tap **[OK]**.

2-1. Uninstalling SC Rover App

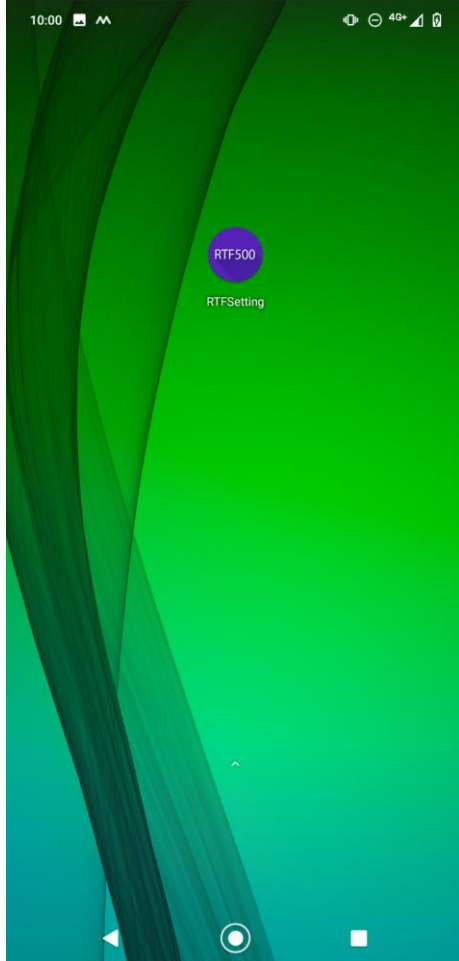

Check that it is uninstalled.

2-2. Installing SC Rover App

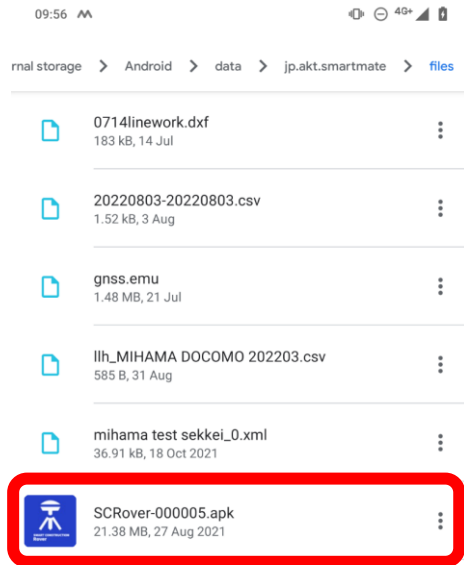

Tap the apk file saved on your terminal.

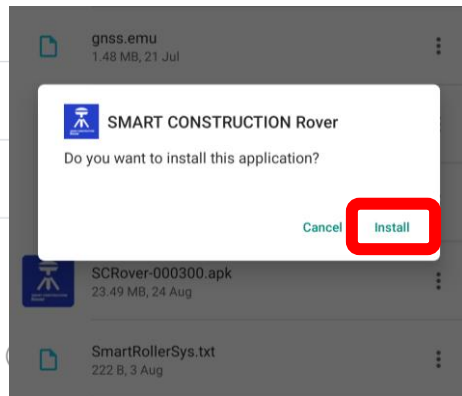

Tap [Install] on the confirmation screen that appears.

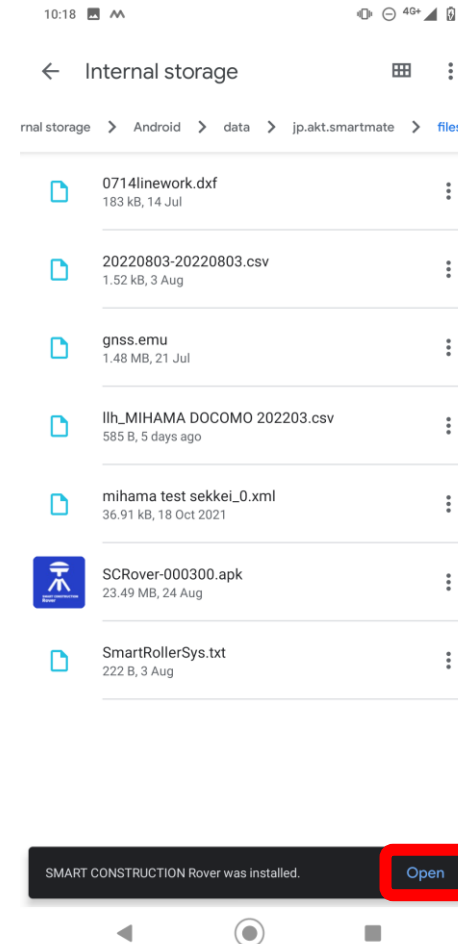

After the installation is finished, tap **[Open]**.

2-2. Installing SC Rover App

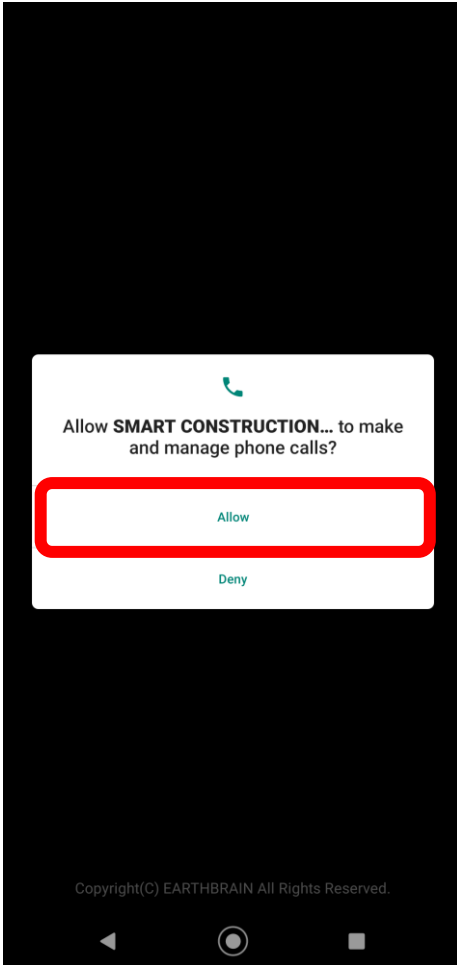

Tap **[Allow]**.

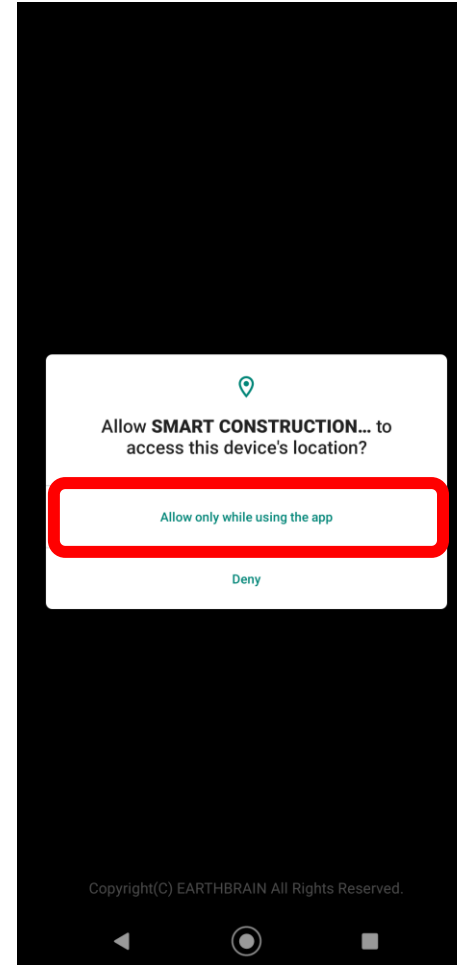

Tap **[Allow only while using the app]**.

2-2. Installing SC Rover App

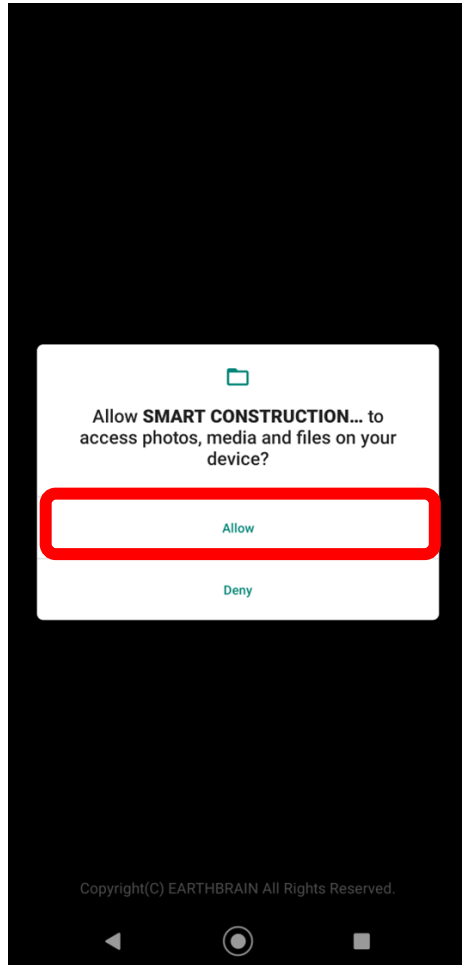

Tap **[Allow]**.

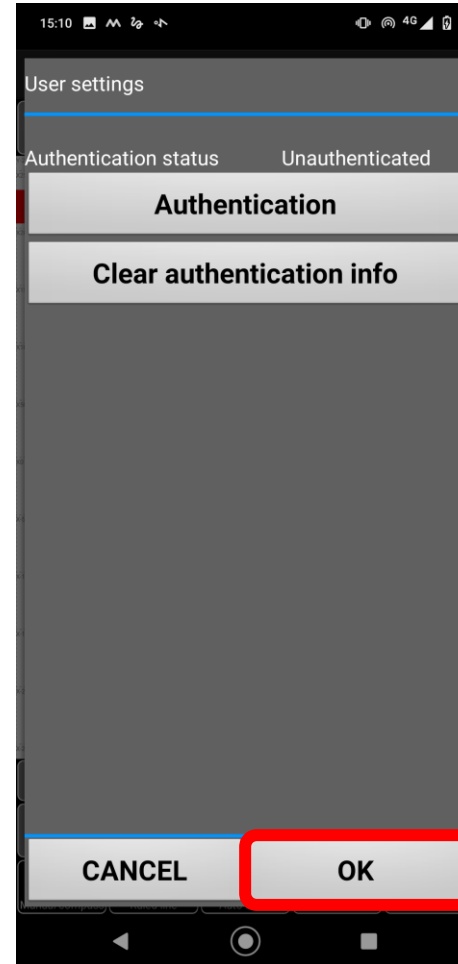

After confirmation, tap **[OK]**.

Note:
If you press **[OK]** while it is not connected to the Internet, it will not be authenticated.

2-2. Installing SC Rover App

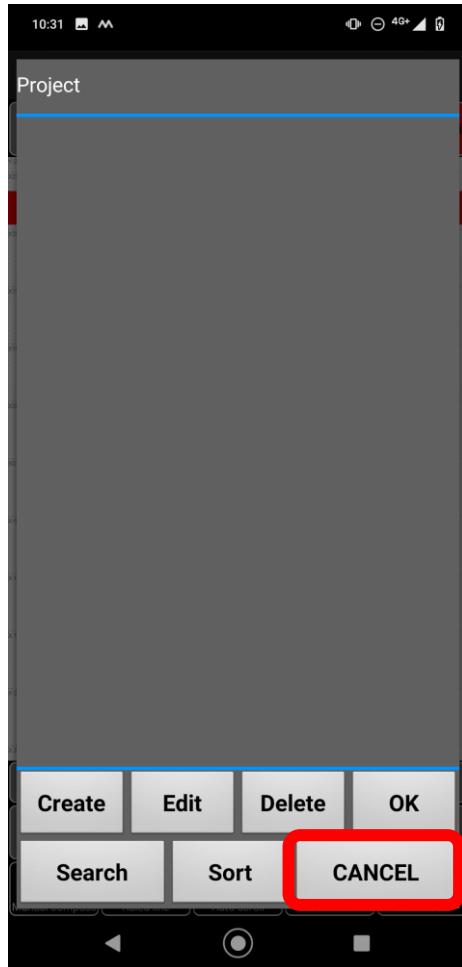

When the project creation screen is displayed, tap [CANCEL].

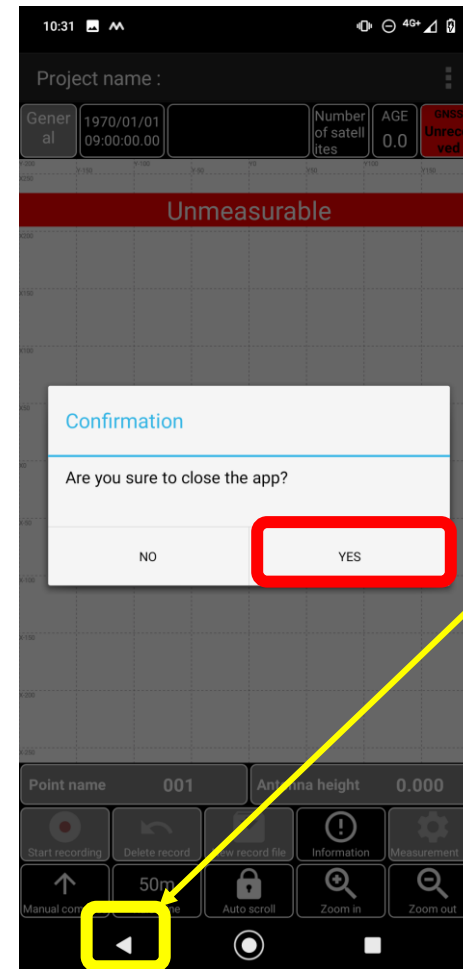

Tap the [◀] (Back) button and then [YES] to exit the application.

2-2. Installing SC Rover App

Migrate the [SC Rover App.db] and other files backed up after the installation.

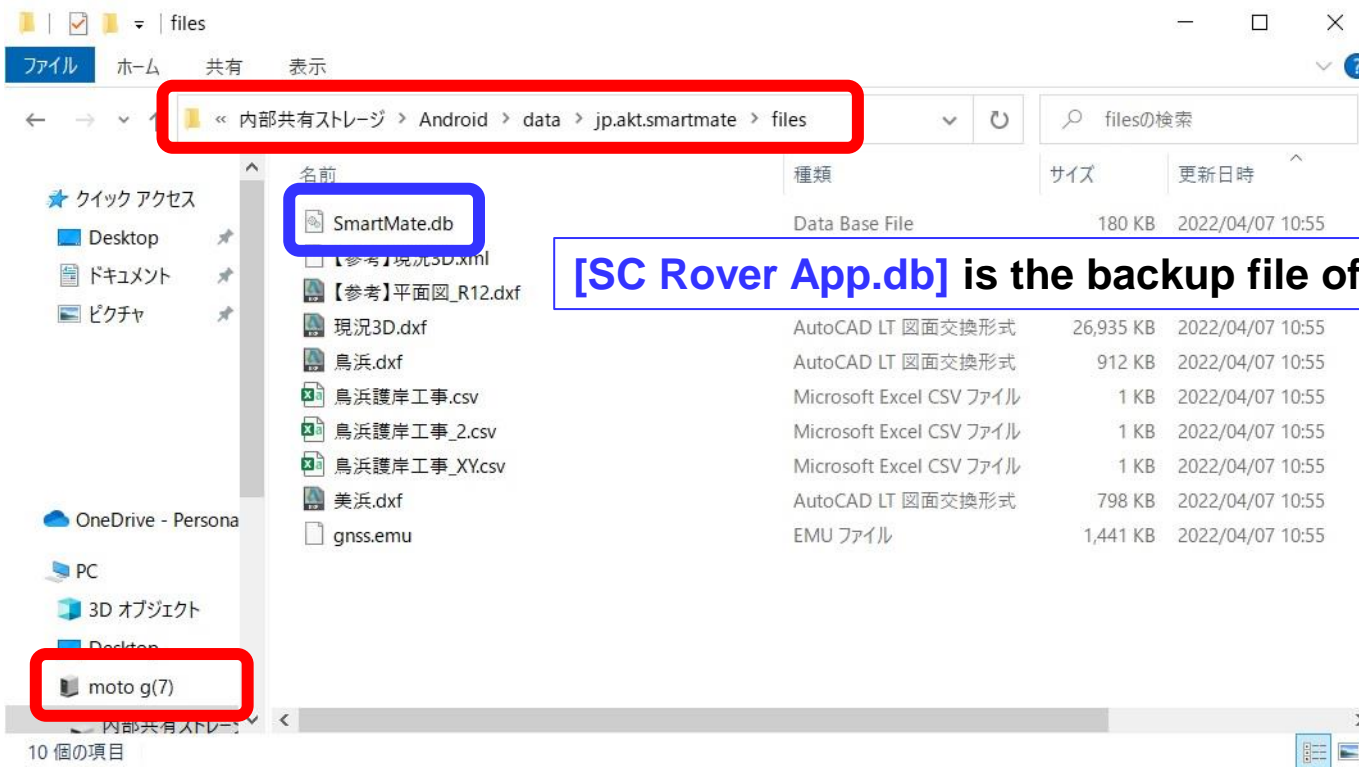

Connect the PC and the measurement terminal, and migrate (copy&paste) the [SC Rover App.db] and other files that have been backed up in the [internal shared storage > Android > data > jp.akt.SC Rover App > files folder](#).

2-2. Installing SC Rover App

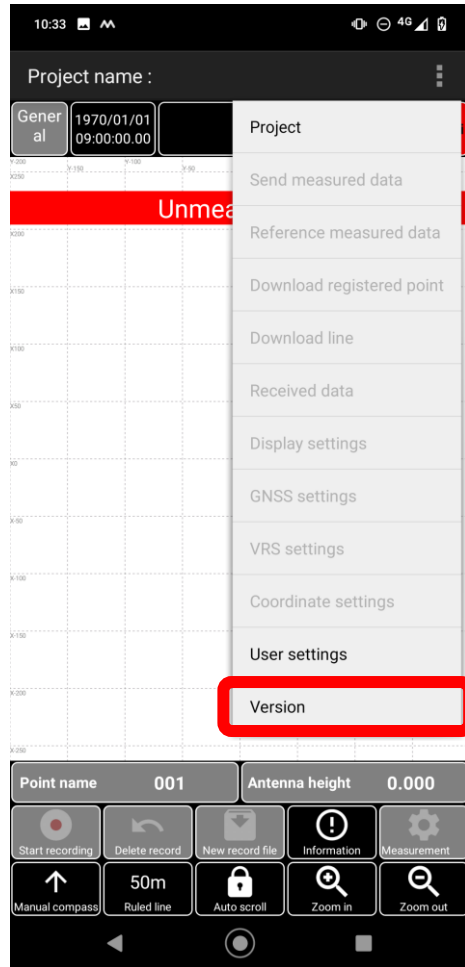

Tap [Version].

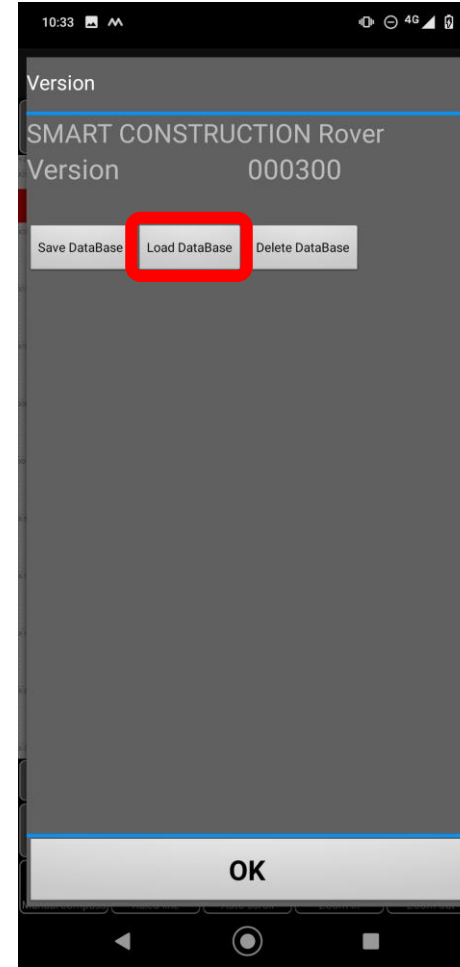

Tap [Load DataBase].

2-2. Installing SC Rover App

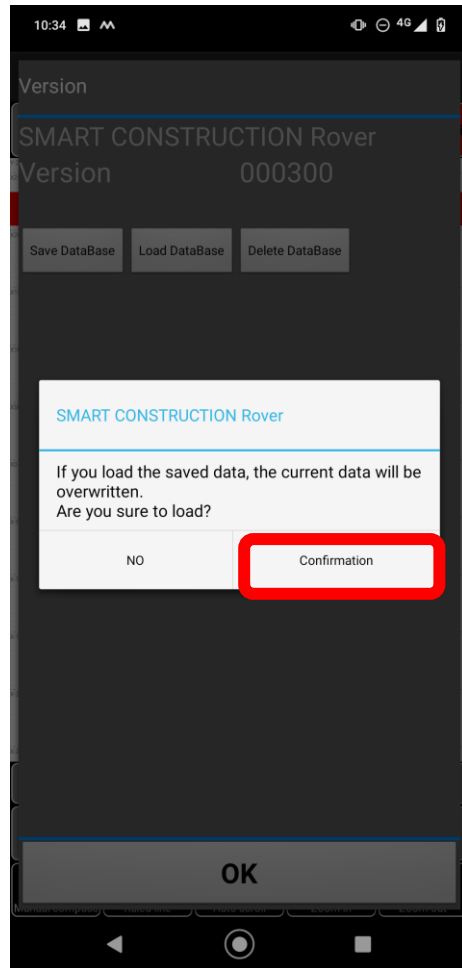

Tap
[Confirmation].

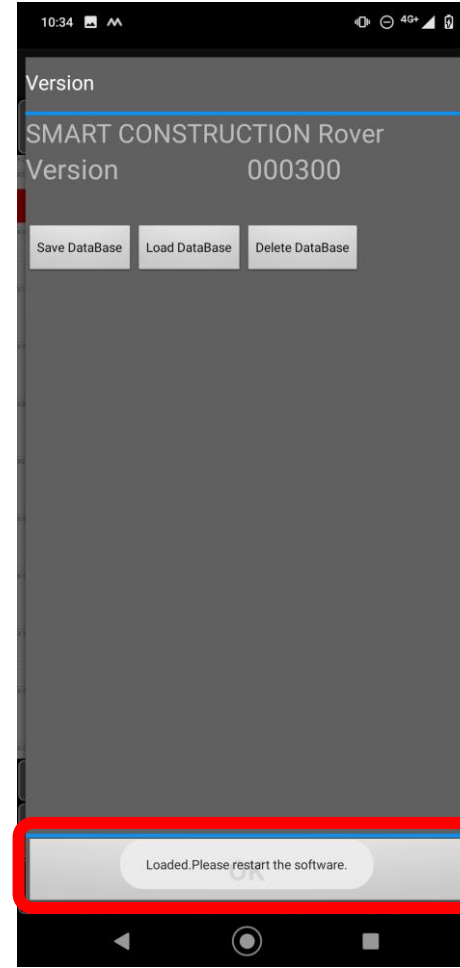

The backed up and migrated
measurement files are
imported.
Tap [OK].

2-2. Installing SC Rover App

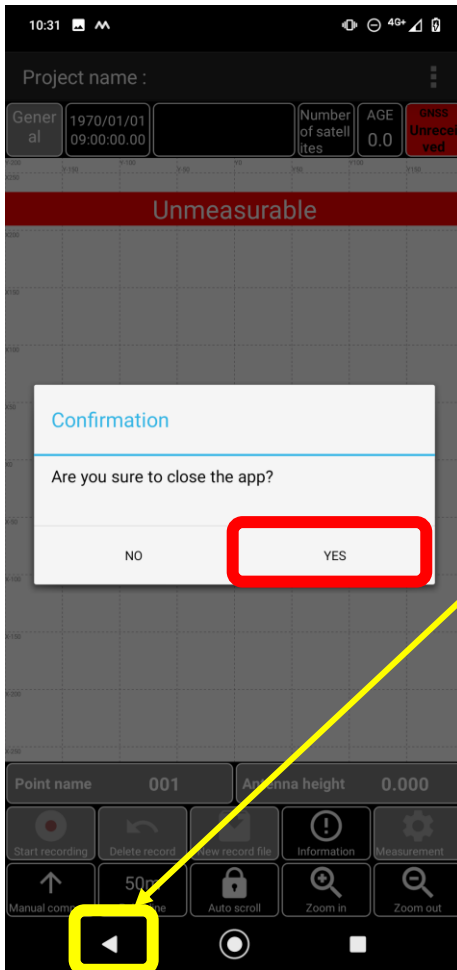

Restart the application.

Tap the [**◀**] (Back) button and then [**YES**] to exit the application.

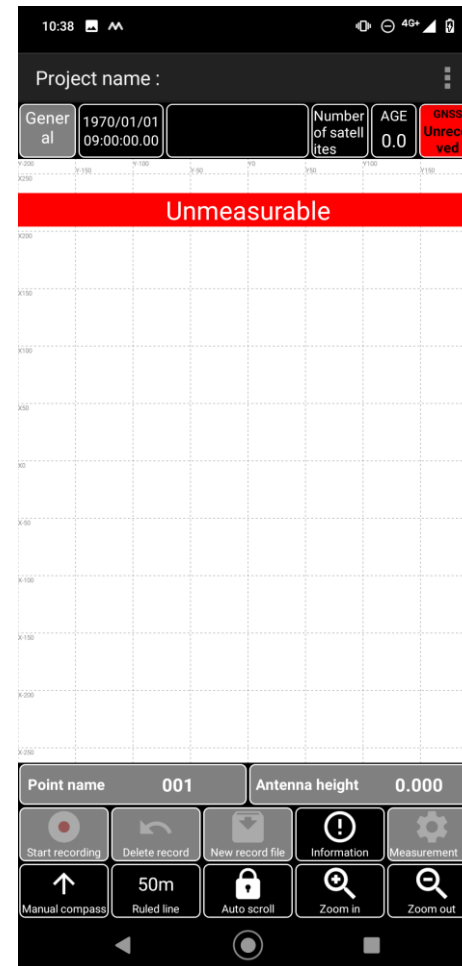

By starting the [SC Rover App], the measured data imported into each project is reflected.

Chapter 3

Pre-Setting for Measurement

3-1. Logging in to SC Rover App

SMARTCONSTRUCTION, SMARTCONSTRUCTION Pilot, and Quick3D users require LANDLOG authentication after logging in to SC Rover App.

3-1-1. Logging in to SC Rover App

You need to set it only once, on the first use. Not required for second use.

* Normally, this is set up by our company before delivery.

* We may ask you to change the settings, for example, due to contract changes.

Note

For products shipped in July 2022 and later, you may need to begin by setting the Google account and installing each application. To check this, refer to the procedure manual.

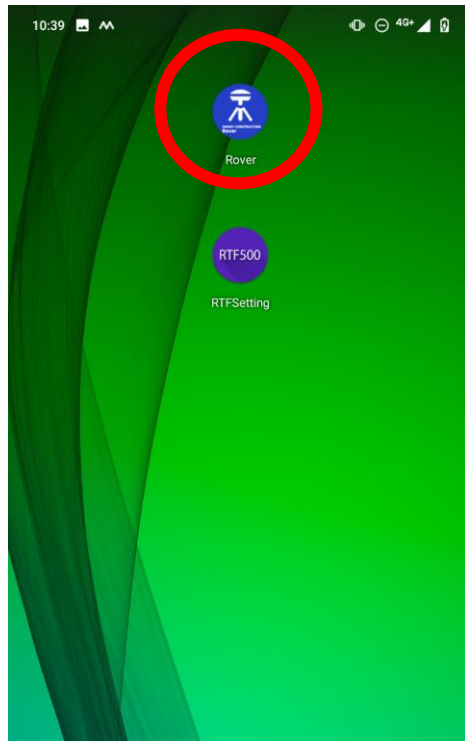

Power on your tablet and tap **[Rover]** to start it up.

* The location of the icon may differ from this picture depending on the terminal.

3-1-1. Logging in to SC Rover App

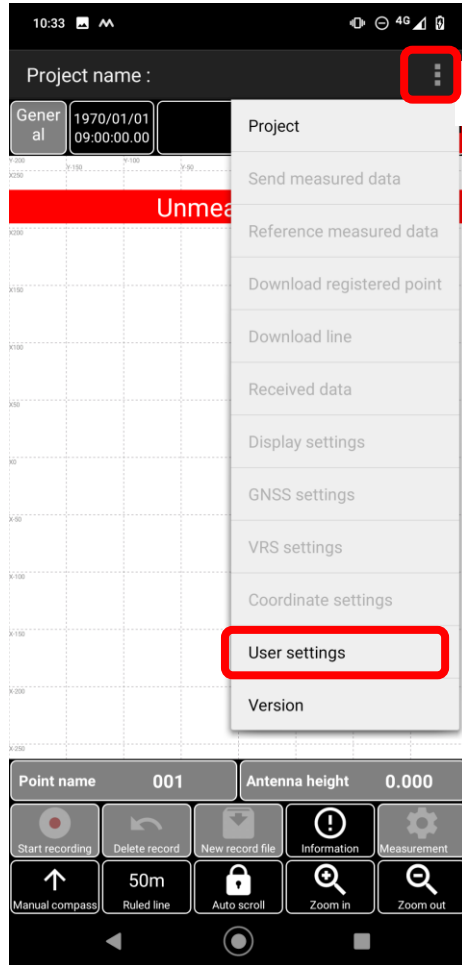

Tap the menu  and then **[User settings]**.

3-1-2. Logging in to LANDLOG

SMARTCONSTRUCTION
SMARTCONSTRUCTION Pilot
Quick3D

The users of these need to set the following.

* If you are not a user of SMARTCONSTRUCTION, SMARTCONSTRUCTION Pilot, or Quick3D, you do not need the settings (login).

You need to set it (login) only once, on the first use.

* Unless you change users, you do not need to log in to it again.
You may need to log in again, for example, if there is a change in specifications.

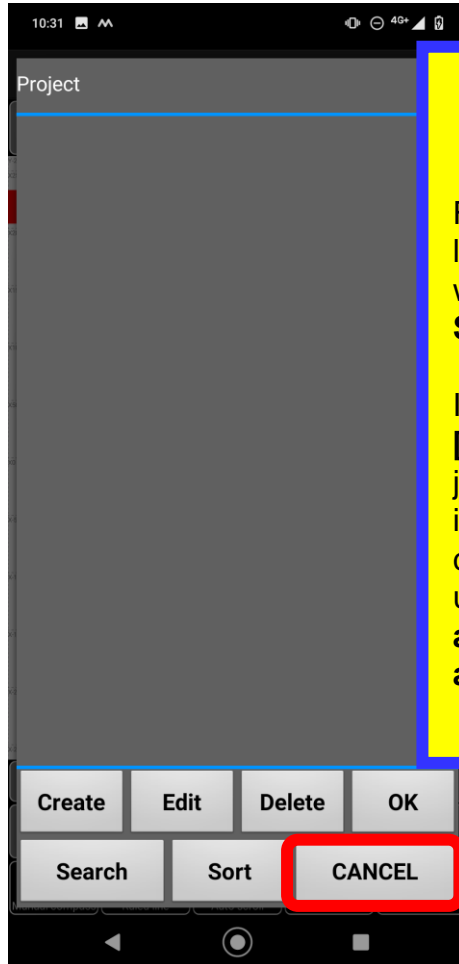

[Notes]

From **December 2020**, it can be linked also to jobsites created with the LANDLOG app [**Jobsite Setting**].

If it was authenticated to link a [**SMART CONSTRUCTION**] jobsite **before December 2020**, it cannot link to the jobsite created in [**Jobsite Setting**] unless **LANDLOG login authentication is performed again**.

When this screen appears, tap [**CANCEL**].

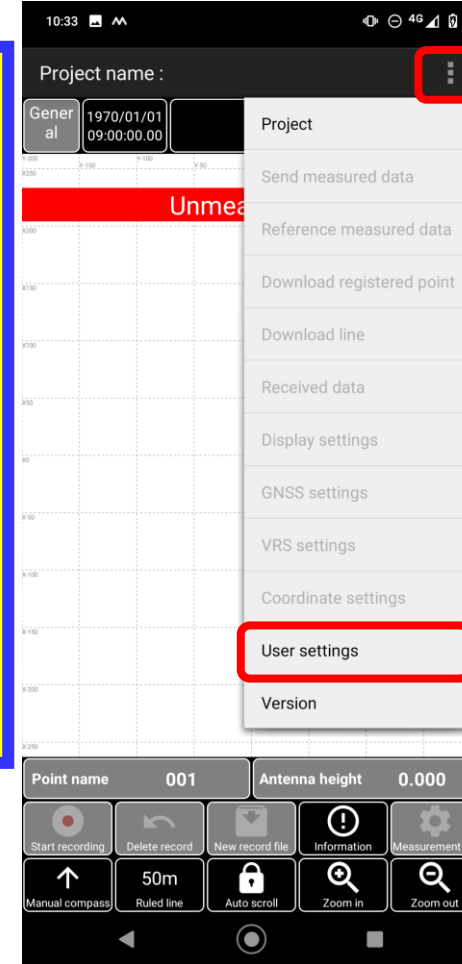

Tap the menu  and then [**User settings**].

3-1-2. Logging in to LANDLOG

SMARTCONSTRUCTION
SMARTCONSTRUCTION Pilot
Quick3D

The users of these need to set the following.

* If you are not a user of SMARTCONSTRUCTION, SMARTCONSTRUCTION Pilot, or Quick3D, you do not need the settings (login).

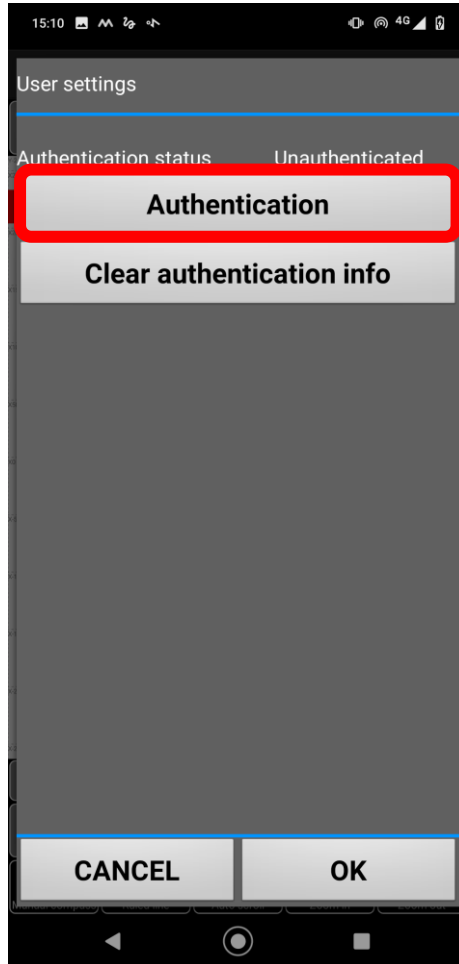

Tap
[Authentication].

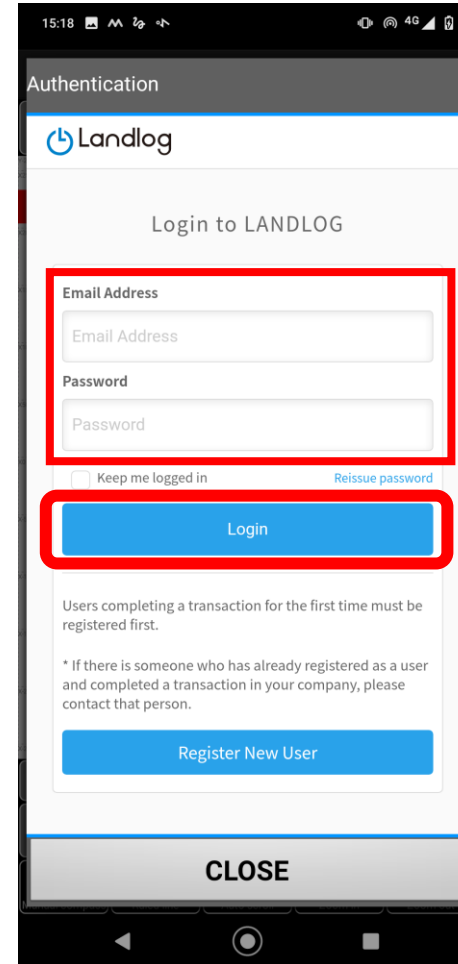

Enter your LANDLOG
authentication **email address**
and **password** and tap **[Login]**.

3-1-2. Logging in to LANDLOG

SMARTCONSTRUCTION
SMARTCONSTRUCTION Pilot
Quick3D

The users of these need to set the following.

* If you are not a user of SMARTCONSTRUCTION, SMARTCONSTRUCTION Pilot, or Quick3D, you do not need the settings (login).

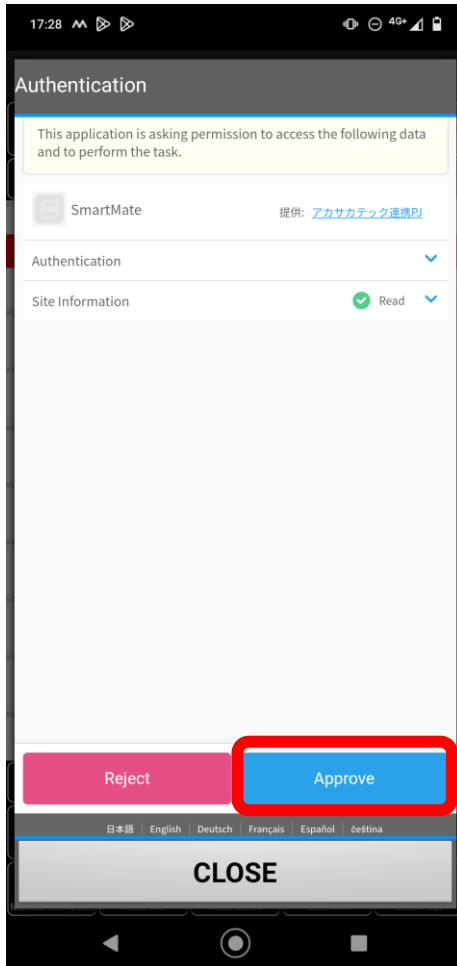

Other steps may be required before **[Approve]**.

If so, set them according to the procedure.

Tap **[Approve]**.

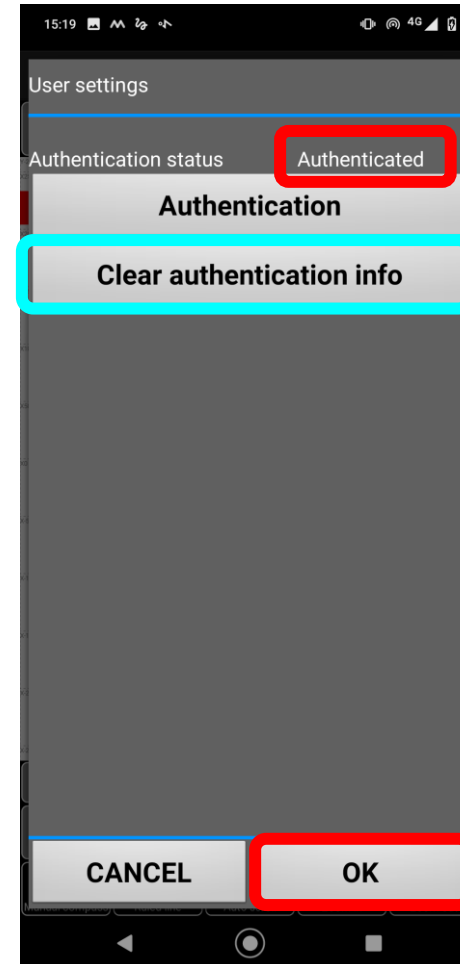

Confirm that it is authenticated successfully and the LANDLOG authentication status is **[Authenticated]**. Then tap **[OK]**.

To change a LANDLOG authenticated user, tap **[Clear authentication info]** and perform the authentication procedure again.

3-2. Creating a project

To perform the localization to create a GC3 file using Quick3D, you need to link the project created by SC Rover App to the LANDLOG work of [SMARTCONSTRUCTION] or [Jobsite Setting].

3-2-1. Creating a project

Create a project (site for measurement) with SC Rover App.

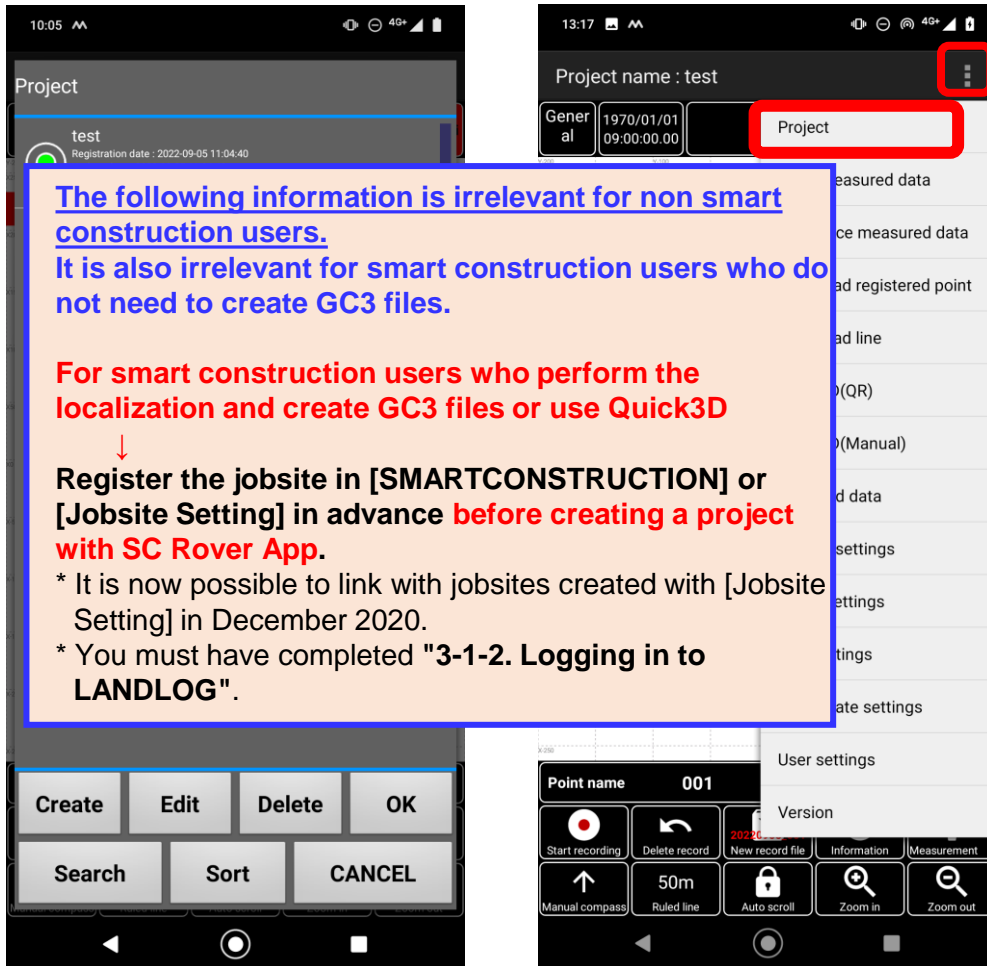

Tap the menu  and then [Project].



The [Project] menu is displayed.

* It lists the project names of those already created.

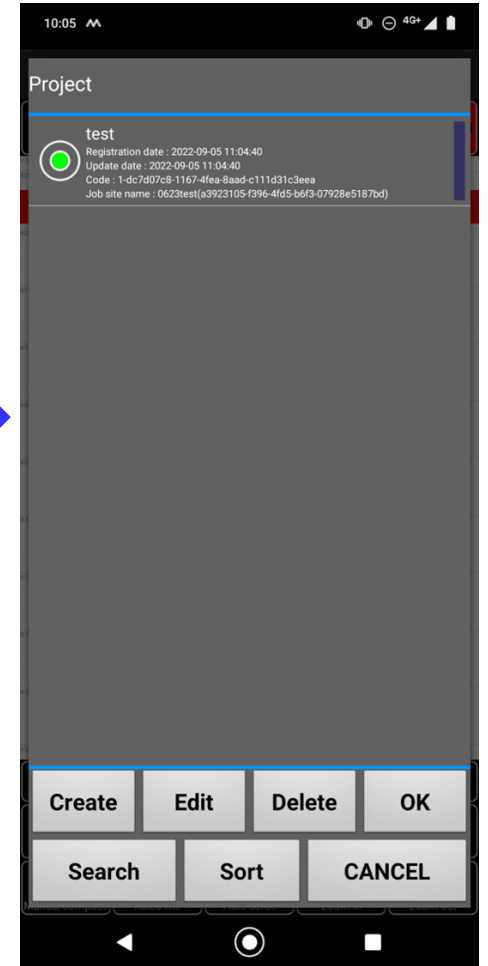

3-2-1. Creating a project

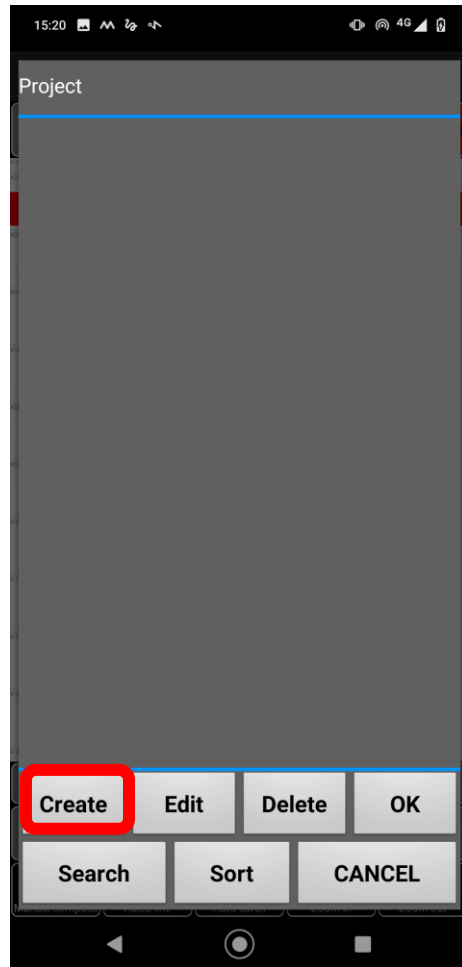

Tap [Create].

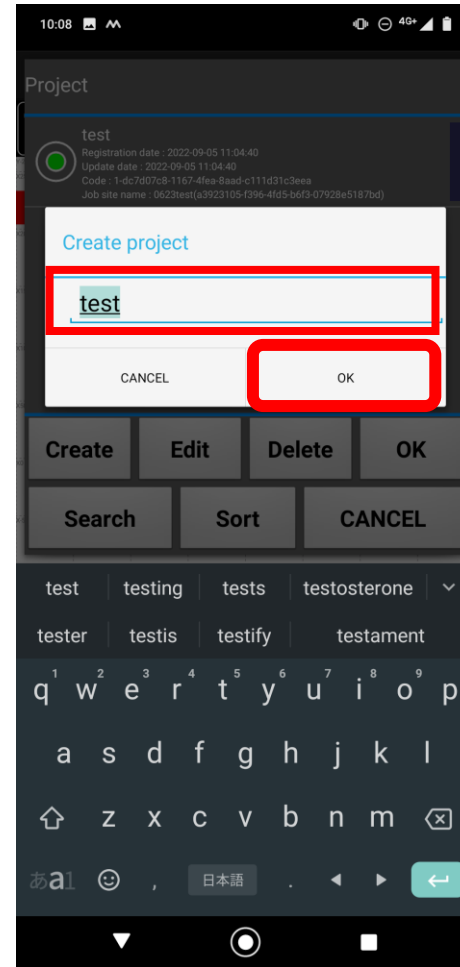

Enter a [project name] and tap [OK].

If you created a job site with [SMART CONSTRUCTION] or [Jobsite Setting], you should enter the same name as the jobsite name registered in [SMART CONSTRUCTION] or [Jobsite Setting].

* The names do not necessarily have to be the same. It can be linked even if the names are different. It is, however, recommended to enter the same name for easier management later.

It does not link to the [SMART CONSTRUCTION] or [Jobsite Setting] work name at this point. In this example, the project will be created on [SC Rover App].

3-2-1. Creating a project



The jobsite registration is finished.

Select the project to use and tap [OK].

* The screen on the right will not be displayed if you have not finished the LANDLOG authentication.

If you have finished the LANDLOG authentication

Even without linking to any LANDLOG work, you can register control points in the residual calculation terminal in localization.
→ GC3 files can be created by LANDLOG linking after measurement.



If the GC3 file is not created
If Quick3D is not used

Since it does not need to be linked to [SMART CONSTRUCTION] or [Jobsite Setting], tap [CANCEL].

If you are a smart construction user who has finished the LANDLOG authentication, the Select LANDLOG Work screen will appear.

- When creating a GC3 file by localization
If Quick3D is used
You need to link it to the LANDLOG work created with [SMART CONSTRUCTION] or [Jobsite Setting].
* See the next page.
- When not creating a GC3 file
If Quick3D is not used
Tap [CANCEL].

3-2-2. Linking to a LANDLOG work

To create a GC3 file with [Quick3D] by performing the localization, you need to link it to a project in [SMARTCONSTRUCTION] or [Jobsite Setting].

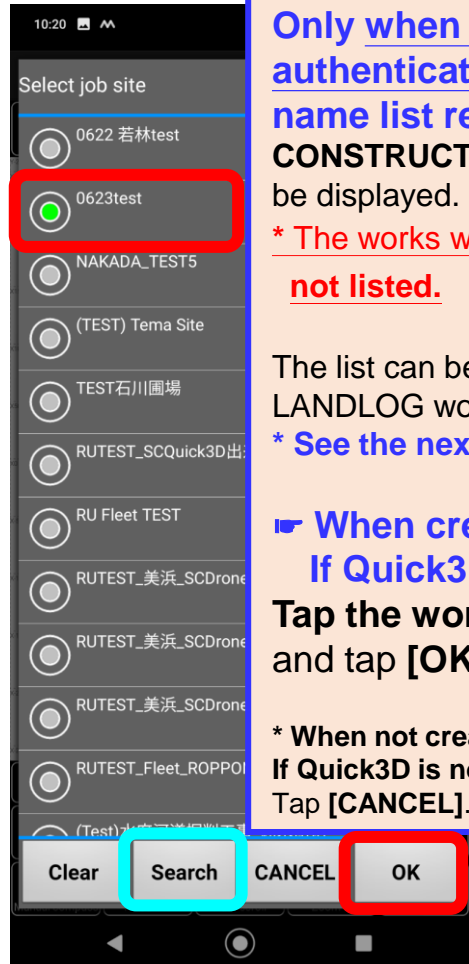

Only when the LANDLOG authentication is finished, the work name list registered in [SMART CONSTRUCTION] or [Jobsite Setting] will be displayed.

*** The works with work completed status are not listed.**

The list can be searched for your desired LANDLOG work.

*** See the next page.**

**When creating a GC3 file
If Quick3D is used**

Tap the work name to which to link it, and tap [OK].

*** When not creating a GC3 file
If Quick3D is not used**

Tap [CANCEL].

Note

Confirm that the screen shows the linked LANDLOG work name.

* Otherwise, they are not yet linked.
Retry the linking procedure.

Supplement

When creating a GC3 file, for the link between the SC Rover App project and LANDLOG work, it is possible to link them or change the link destination after measurement with the SC Rover App project.

Now, the project created with [SC Rover App] and the site registered with [SMART CONSTRUCTION] or [Jobsite Setting] will be linked.

Confirm that they are linked, and tap [OK].

For example, if you create a project named "1" as an [SC Rover App] project and select [test] in the Select LANDLOG Work screen, [SC Rover App] project "1" will be linked to that work.

3-2-3. LANDLOG work search

LANDLOG work search

* You can search for a work with Select LANDLOG Work (if there are many LANDLOG works registered).



To search for a LANDLOG work, tap **[Search]**.

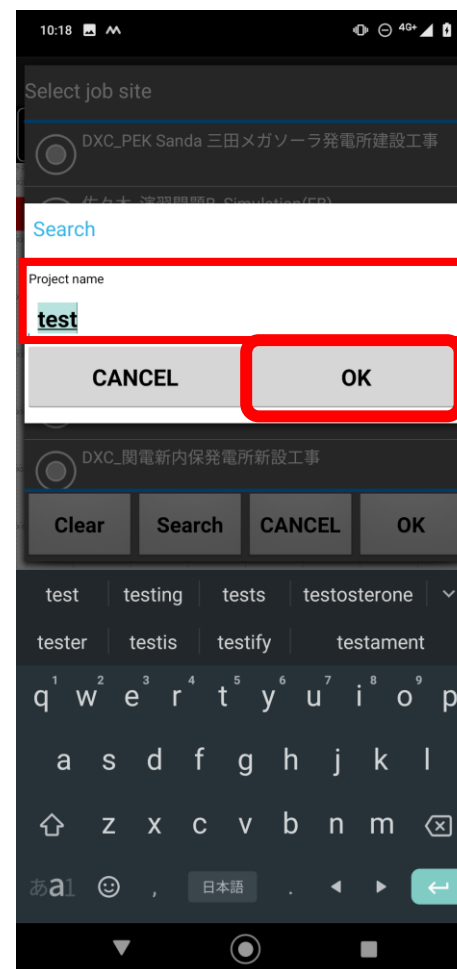

Enter the **LANDLOG work name** for which to search, and tap **[OK]**.

3-2-3. LANDLOG work search



The list includes the candidate LANDLOG work name entered in Search.

Select the work to which to link it, and tap [OK].



Note

Confirm that the screen displays the linked LANDLOG work name.
* Otherwise, they are not yet linked.
Retry the linking procedure.

Confirm that they are linked, and tap **[OK]**.

3-3. GNSS settings

3-3. GNSS settings

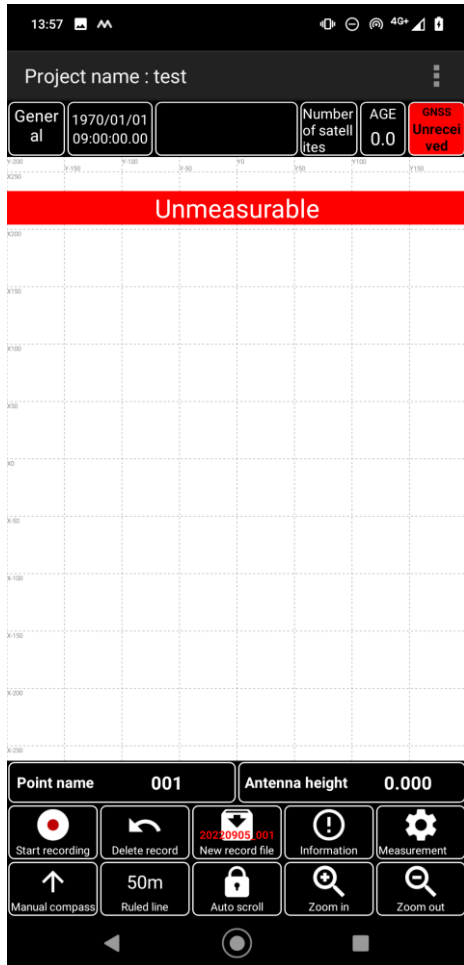

Start [SC Rover App]. If [GNSS] shows [Unreceived] is displayed, check [GNSS settings].

* If it is not [Unreceived] If [FIX], [FLOAT], or [SGPS] is displayed, the normal connection with the receiver can be judged to have succeeded and you can skip checking [GNSS settings].

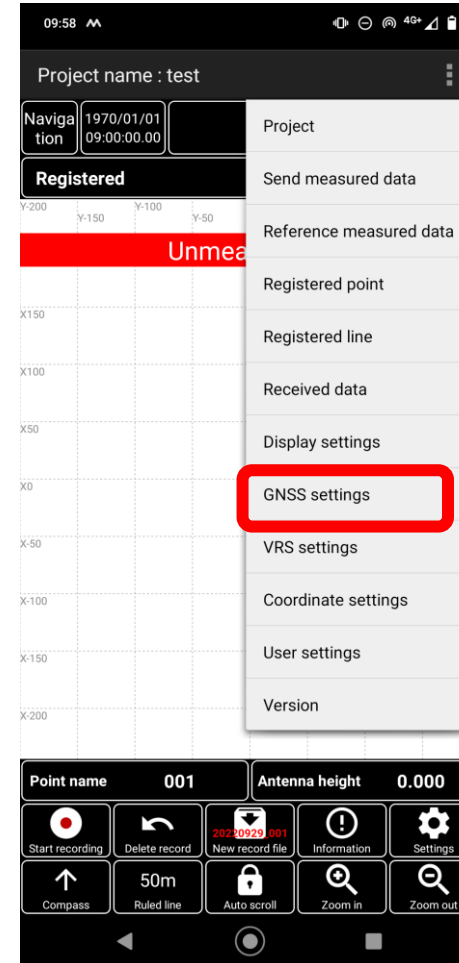

Tap the menu  and then [GNSS settings].

3-3. GNSS settings

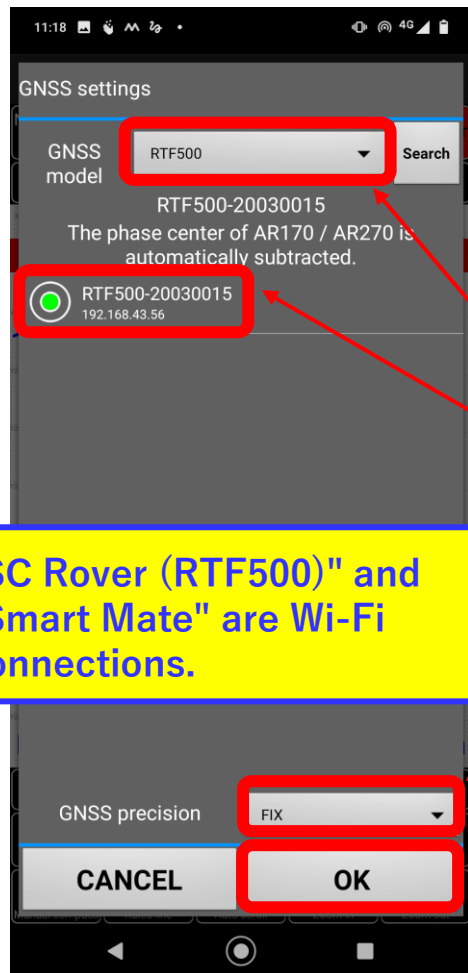

"SC Rover (RTF500)" and "Smart Mate" are Wi-Fi connections.

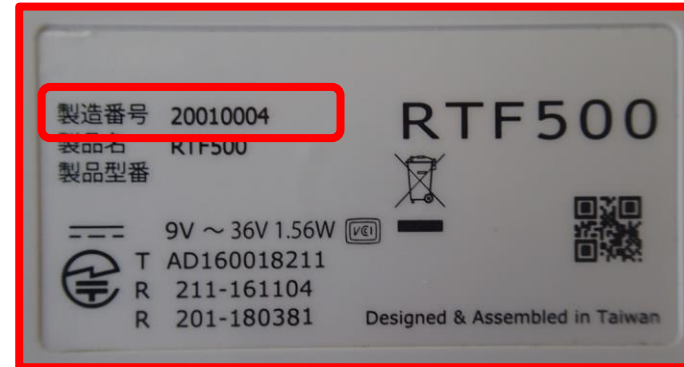

Select **[RTF500]** in **[GNSS Model]**.

After a while, **[RTF500-serial number]** paired (Wi-Fi client and AP setting) will be displayed.

* If the terminal and [SC Rover] are properly connected via Wi-Fi, tap the **[RTF500-serial number]** to use.

For GNSS effective accuracy, select **[FIX]** and tap **[OK]**.

* If the **[RTF500-serial number]** to use is not displayed Tap **[CANCEL]** and see the next page.

For Reference: If it is connected to GNSS but **[Unreceived]** results

* See "1-7. Precautions for using [SC Rover] also as a base station".

3-3. GNSS settings

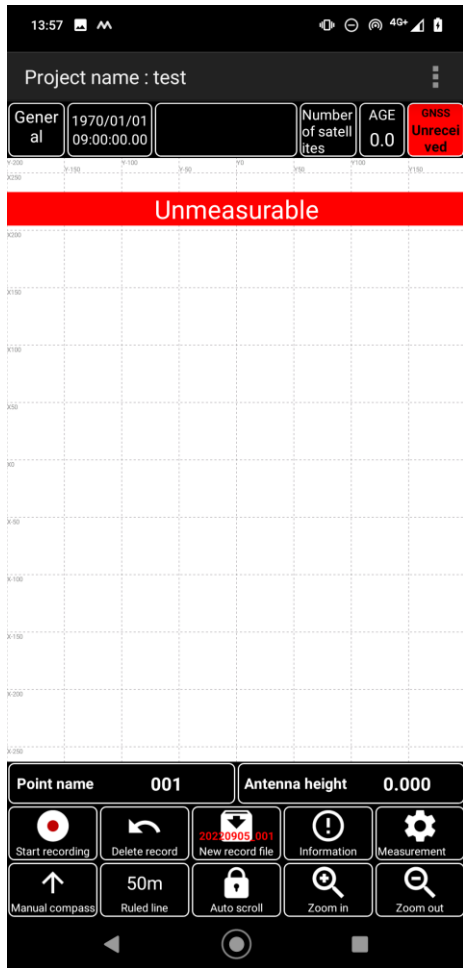

GNSS Unreceived

[GNSS] displays [Unreceived] even if the receiver is set in [GNSS settings].

Or if the serial number is not displayed during GNSS setting
*** See previous page.**

Close [SC Rover App] once and check the access point connection.

Swipe down from the top of the screen.

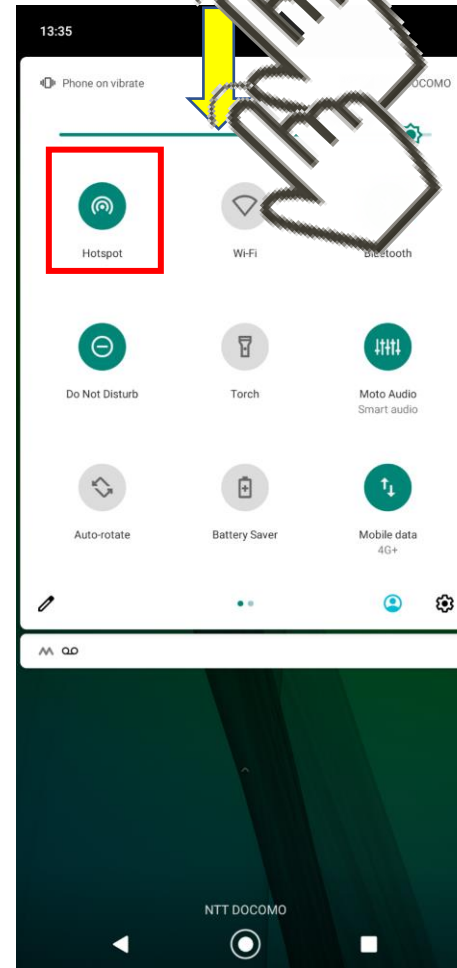

Turn On, Off, and then On the access point.

The access point connection is displayed.

When it is **On (green icon)**, tap the icon to turn it **Off (gray icon)** and tap the icon again to turn it **On (green icon)**.

When it is On (green icon), **start [SC Rover App].**

3-4. Ntrip settings

3-4-1. Ntrip settings

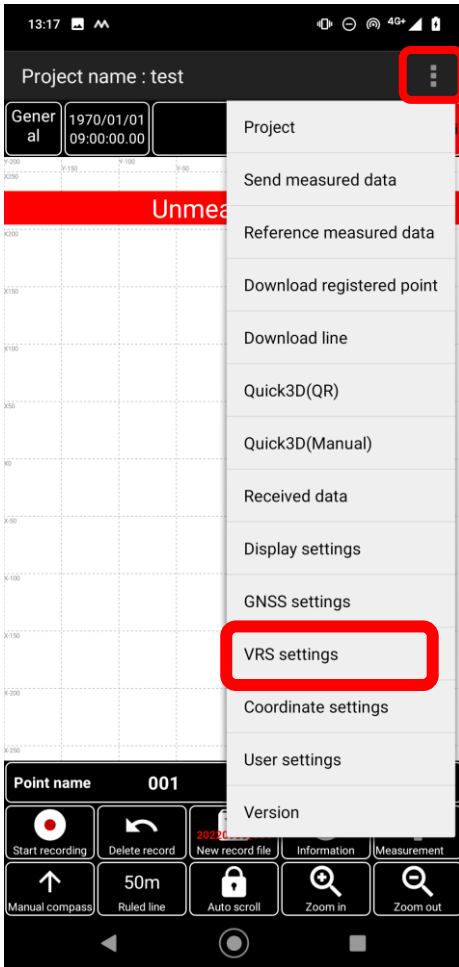

Tap the menu  and then [VRS settings].

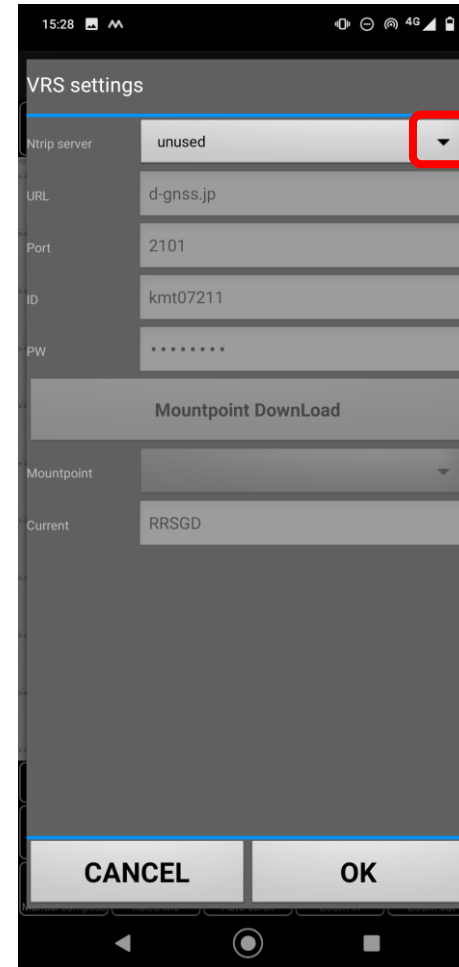

Tap [>] and select [used].

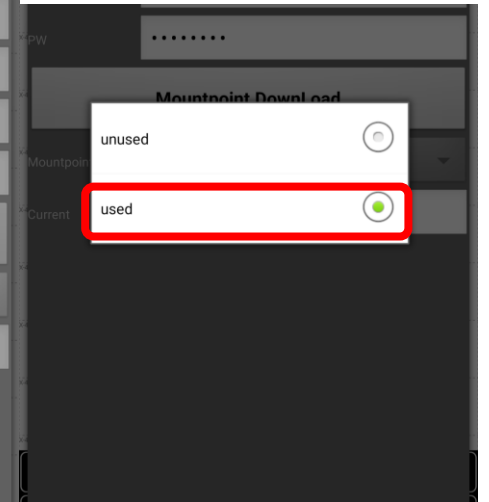

3-4-1. Ntrip settings

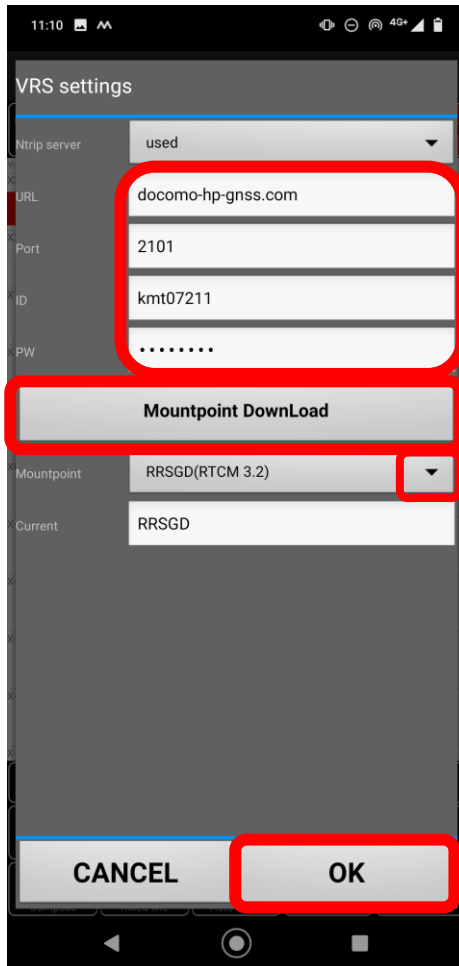

Enter the **[URL]** and **[Port]** of the destination party and the **[ID]** and **[PW]** issued by the contracted company.

Tap **[Mount Point DownLoad]**.

Tap **[▼]** and select the mount point to use.

* For the mount point of each company, examine it in a separate document.

After confirming the settings, tap **[OK]**.

3-5. Coordinate settings

3-5-1. Measurement with a projection

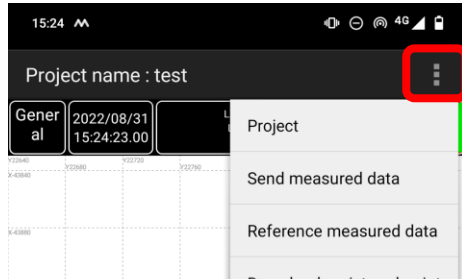

Tap the menu  and then **[Coordinate settings]**.

The use of Ntrip lets you perform the measurement in the world geodetic system.

Ntrip does not enable measurement in the old Japanese geodetic system.

For performing the localization, see the next page.

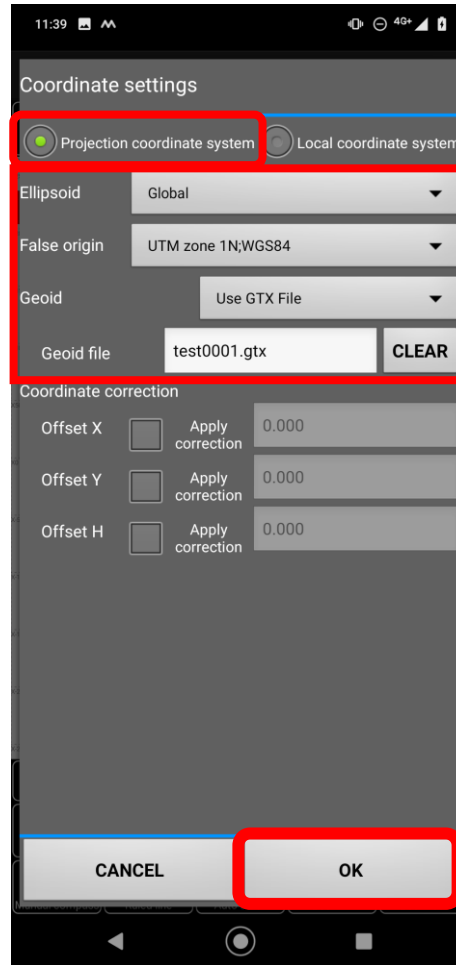
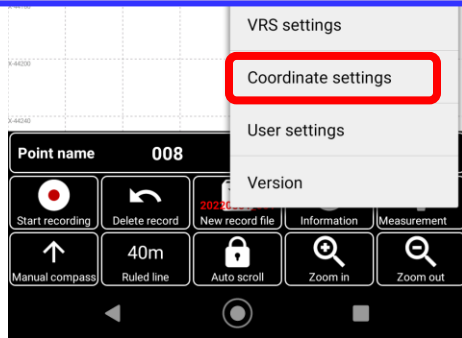

Select a projection.

- [Ellipsoid]
Select the region where to use it

- [False origin]
Select **[Public coordinate system to use]**.

- [Geoid]
Select **[Use GTX File]**.

- [Geoid file]
Select the **[GTX file to use]** saved on the terminal.

After confirmation, tap **[OK]**.

3-5-2. Performing localization

1. Registering the reference point coordinates (for performing the localization by actual measurement)

Before localization measurement, pre-register the reference point coordinates (X, Y, H) for localization in the terminal.

* Importable with a CSV file.

2. Reflecting the localization results measured by a competitor's system

After importing the CSV file of the X, Y, and H coordinates of each point, WGS84 latitude, longitude, and ellipsoidal height, which are the results of localization by the competitor's system (e.g. GC3 file), the residual calculation can be performed with Smart Construction Rover App and the result can be registered as a control point.

* Supported by Ver. 000033 or later of [SC Rover App].

Example of use:

The jobsite has already completed the localization with the competitor's system and has the resulting localization file (e.g. *.GC3). At this site, you want to reflect the results of the localization previously performed by the competitor's system in the [SC Rover App] and perform measurement without actually measuring the localization again.

3-5-2-1. Registering the reference point coordinates

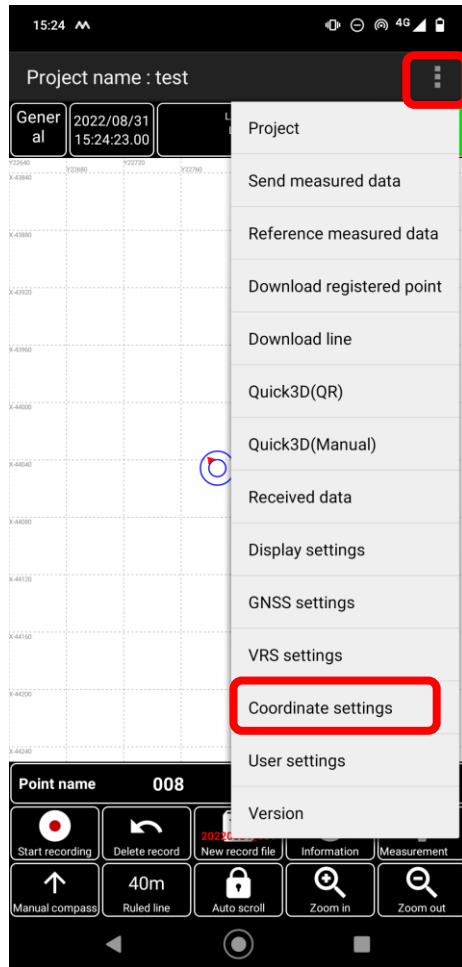

Tap the menu  and then **[Coordinate settings]**.

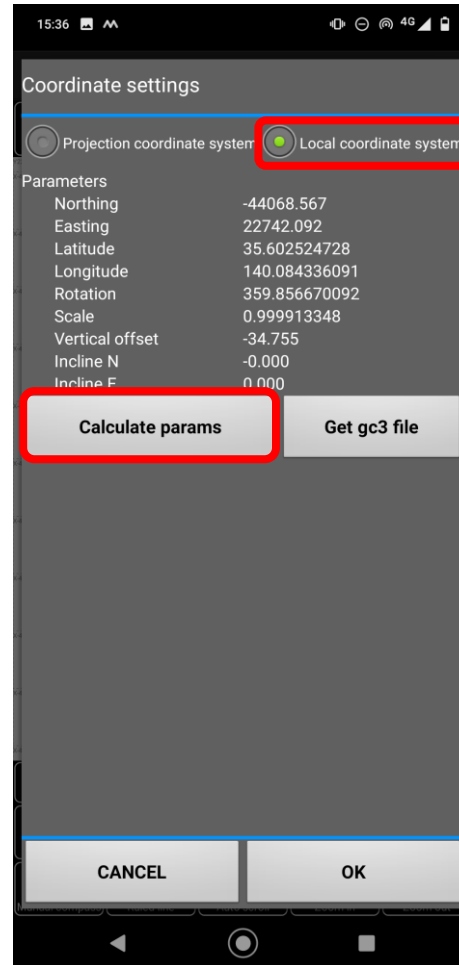

Tap **[Local coordinate system]**.

Tap **[Calculate params]**.

3-5-2-1. Registering the reference point coordinates

Register the reference point coordinates

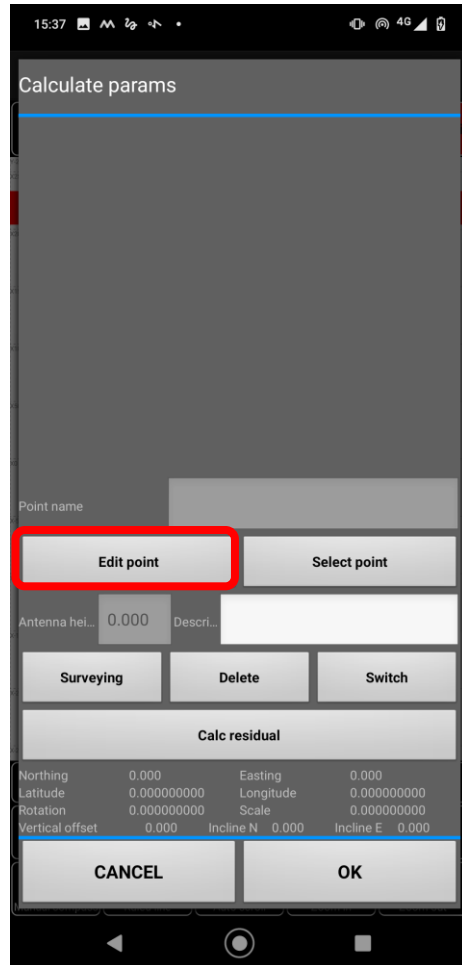

Tapping the **[Edit point]** button opens the Edit Point screen.
* That screen allows you to **[Add]**, **[Edit]**, and **[Delete]** the point.



■ For manual input

Point coordinates where the localization measurement will be made

Enter

- [Point name],
- Local coordinate n [m]: X,
- Local coordinate e [m]: Y, and
- Local coordinate z [m]: Z.

Then tap **[Add]**.

After entering these in order, tap **[Add]**.

The reference point coordinates to register (i.e. targets of actual measurement) can be imported with a CSV format file.

* See the next page.

3-5-2-1. Registering the reference point coordinates

Importing the reference point coordinate file

Import the X, Y, and H coordinates actually measured in localization with a CSV file.

The format of the file to be imported must be as follows.

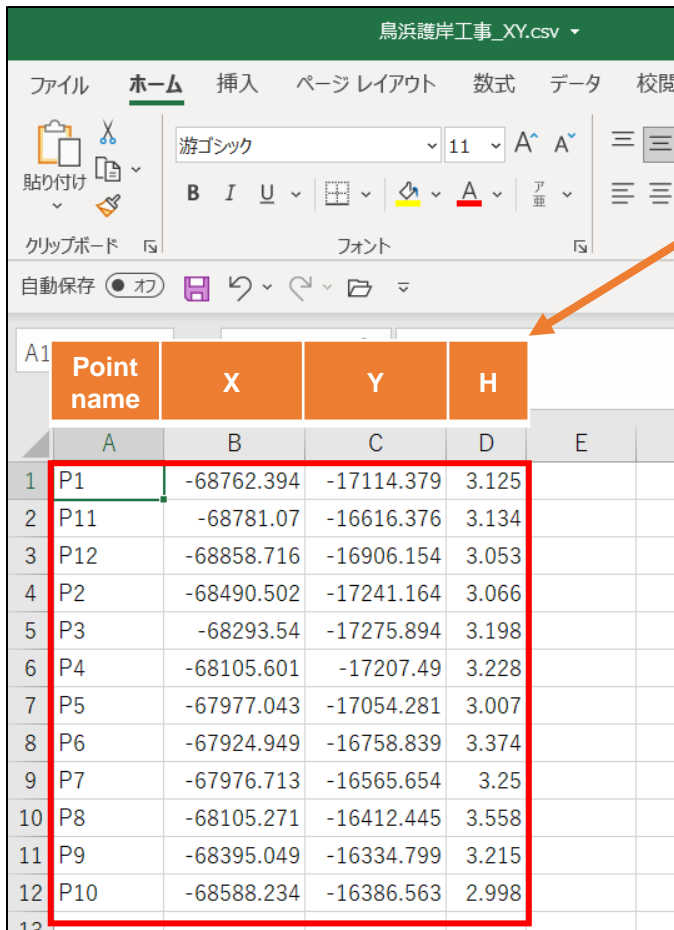

	Point name	X	Y	H
	A	B	C	D
1	P1	-68762.394	-17114.379	3.125
2	P11	-68781.07	-16616.376	3.134
3	P12	-68858.716	-16906.154	3.053
4	P2	-68490.502	-17241.164	3.066
5	P3	-68293.54	-17275.894	3.198
6	P4	-68105.601	-17207.49	3.228
7	P5	-67977.043	-17054.281	3.007
8	P6	-67924.949	-16758.839	3.374
9	P7	-67976.713	-16565.654	3.25
10	P8	-68105.271	-16412.445	3.558
11	P9	-68395.049	-16334.799	3.215
12	P10	-68588.234	-16386.563	2.998

CSV (comma-separated values) files (*.csv) can be imported.

The data is listed as shown on the left and saved as a **CSV (comma-separated values) file (*.csv)**.

Example) Creation with Microsoft Excel

A: Point name; B: X; C: Y; D: H

Note

If saved as a **CSV (comma-separated values) UTF-8 file (*.csv)**, it cannot be imported.

▮ Migrate the importing destination file to the specified folder on the terminal in advance.

▶ Specified folder

Internal Shared Storage/Android/data/jp.akt.SC Rover App/files.

* From Ver. 000200, the importing is now enabled from external storage (e.g. SD card, USB flash drive).

See 3-5-2-2, "(3) Copying and pasting the CSV file to the terminal".

3-5-2-1. Registering the reference point coordinates

Importing the reference point coordinate file

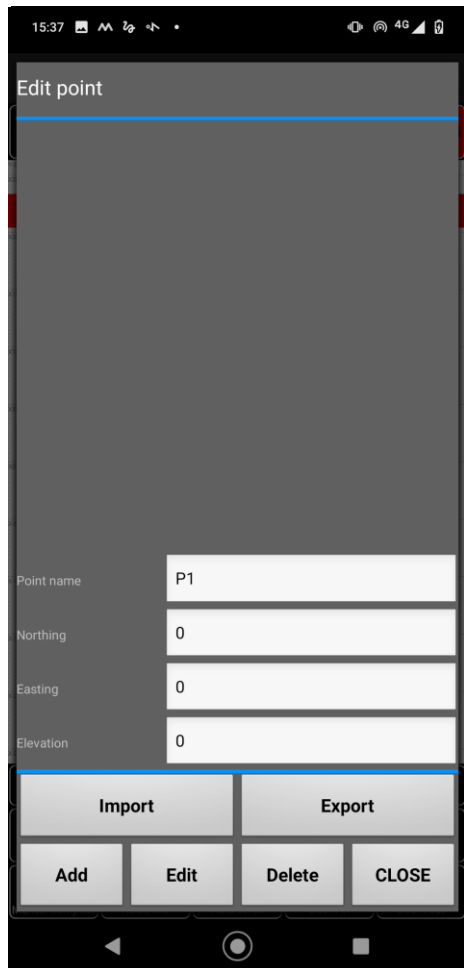

Select [Local coordinate system] → [Calculate params] → [Edit point]. Then tap [Import].

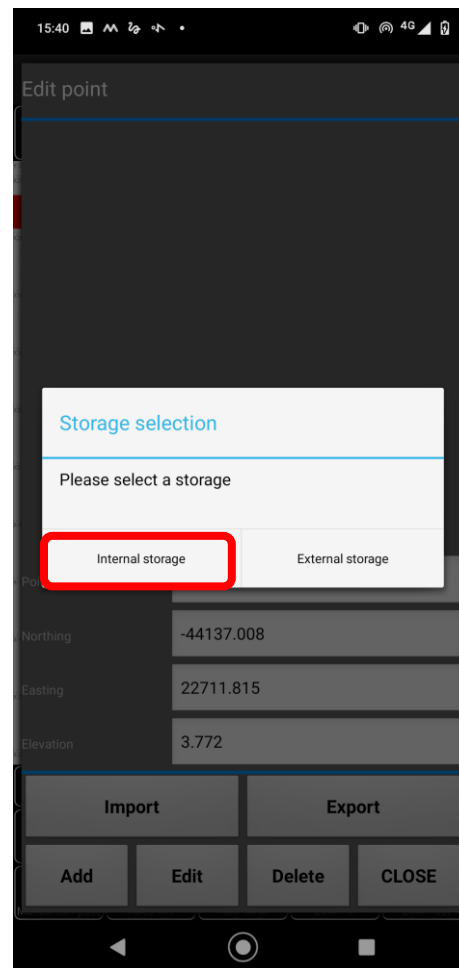

Select and tap [**Internal storage**] or [**External storage**] for the destination location to which to import the file.

* **Specified importing destination folder in internal storage**
Internal Shared Storage/Android/data/ip.akt.SC Rover App/files

* **External storage**
SD card, USB flash drive, etc.

3-5-2-1. Registering the reference point coordinates

Importing the reference point coordinate file

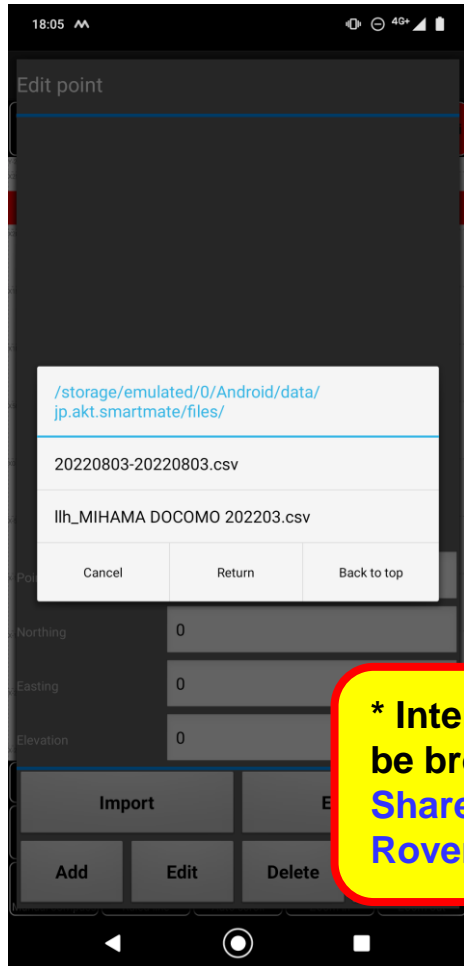

Note

Select the ***.csv** file you created.
Ver. 000100 or later restricts the folders in which files can be browsed in **internal storage**.

*** Internal storage in which the file can be browsed is limited to Internal Shared Storage/Android/data/jp.akt.SC Rover App/files.**

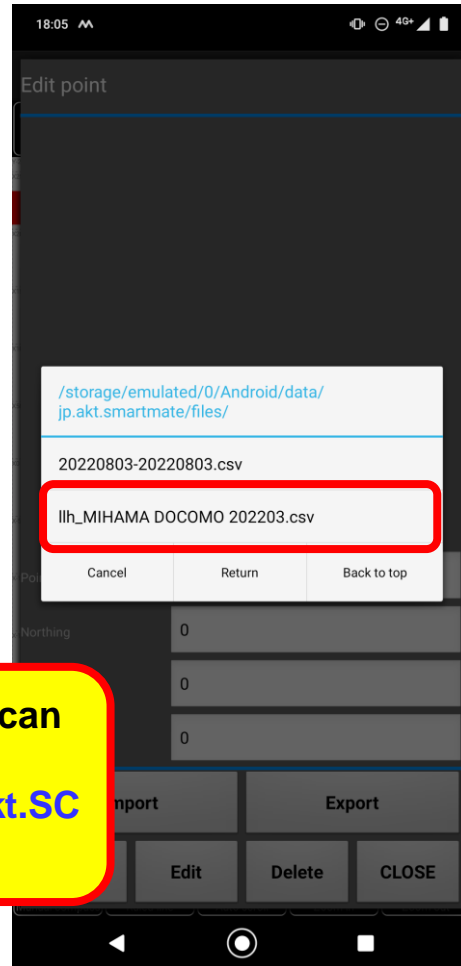

Tap the importing destination ***.csv** file.

3-5-2-1. Registering the reference point coordinates

Importing the reference point coordinate file

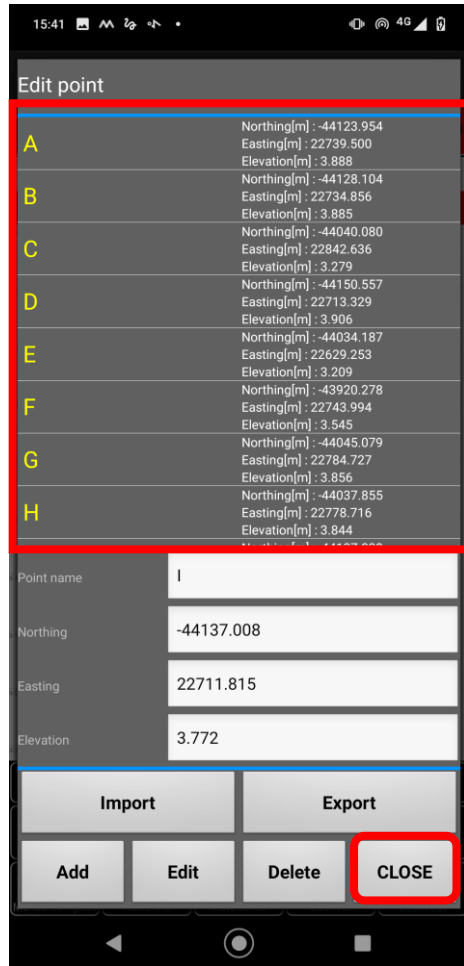

Confirm that it was imported, and tap **[CLOSE]**.

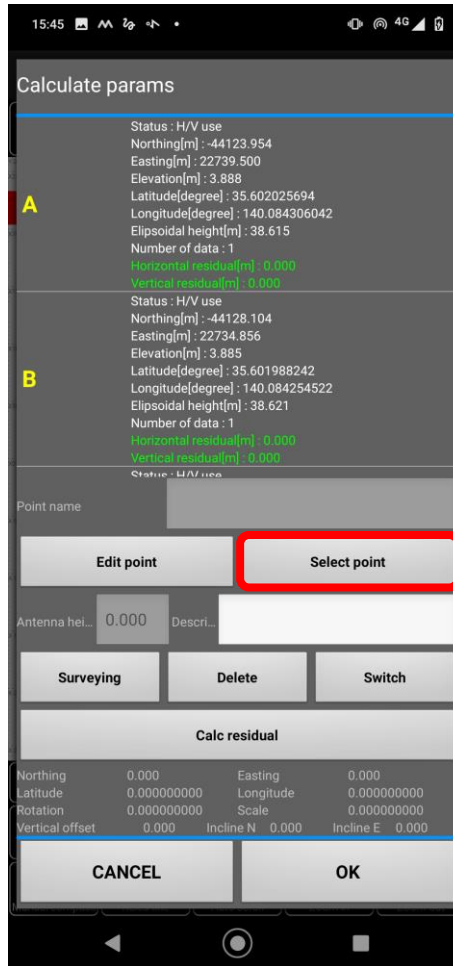

Tap **[Select point]**.

3-5-2-1. Registering the reference point coordinates

Importing the reference point coordinate file



Check the imported reference point coordinates. Then, confirm that the coordinates in the file have been imported, and tap **[CANCEL]**.

Localization actual measurement

Make an actual measurement with the imported reference point.

* For localization actual measurement, see "**Chapter 5 Localization**".

3-5-2-2. Reflecting the localization results measured by a competitor's system

Reflect the localization results measured by a competitor's system.

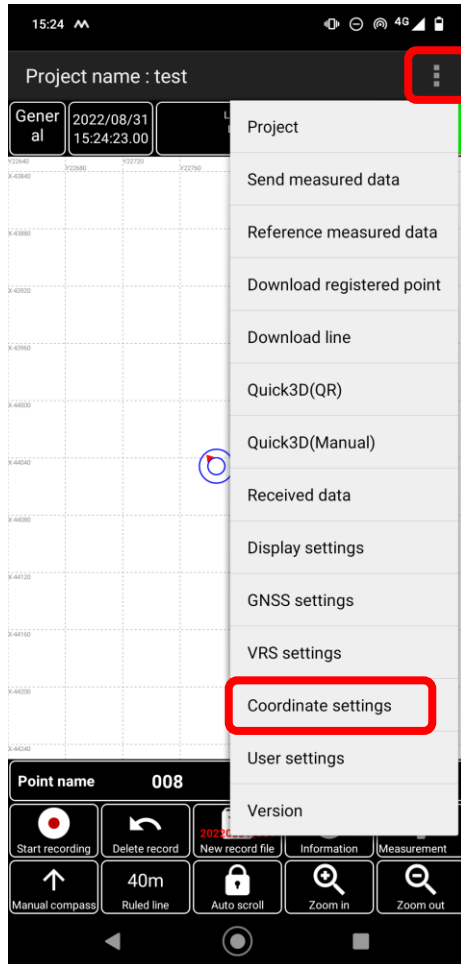

Tap the menu  and then **[Coordinate settings]**.

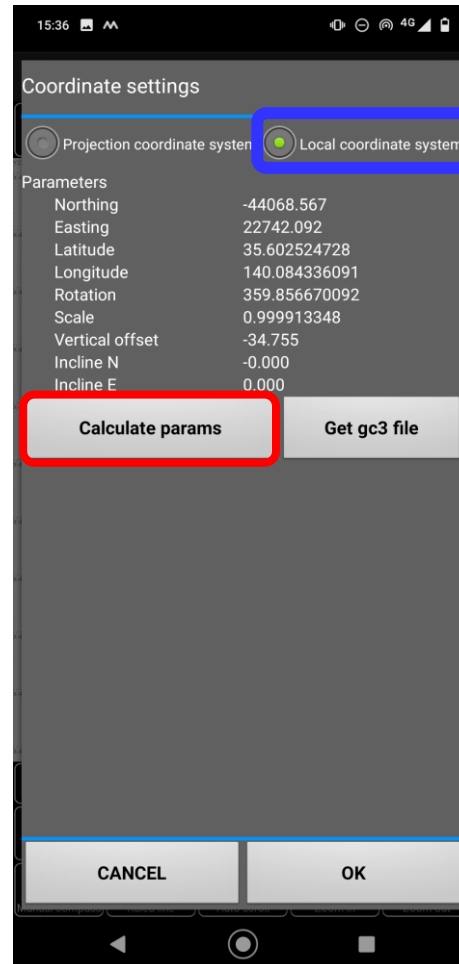

Tap **[Local coordinate system]**.

Tap **[Calculate params]**.

3-5-2-2. Reflecting the localization results measured by a competitor's system

The format of the destination file to which to import the localization results measured by the competitor's system

Notes

From [SC Rover App] Ver. 000033, the **latitude and longitude** that are imported and exported from the file are in **sexagesimal notation (deg/min/s)**.

Be careful that the specification has been changed from Ver. 000033.

The **latitudes and longitudes** exported with a version **earlier than 000033** are in **decimal notation (deg)**.

* If a file exported with a version earlier than 000033 is imported with Ver. 000033 or later, differences will arise.

The format of the file to be imported must be as follows.

CSV (comma-separated values) files (*.csv) can be imported.

Point name	X	Y	H	Latitude * Sexagesimal	Longitude * Sexagesimal	Ellipsoidal height
P1	-68762.394	-17114.379	3.125	35.224817724	139.384186722	40.89
P11	-68781.07	-16616.376	3.134	35.224760148	139.390160158	40.87
P12	-68858.716	-16906.154	3.053	35.224506426	139.385012532	40.8
P2	-68490.502	-17241.164	3.066	35.225699250	139.383682296	40.84
P3	-68293.54	-17275.894	3.198	35.230338220	139.383543174	40.97
P4	-68105.601	-17207.49	3.228	35.230948486	139.383812814	40.99
P5	-67977.043	-17054.281	3.007	35.231366638	139.384418994	40.77
P6	-67924.949	-16758.839	3.374	35.231537494	139.385589348	41.1
P7	-67976.713	-16565.654	3.25	35.231370658	139.390355236	40.97
P8	-68105.271	-16412.445	3.558	35.230954390	139.390963306	41.28
P9	-68395.049	-16334.799	3.215	35.230014514	139.391273068	40.92
P10	-68588.234	-16386.563	2.998	35.225387280	139.391069320	40.72

Note If saved as a **CSV (comma-separated values) UTF-8 file (*.csv)**, it cannot be imported.

The data is listed as shown on the left and saved as a CSV (comma-separated values) file (*.csv).

Example) Creation with Microsoft Excel

A: Point name; B: X; C: Y; D: Z; E: Latitude; F: Longitude; G: Ellipsoidal height

Sexagesimal latitude and longitude input values
 Examples) Latitude: 35°02'48.17724"
 DD.MMSSSSSSS -> 35.024817724
 Longitude: 139°38'41.86722"
 DDD.MMSSSSSSS -> 139.384186722

Migrate the desired importing destination file to the **specified folder on the terminal** in advance.

* **Specified folder:** Internal Shared Storage/Android/data/jp.akt.SC Rover App/files

See 3-5-2-2, "(3) Copying and pasting the CSV file to the terminal".

3-5-2-2. Reflecting the localization results measured by a competitor's system

Example) Reflecting the GC3 file measured by the TOPCON system to the [SC Rover App].

* The jobsite already has a GC3 file of the results measured using the TOPCON system.

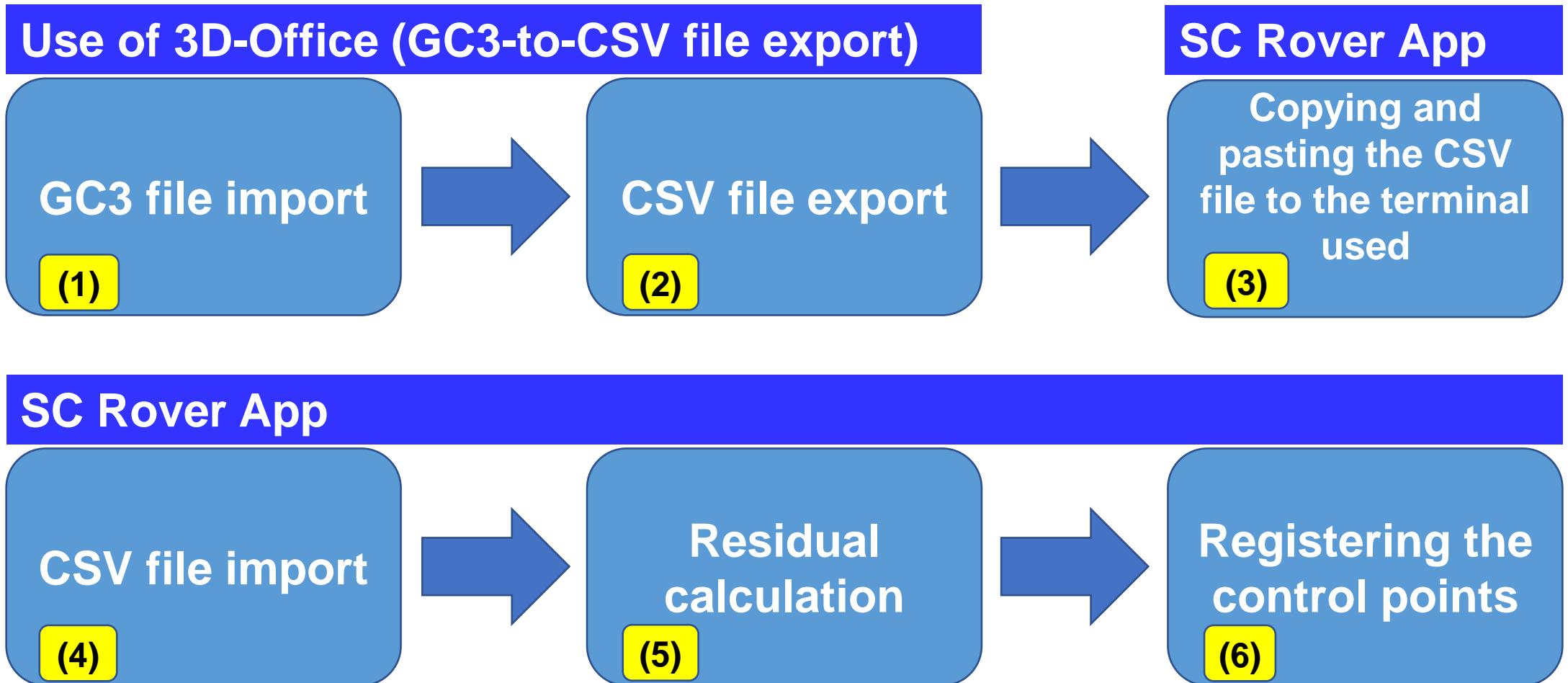

3-5-2-2. Reflecting the localization results measured by a competitor's system

(1) GC3 file import

3D-Office

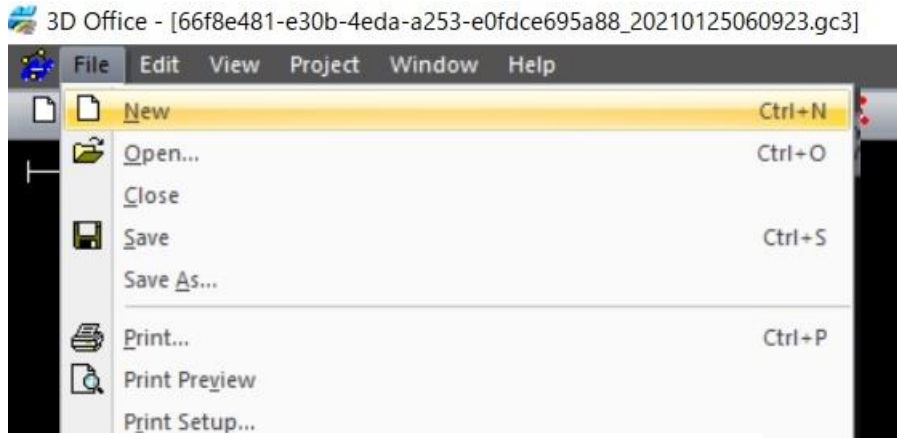

Select **File > New**

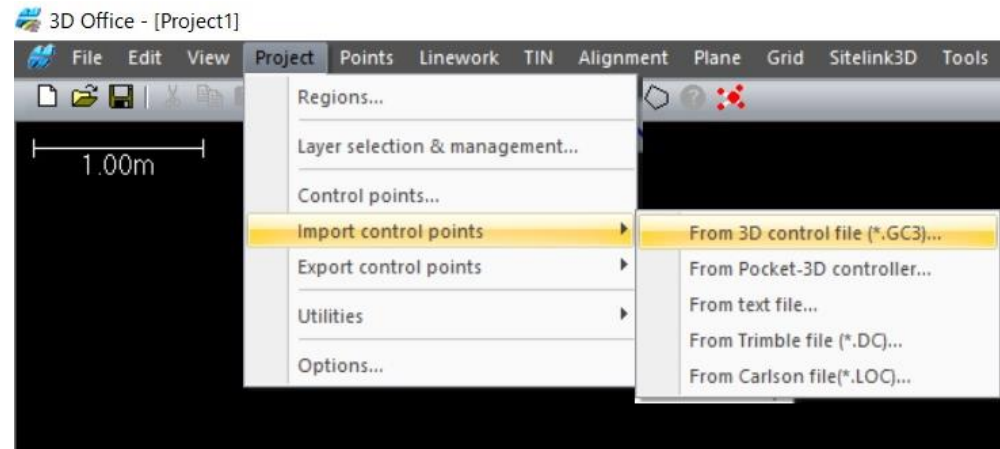

Select **Project > Import Control Point > From 3D control file (*.GC3)**

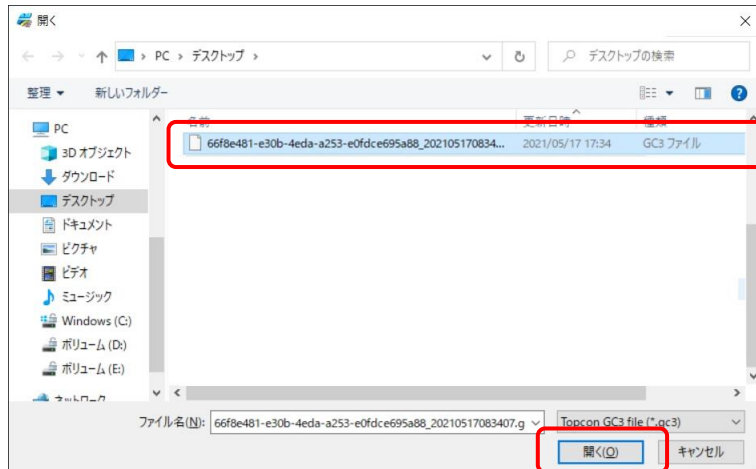

Select and [Open] the GC3 file.



[Yes]

3-5-2-2. Reflecting the localization results measured by a competitor's system

(1) GC3 file import

3D-Office

161m

P1, P2, P3, P4, P5, P6, P7, P8, P9, P10, P11, P12

Name	IP	Type	Sub Type	Operator	Task	Material	Activity	Active Project	Design Surface	Design Offset	Alignment	As-Built Surface	X	Y
Confirm that the points have been imported.														

Ready | Sitelink3D not Available | X: -16839.0739m | Y: -68578.1362m

3-5-2-2. Reflecting the localization results measured by a competitor's system

(2) CSV file export

3D-Office

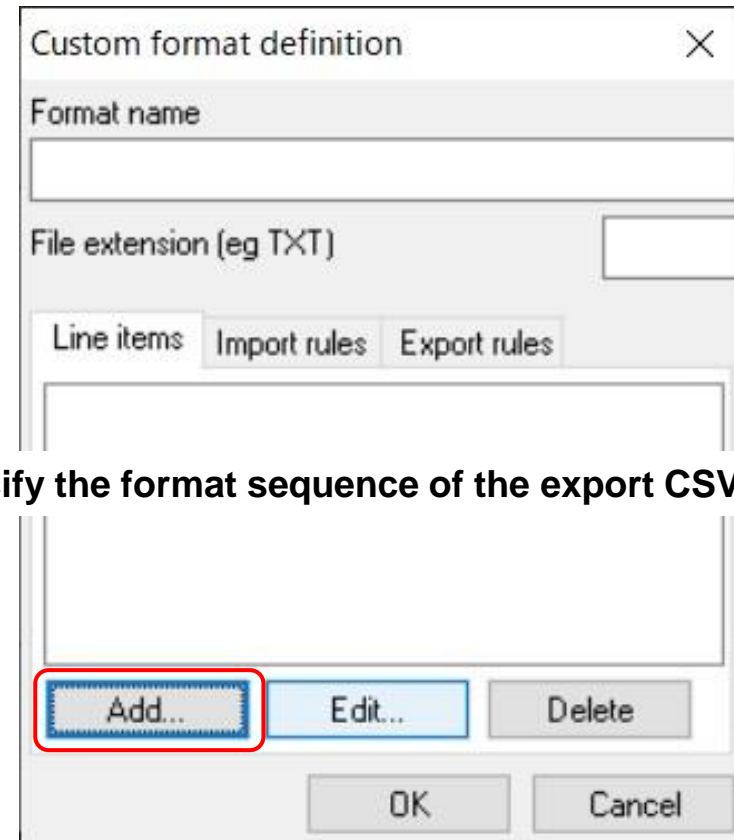
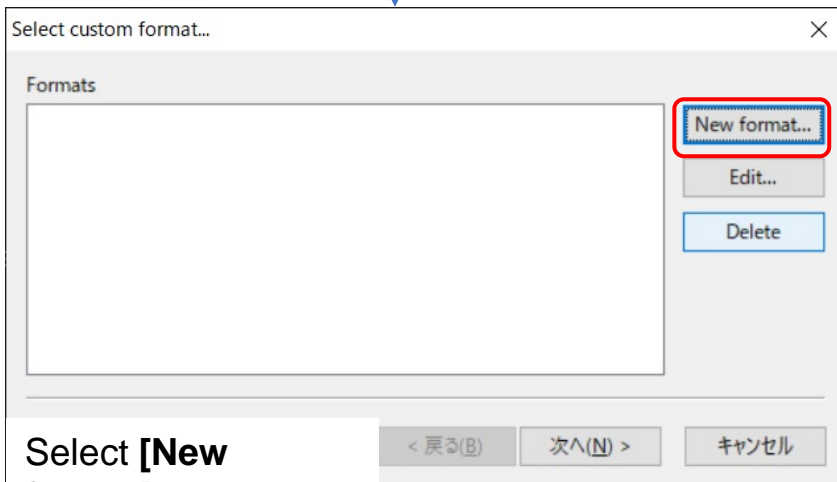
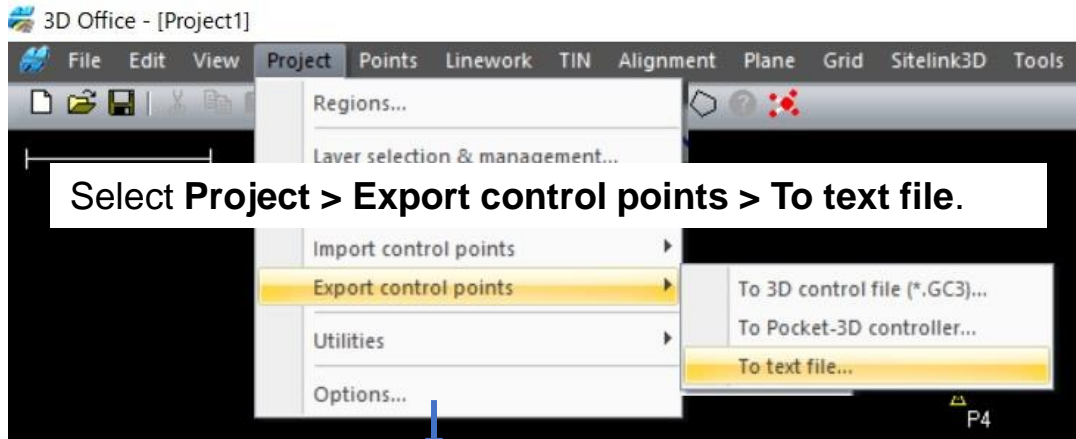

3-5-2-2. Reflecting the localization results measured by a competitor's system

(2) CSV file export

3D-Office

Specify the format sequence of the export CSV file.

* If you do it once with 3D-Office on your PC, the format you set will be saved. Therefore, from the second time onwards, you can skip making the settings.

Proceed the [Add] process in the order of [Point name] → [Point northing] → [Point Easting] → [Point elevation] → [Point WGS84 latitude] → [Point WGS84 longitude] → [Point WGS84 height].

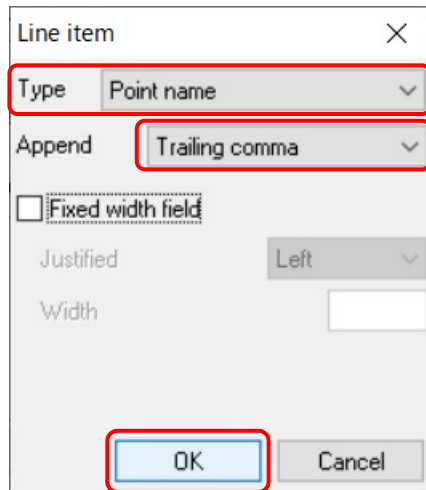

Type: Point name
Append: Select [Trailing comma] and [OK].

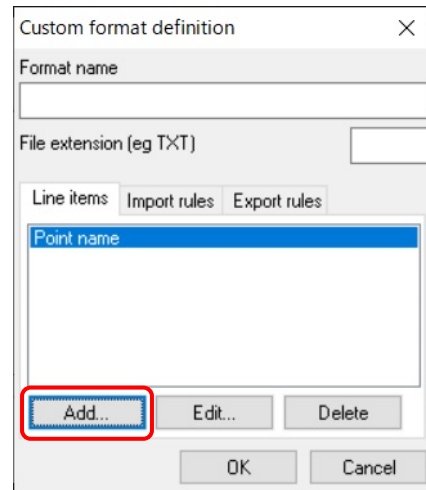

Select [Add].

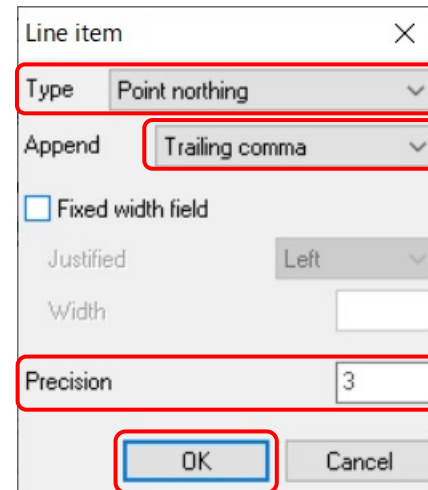

Type: Point northing
Append: Trailing comma
Precision: 3
Select it and [OK].

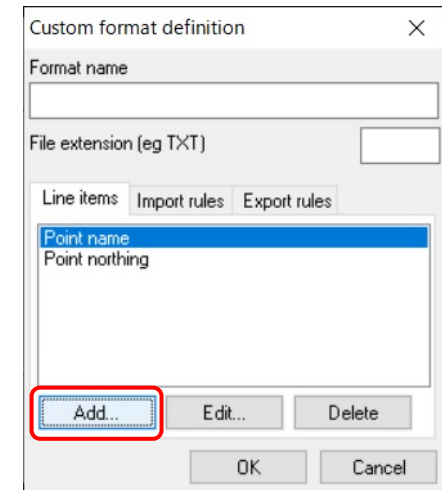

Select [Add].

3-5-2-2. Reflecting the localization results measured by a competitor's system

(2) CSV file export

3D-Office

Line item dialog box showing configuration for 'Point easting' with 'Trailing comma' append and 'Precision: 3'. The OK button is highlighted.

Type: Point earthing
Append: Trailing comma
Precision: 3
Select it and [OK].

Custom format definition dialog box showing 'Point name', 'Point northing', and 'Point easting' in the list. The Add... button is highlighted.

Select [Add].

Line item dialog box showing configuration for 'Point elevation' with 'Trailing comma' append and 'Precision: 3'. The OK button is highlighted.

Type: Point elevation
Append: Trailing comma
Precision: 3
Select it and [OK].

Custom format definition dialog box showing 'Point name', 'Point northing', 'Point easting', and 'Point elevation' in the list. The Add... button is highlighted.

Select [Add].

3-5-2-2. Reflecting the localization results measured by a competitor's system

(2) CSV file export

3D-Office

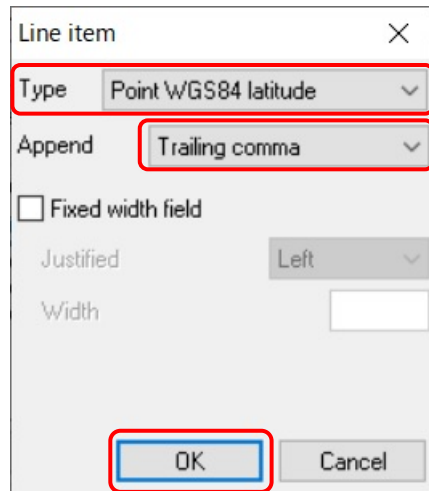

Type: Point WGS84 latitude
Append: Trailing comma
Select it and [OK].

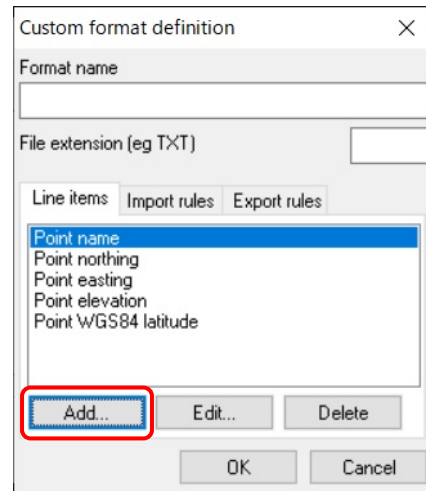

Select [Add].

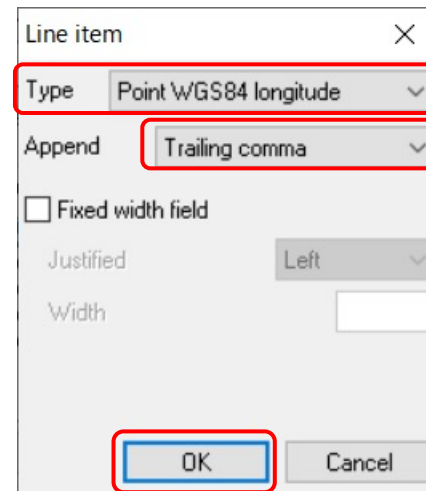

Type: Point WGS84 longitude
Append: Trailing comma
Select it and [OK].

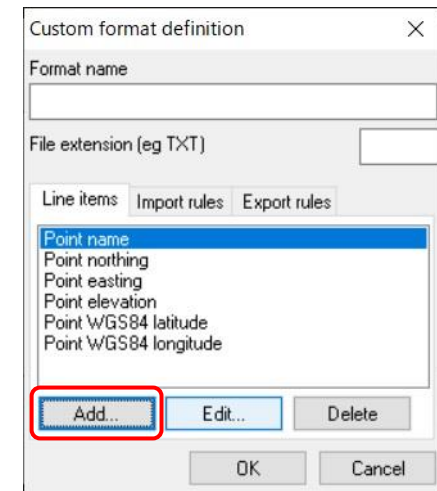

Select [Add].

3-5-2-2. Reflecting the localization results measured by a competitor's system

(2) CSV file export

3D-Office

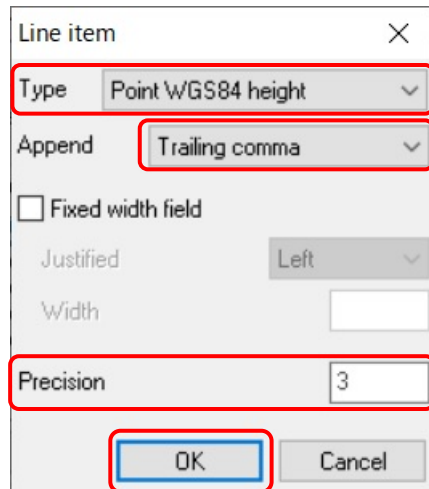

Type: Point WGS84 height
Append: Trailing comma
Select it and [OK].

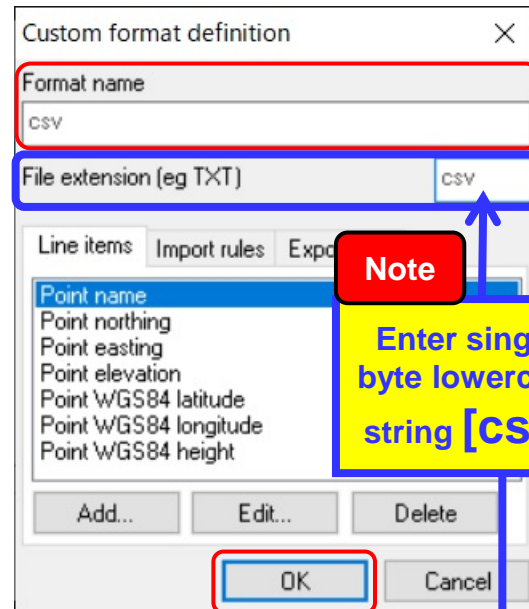

Note

Enter single-byte lowercase string [CSV].

Format name: Enter [csv].
* Other single-byte lowercase string are also accepted.

File extension(eg TXT):
Enter [csv].
* Be sure to enter a single-byte lowercase string.

After confirmation, press [OK].

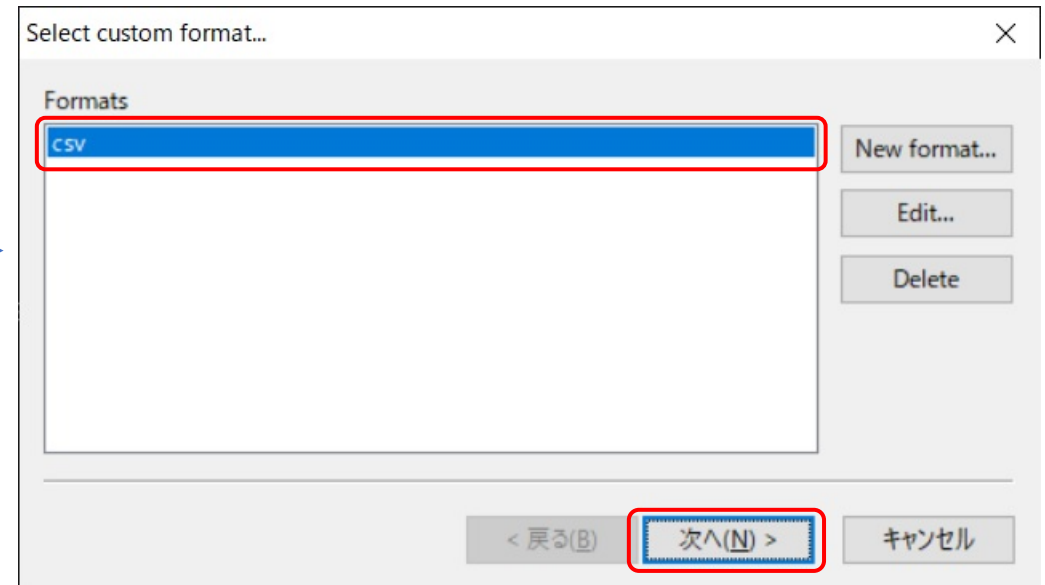

The set format is registered.

* Once registered, it will remain on the list until you [Delete] it.

Select the format to be used for the export ([csv] in this example) and press [Next (N)].

3-5-2-2. Reflecting the localization results measured by a competitor's system

(2) CSV file export

3D-Office

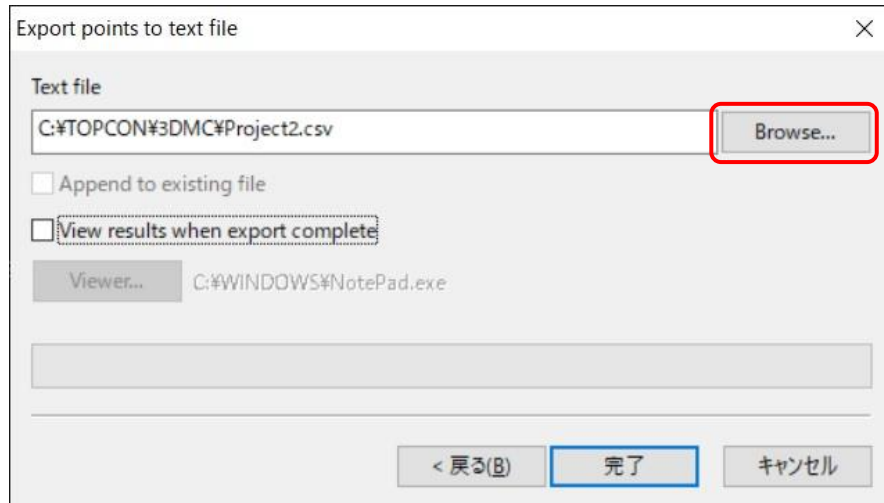

Tap **[Browse...]** and select the CSV file export destination.

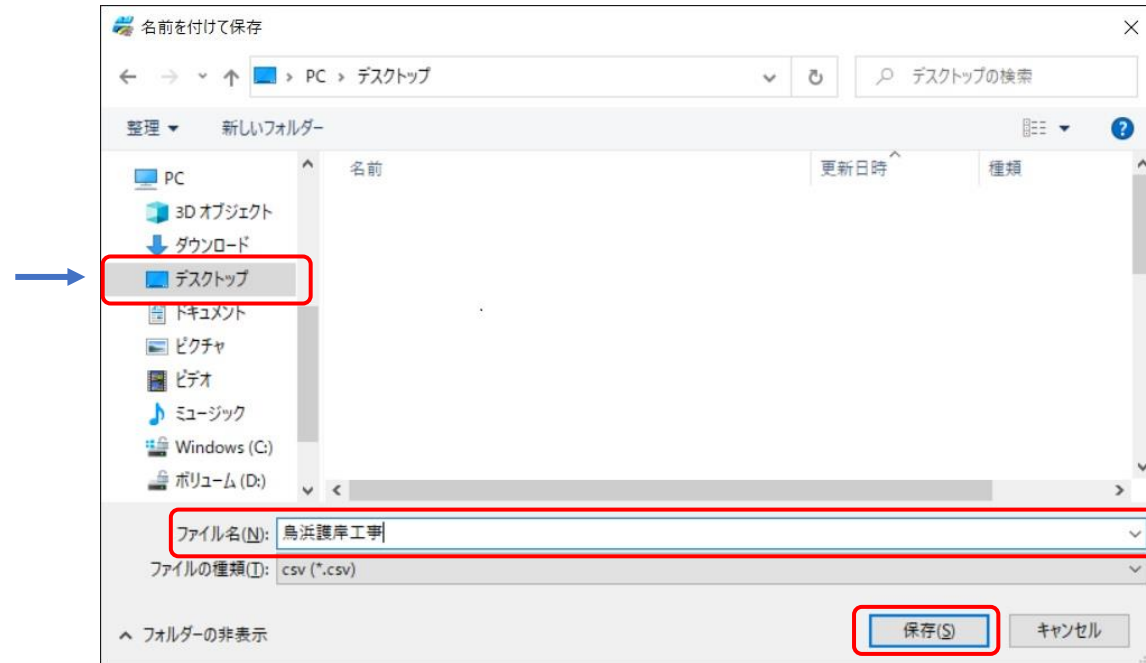

Example) Exporting the CSV file to the desktop

Select [Desktop] and, in [File name (N):], enter the file name of the file to export.

* [Toriyama Shore Protection Work] in this example.

Press **[Save]**.

3-5-2-2. Reflecting the localization results measured by a competitor's system

(2) CSV file export

3D-Office

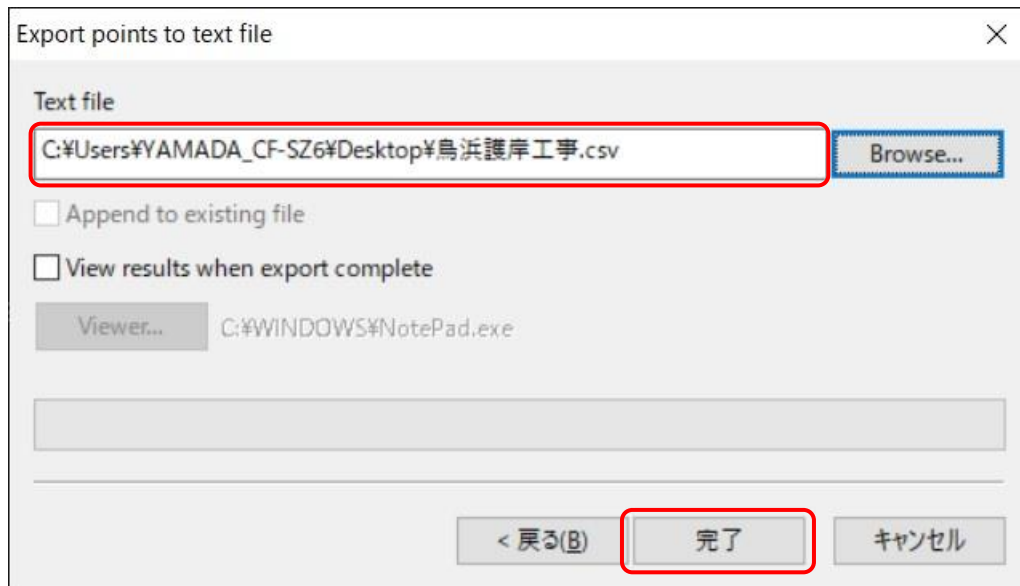

After specifying the export destination and file name, press **[Complete]**.



Example)
A CSV format file obtained by exporting X, Y, H, latitude, longitude, and ellipsoidal height data of the GC3 file obtained by measurement with the competitor's system (TOPCON)

A CSV file with the specified file name is exported to the specified export destination.

For the file format, see the next page.

3-5-2-2. Reflecting the localization results measured by a competitor's system

(2) CSV file export

3D-Office

Notes

From [SC Rover App] Ver. 000033, the **latitude and longitude** that are imported and exported from the file are in **sexagesimal notation (deg/min/s)**.

Be careful that the specification has been changed from Ver. 000033.

The latitudes and longitudes exported with a version earlier than are in decimal notation. Therefore, if a file exported with Ver. 000033 or earlier is imported with Ver. 000034 or later, **differences will arise.**

The format of the file to be imported must be as follows.

Point name	X	Y	H	Latitude * Sexagesimal	Longitude * Sexagesimal	Ellipsoidal height
1 P1	-68762.394	-17114.379	3.125	35.224817724	139.384186722	40.89
2 P11	-68781.07	-16616.376	3.134	35.224760148	139.390160158	40.87
3 P12	-68858.716	-16906.154	3.053	35.224506426	139.385012532	40.8
4 P2	-68490.502	-17241.164	3.066	35.225699250	139.383682296	40.84
5 P3	-68293.54	-17275.894	3.198	35.230338220	139.383543174	40.97
6 P4	-68105.601	-17207.49	3.228	35.230948486	139.383812814	40.99
7 P5	-67977.043	-17054.281	3.007	35.231366638	139.384418994	40.77
8 P6	-67924.949	-16758.839	3.374	35.231537494	139.385589348	41.1
9 P7	-67976.713	-16565.654	3.25	35.231370658	139.390355236	40.97
10 P8	-68105.271	-16412.445	3.558	35.230954390	139.390963306	41.28
11 P9	-68395.049	-16334.799	3.215	35.230014514	139.391273068	40.92
12 P10	-68588.234	-16386.563	2.998	35.225387280	139.391069320	40.72
13						

CSV (comma-separated) files (*.CSV) can be imported.

The data is listed as shown on the left in the format of a CSV (comma-separated values) file (*.csv).

Example) Creation with Microsoft Excel

A: Point name; B: X; C: Y; D: Z; E: Latitude; F: Longitude; G: Ellipsoidal height

Sexagesimal latitude and longitude input values (deg/min/s (DMS))

Examples) Latitude: 35°02'48.17724"

DD.MMSSSSSSSS -> 35.024817724

Longitude: 139°38'41.86722"

DDD.MMSSSSSSSS -> 139.384186722

3-5-2-2. Reflecting the localization results measured by a competitor's system

(3) Copying and pasting the CSV file to the **SC Rover App** terminal used

When migrating an import file to internal storage

Example) Connecting the PC and Motog7

Connect the PC and Motog7 with a USB cable.

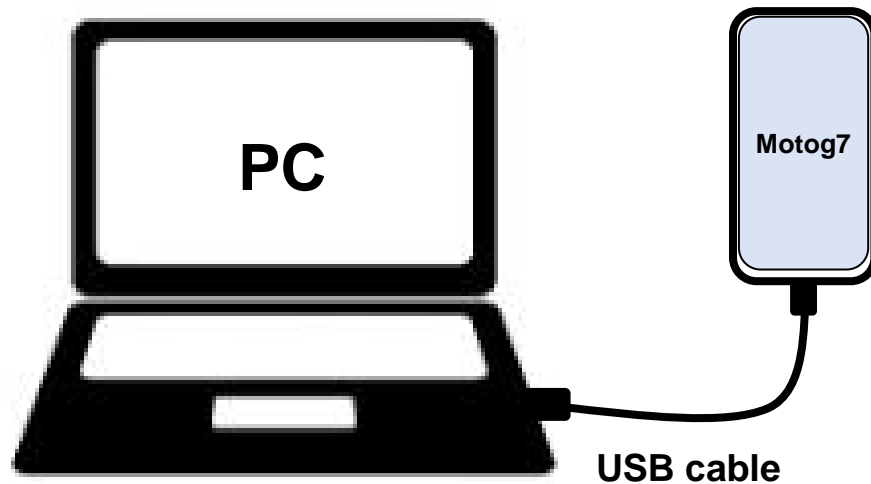

* For USB cables, the connector type differs depending on the Android terminal model.

* From [SC Rover App] Ver. 000200, file import is now enabled also from external storage (e.g. SD card, USB flash drive).

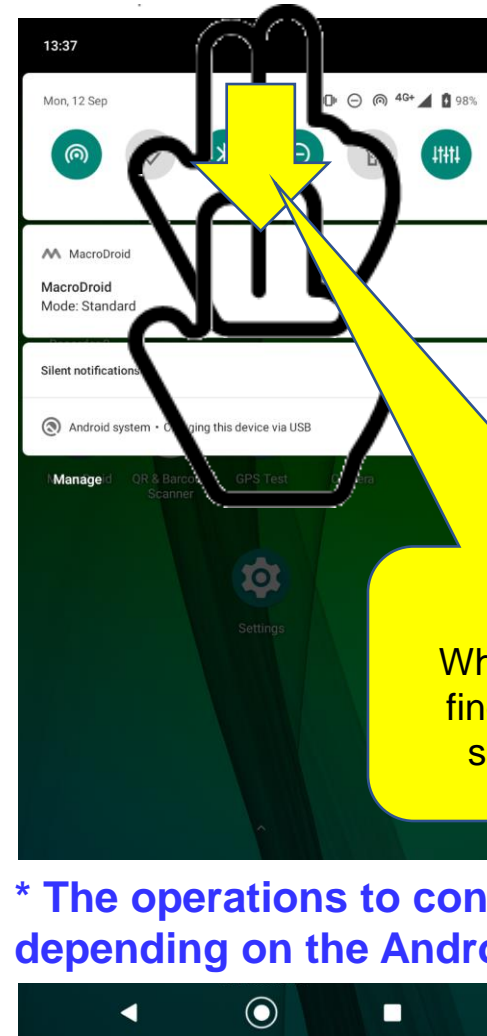

* The operations to connect it to the PC differ depending on the Android terminal used.

3-5-2-2. Reflecting the localization results measured by a competitor's system

(3) Copying and pasting the CSV file to the terminal used

SC Rover App

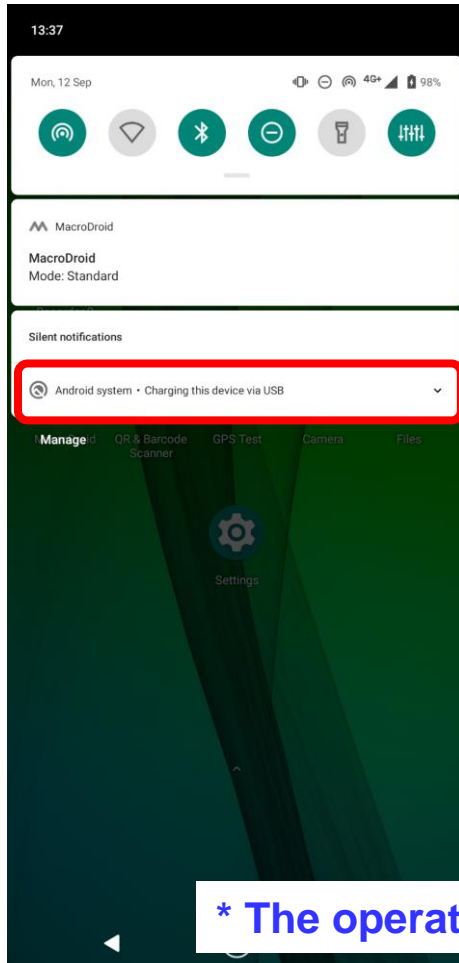

Tap [Android system - Charging this device via USB].

* If this item does not appear upon connection to the PC, check the cable and replace it, if necessary (because it may not be recognized by the USB cable you are using).

* The operations differ depending on the Android terminal used.

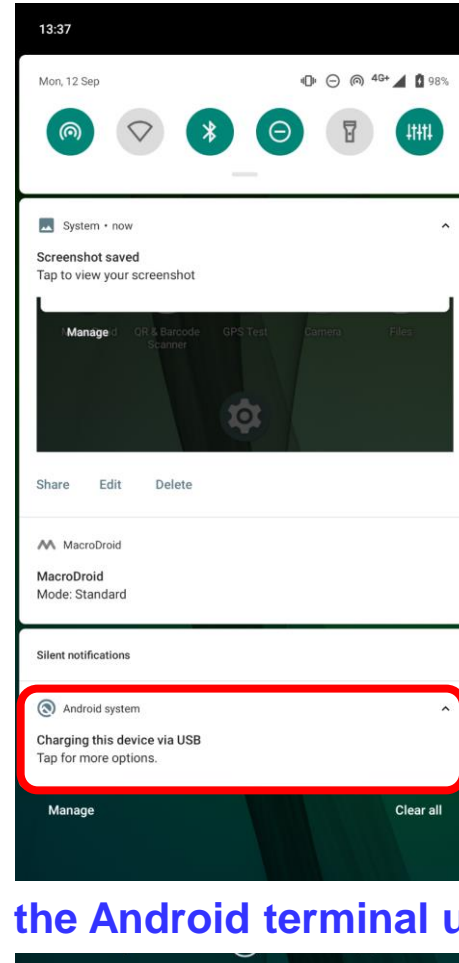

Tap [Charging this device via USB Tap for more options.].

3-5-2-2. Reflecting the localization results measured by a competitor's system

(3) Copying and pasting the CSV file to the terminal used

SC Rover App

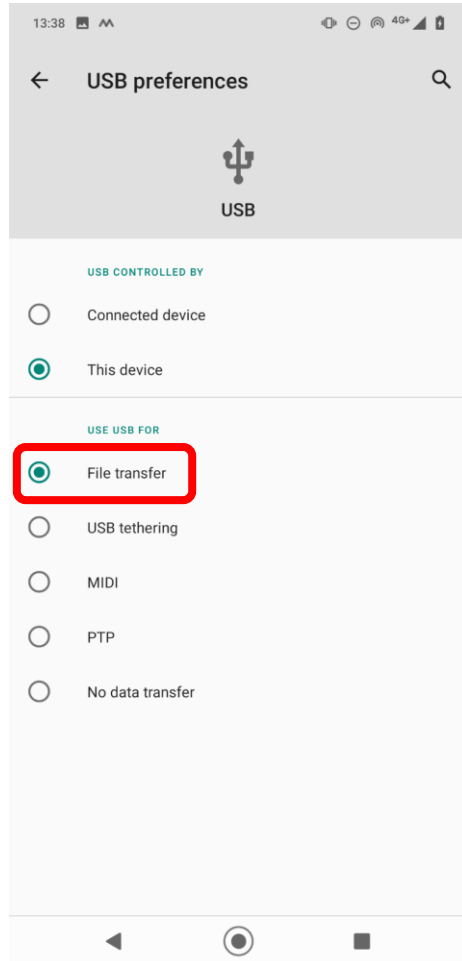

Tap **[File transfer]**.

→ The terminal will be recognized by the connected PC.

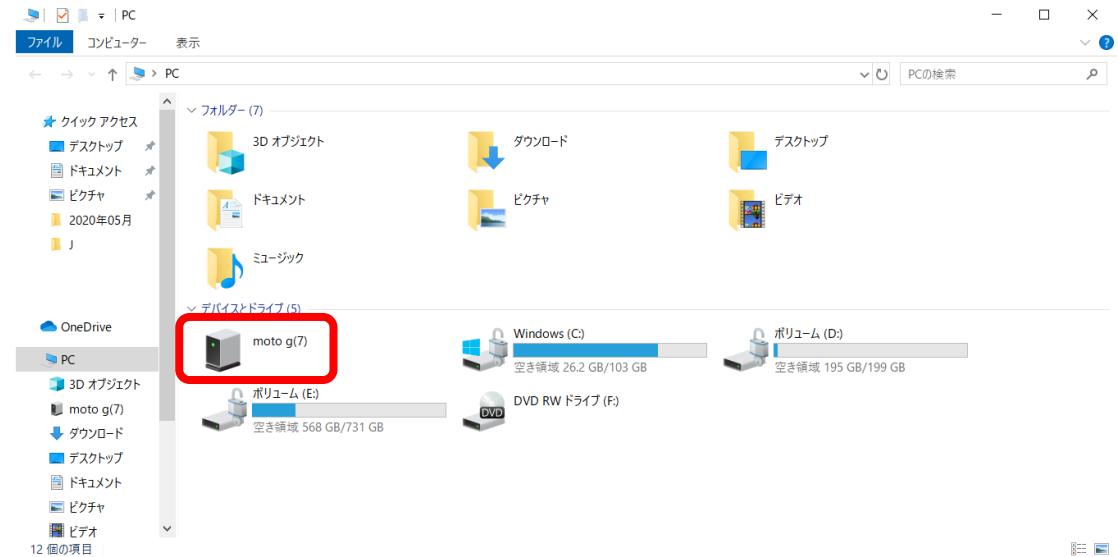

Open **[PC]** on your PC and double-click **[moto g(7)]**.

3-5-2-2. Reflecting the localization results measured by a competitor's system

(3) Copying and pasting the CSV file to the **SC Rover App** terminal used

Transfer (copy&paste) the file to the internal folder of the terminal (Motog7) to import the reference point file.

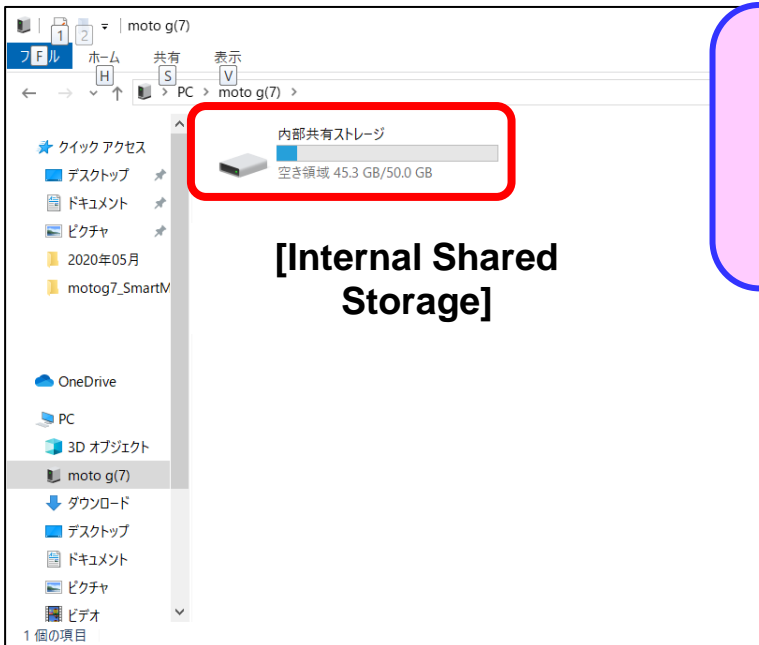

Folders for copying and pasting each file are limited.
*** For Ver. 000100 or later:**
Internal Shared Storage/Android/data/jp.akt.SC Rover App/files.

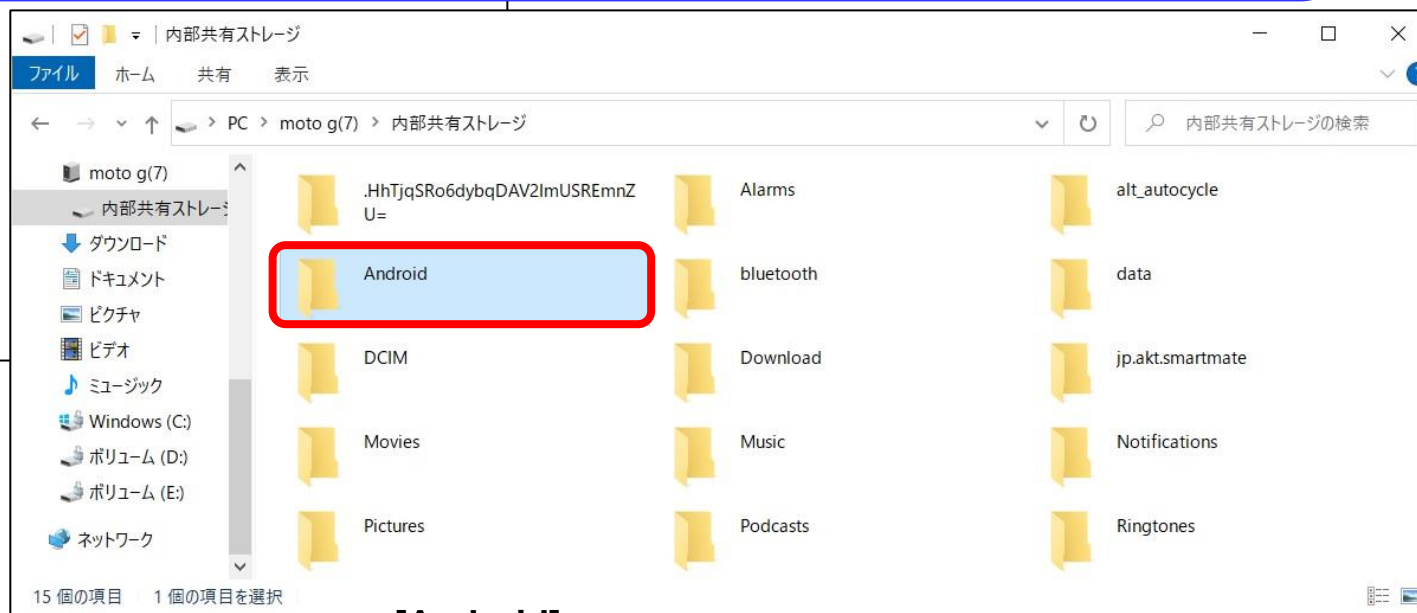

3-5-2-2. Reflecting the localization results measured by a competitor's system

(3) Copying and pasting the CSV file to the terminal used SC Rover App

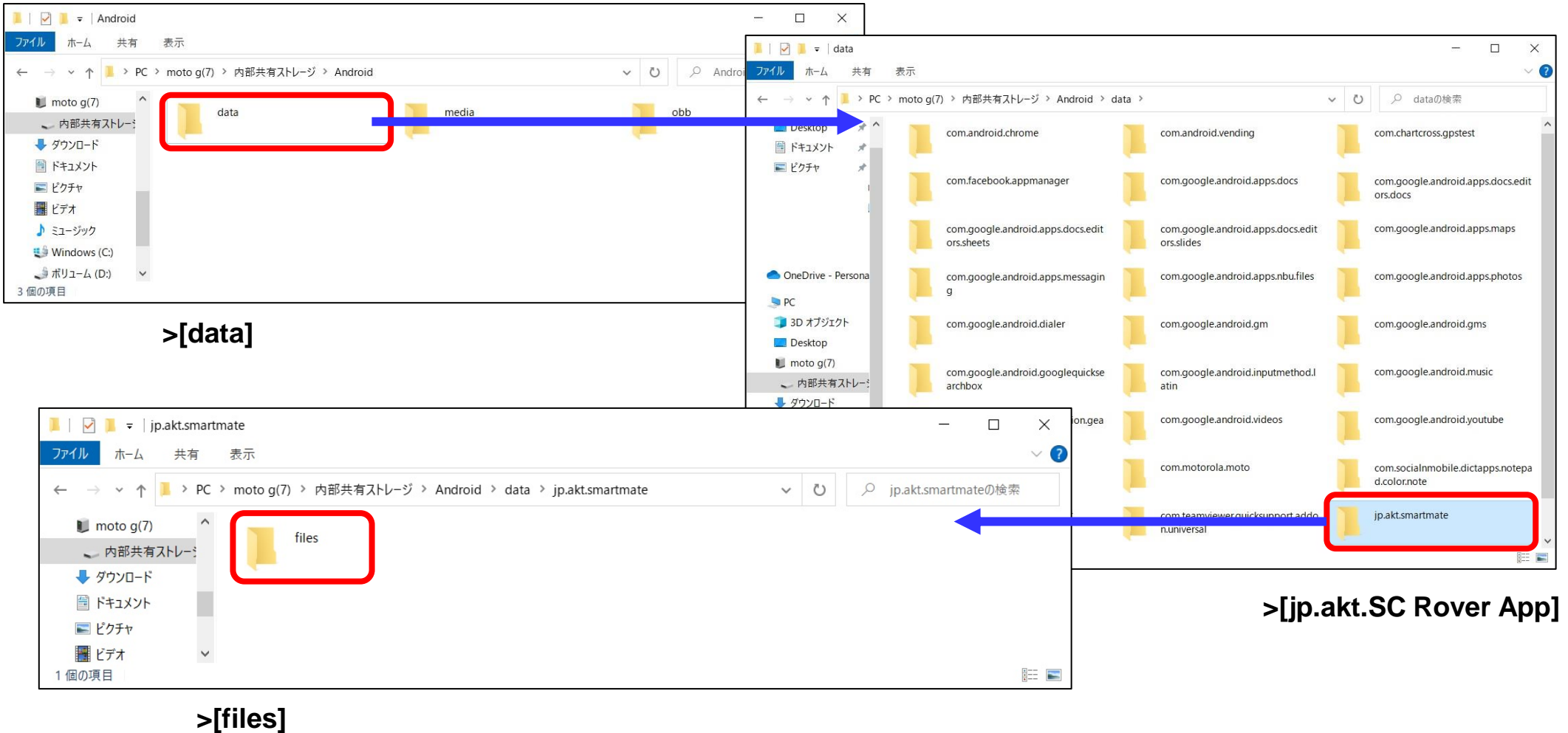

3-5-2-2. Reflecting the localization results measured by a competitor's system

(3) Copying and pasting the CSV file to the **SC Rover App** terminal used

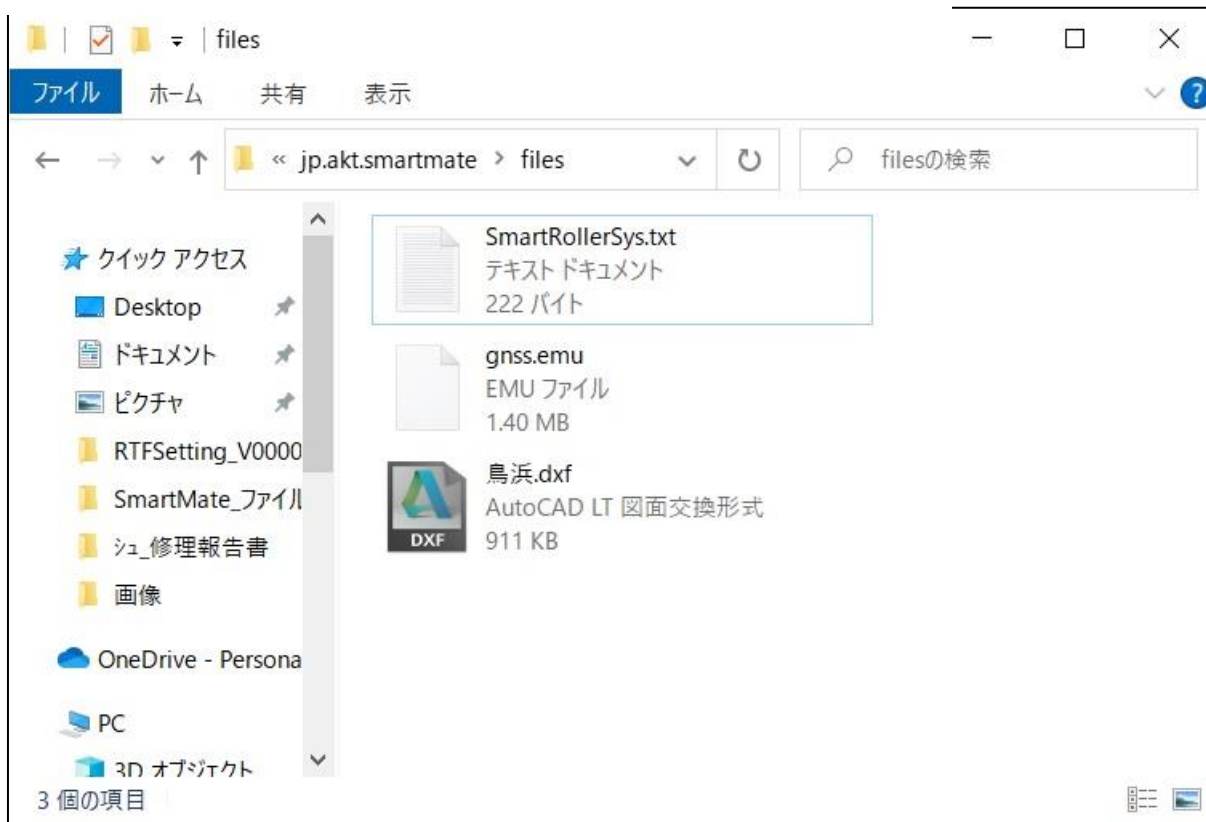

Open the **[files]** folder.



Copy the **CSV file** created with the PC.

3-5-2-2. Reflecting the localization results measured by a competitor's system

(3) Copying and pasting the CSV file to the terminal used

SC Rover App

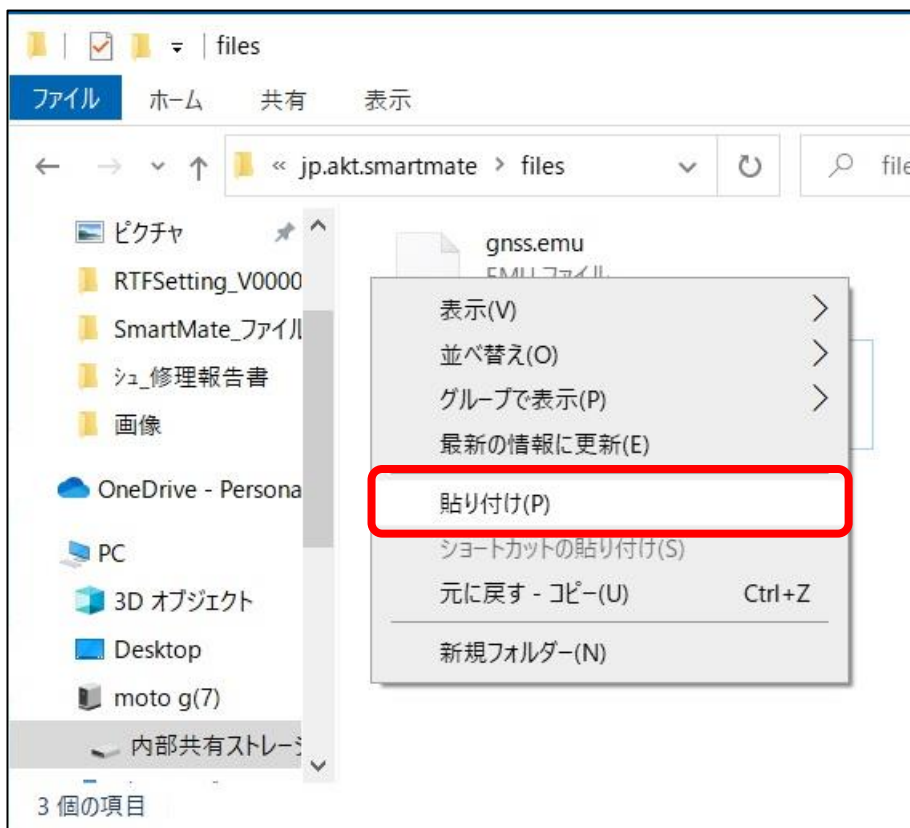

[Paste] it in the [files] folder.

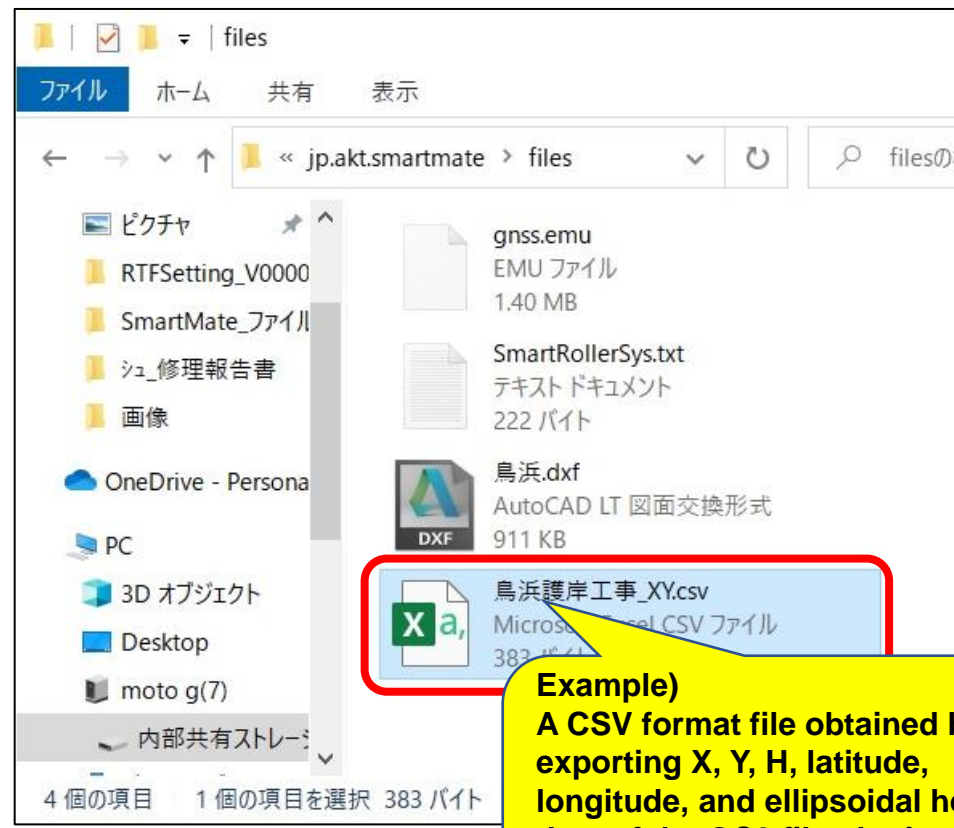



Confirm that the files have been transferred.

3-5-2-2. Reflecting the localization results measured by a competitor's system

(4) CSV file import

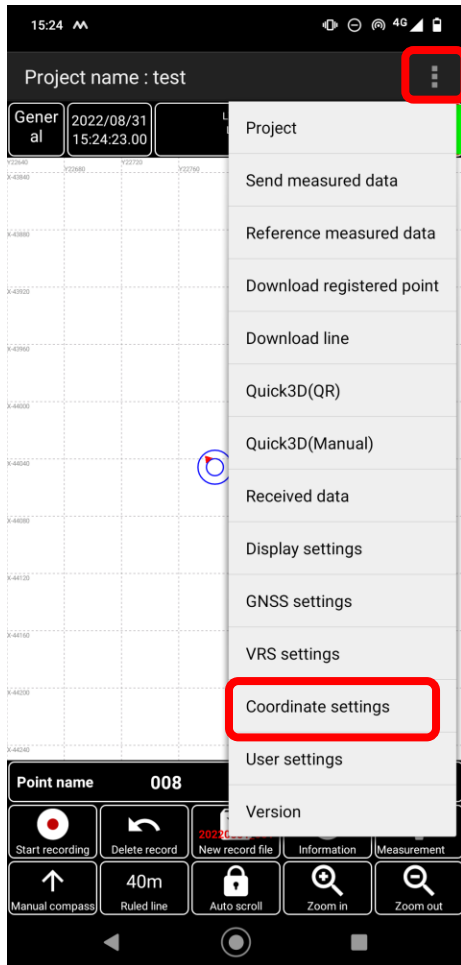
SC Rover App



Tap the menu  and then **[Coordinate settings]**.

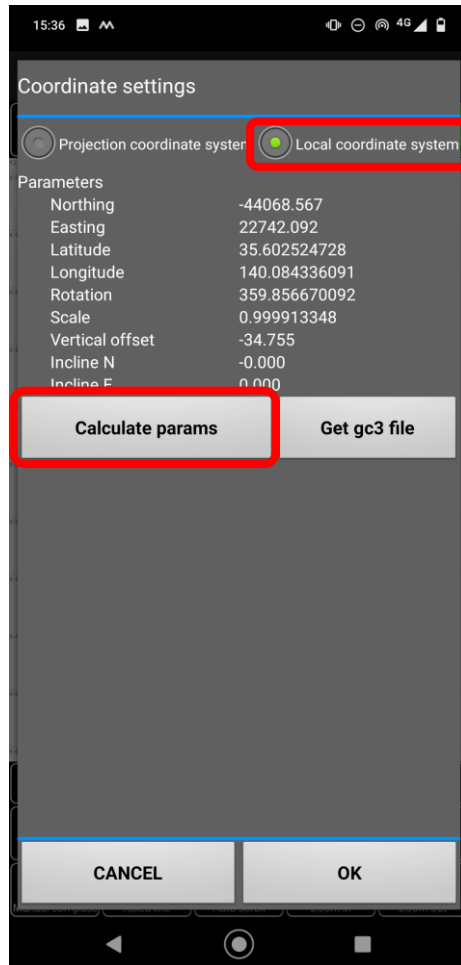

Tap **[Local coordinate system]**.

Tap **[Calculate params]**.

3-5-2-2. Reflecting the localization results measured by a competitor's system

(4) CSV file import

SC Rover App

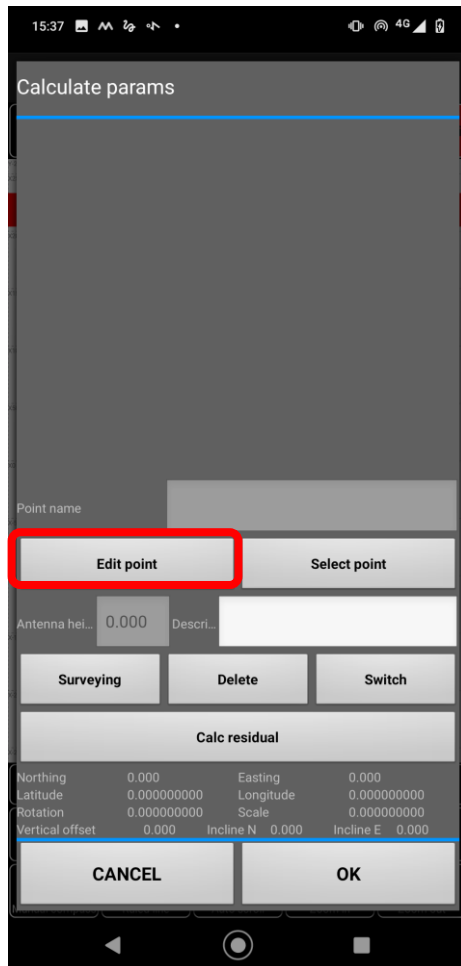

Tap [Edit point].

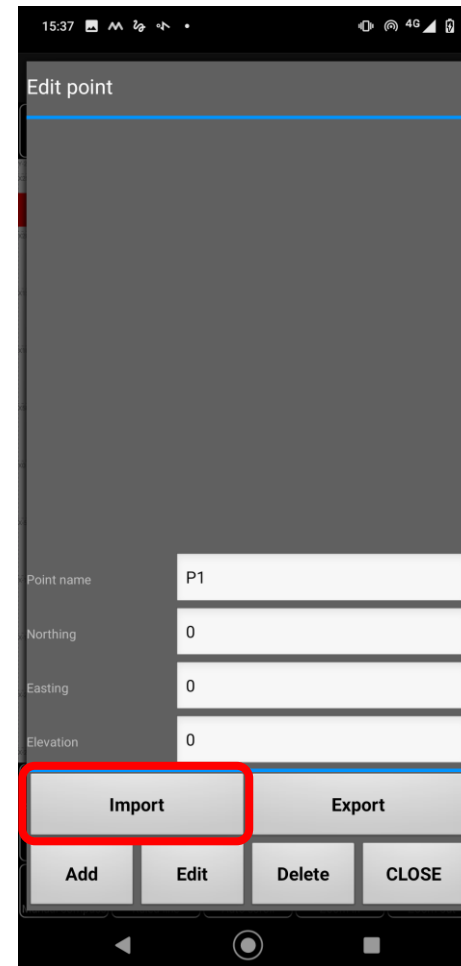

Tap [Import].

3-5-2-2. Reflecting the localization results measured by a competitor's system

(4) CSV file import

SC Rover App

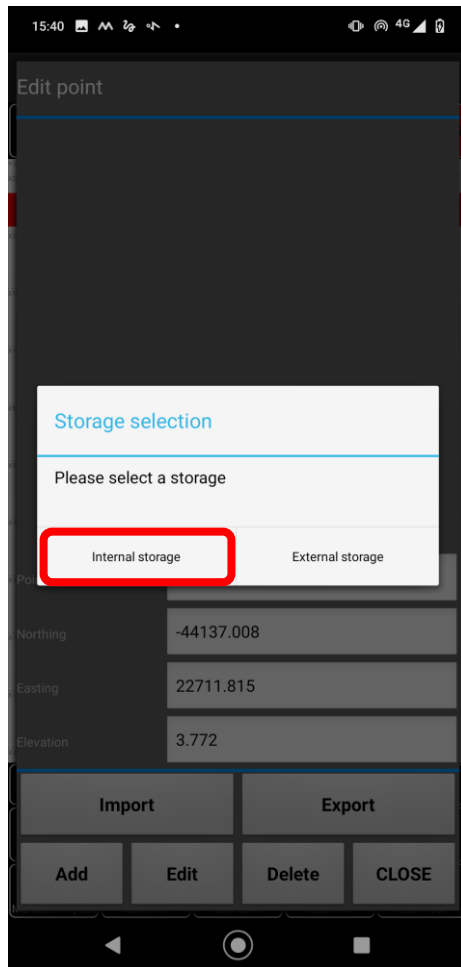

Select and tap [**Internal storage**] or [**External storage**] for the destination location to which to import the file.

* **Internal storage**
Specified importing destination folder

Internal Shared Storage/Android/data/ip.akt.SC Rover App/files

* **External storage**
SD card, USB flash drive, etc.

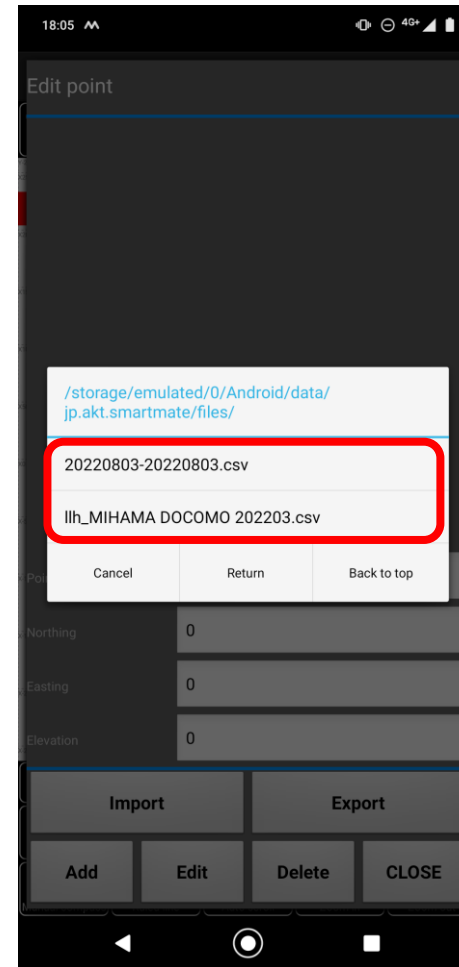

The names of the CSV files pre-migrated to the specified folder are listed. Select and tap the file to import.

3-5-2-2. Reflecting the localization results measured by a competitor's system

(4) CSV file import

SC Rover App

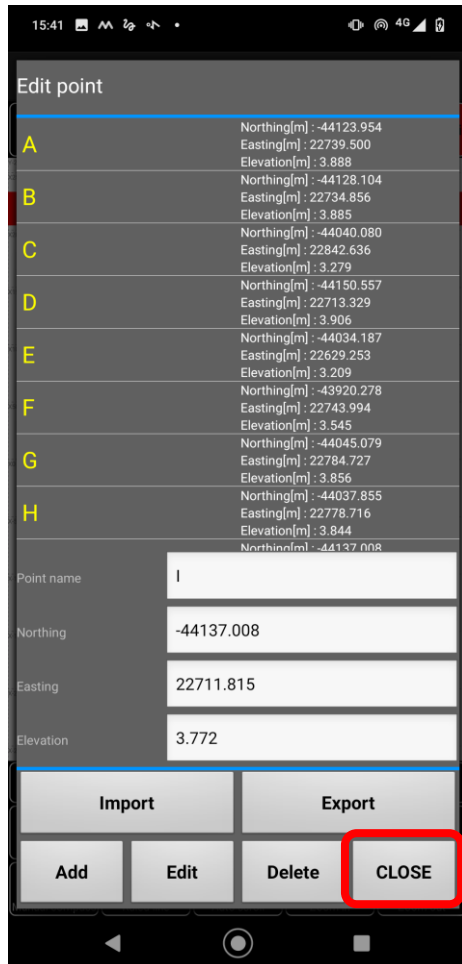

The reference point in the file is imported.

After confirmation, tap **[CLOSE]**.

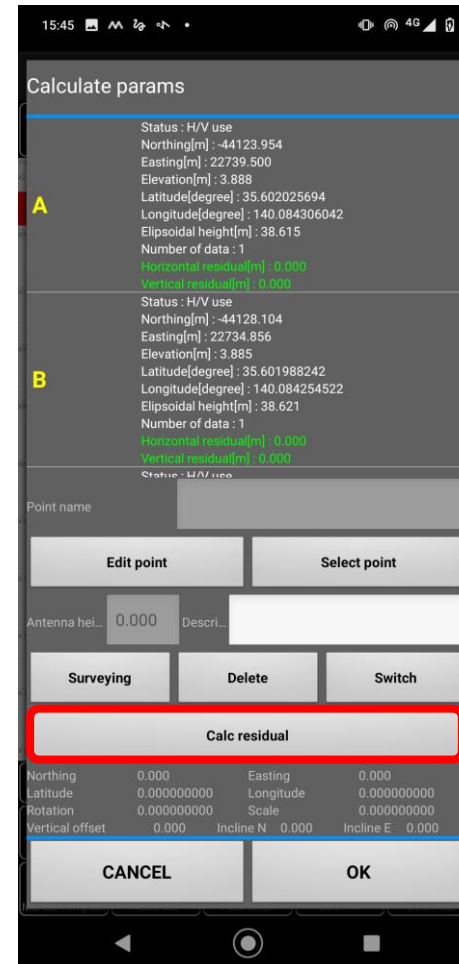

Then perform **[Calc residual]**.

Residual calculations and control point registration cannot be performed unless an Internet communication environment is available.

3-5-2-2. Reflecting the localization results measured by a competitor's system

(4) CSV file import

SC Rover App

When reflecting the results of localization with the competitor's system and registering the residual calculations and control points

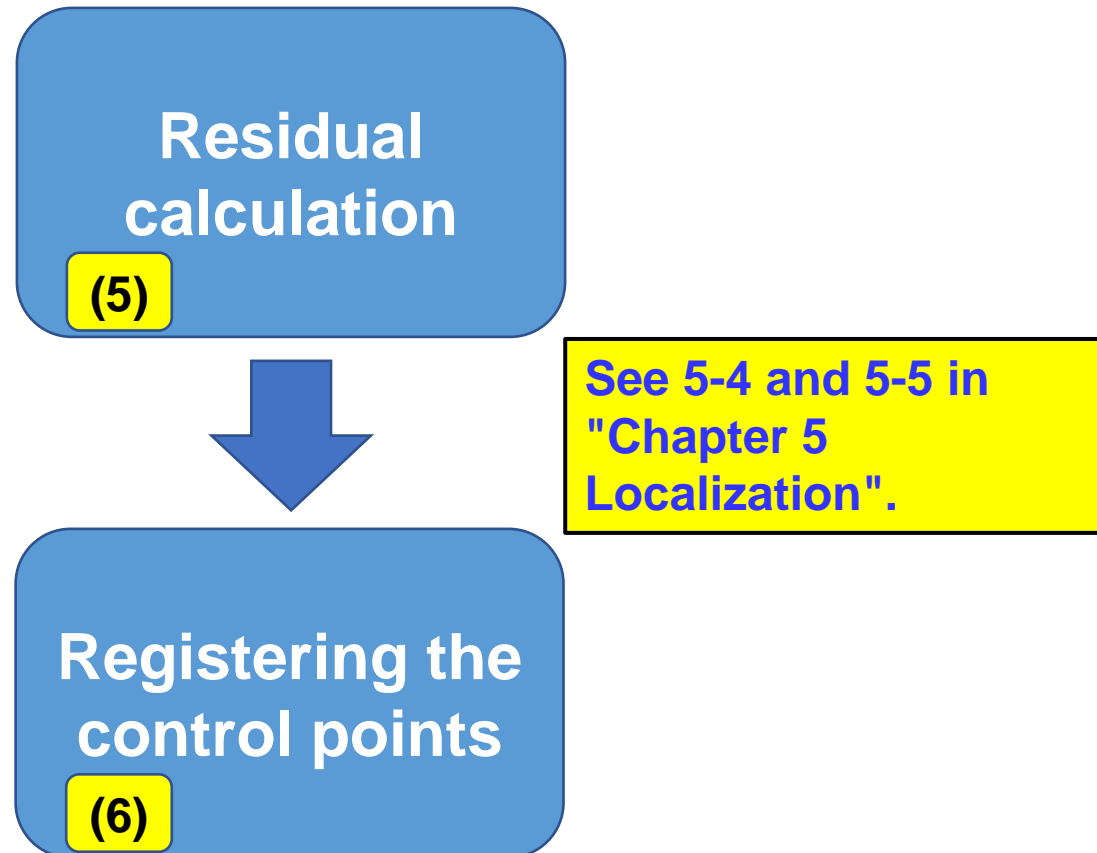

3-5-2-3. Exporting the localization file

This function can export the measured latitude, longitude, and ellipsoidal height, as well as the reference point (X, Y, H) registered in the terminal, as a CSV file.

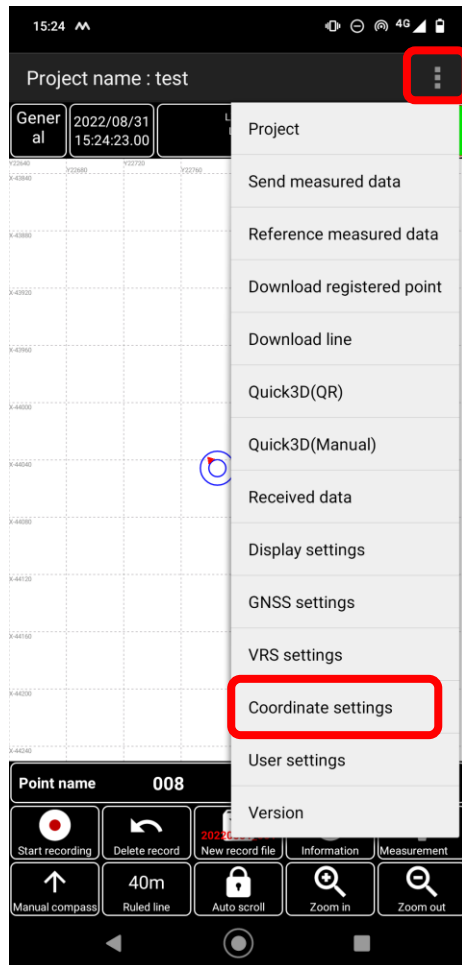

Tap the menu  and then **[Coordinate settings]**.

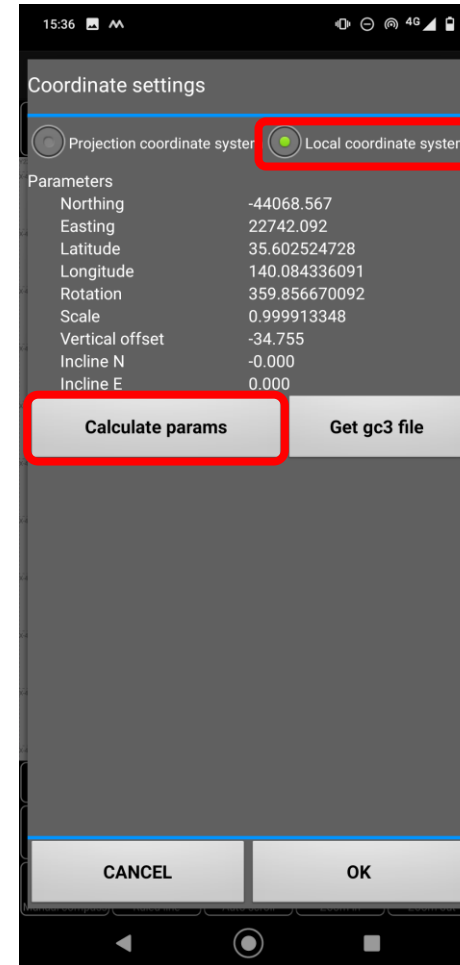

Tap **[Local coordinate system]**.

Tap **[Calculate params]**.

3-5-2-3. Exporting the localization file

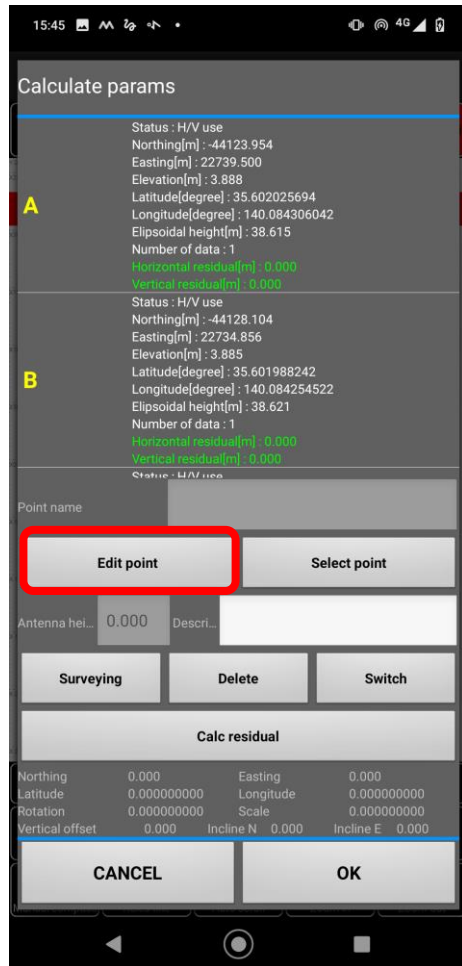

Tap [Edit point].

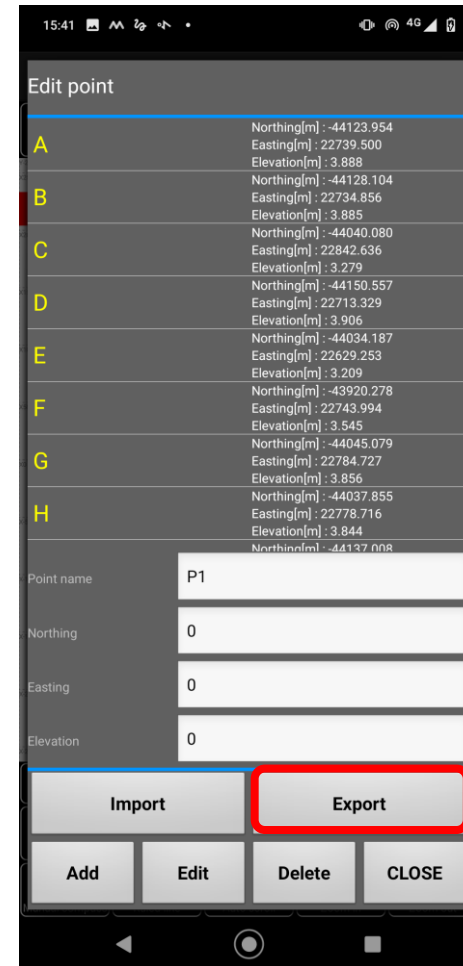

To export the reference point in the terminal to a file, tap [Export].

3-5-2-3. Exporting the localization file

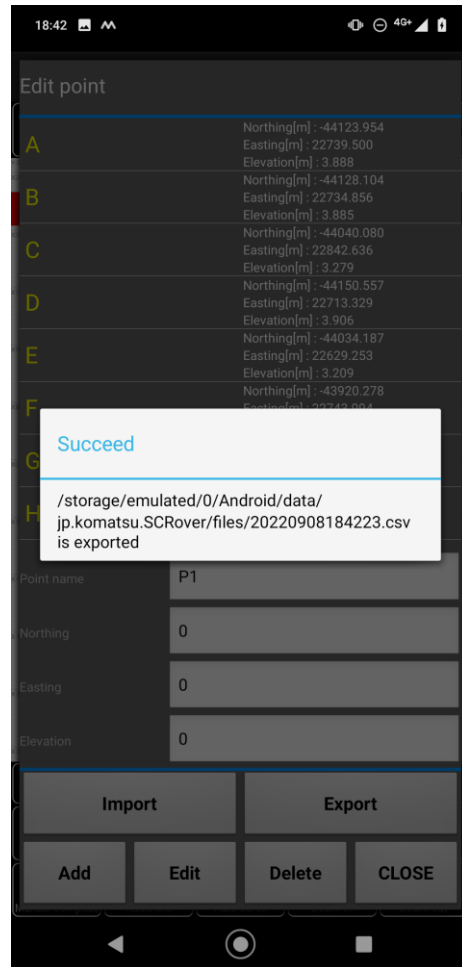

Folder in the terminal:Data will be exported to **Internal Shared Storage/Android/data/ip.akt.SC Rover App/files** folder.

* The exported file will be named [yyyymmddhhmmss.csv] (date and time of export).

* **The export destination folder is unchangeable.**

Connect the terminal and PC. Then, transfer to the PC, the files exported in the terminal.

For connection between the PC and terminal, see **3-5-2-2, "(3) Copying and pasting the CSV file to the terminal"**.

3-5-2-3. Exporting the localization file

Exported file format (e.g. file resulting from localization)

Notes

From [SC Rover App] Ver. 000033, the **latitude and longitude** that are imported and exported from the file are in **sexagesimal notation (deg/min/s)**.

Be careful that the specification has been changed from Ver. 000033.

The latitudes and longitudes exported with a version earlier than 000033 or earlier are in decimal notation (deg).

The file format exported is as follows.

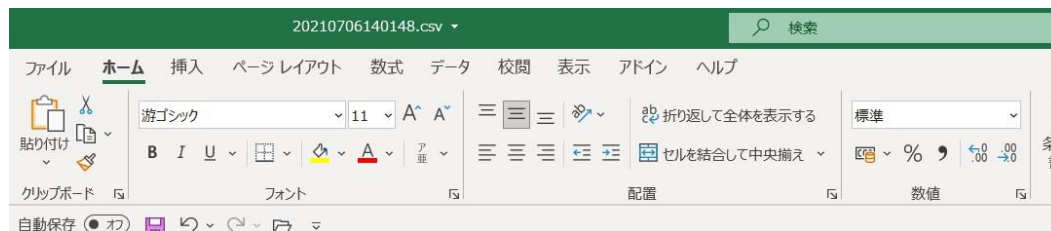

Point name	X	Y	H	Latitude * Sexagesimal	Longitude * Sexagesimal	Ellipsoidal height
基準点名	X	Y	Z	緯度[60進]	経度[60進]	高さ
P1	-68762.394	-17114.379	3.125	35.22481772	139.3841867	40.889
P10	-68588.234	-16386.563	2.998	35.22538728	139.3910693	40.72
P11	-68781.07	-16616.376	3.134	35.22476015	139.3901602	40.87
P12	-68858.716	-16906.154	3.053	35.22450643	139.3850125	40.8
P2	-68490.502	-17241.164	3.066	35.22569925	139.3836823	40.84
P3	-68293.54	-17275.894	3.198	35.23033822	139.3835432	40.97
P4	-68105.601	-17207.49	3.228	35.23094849	139.3838128	40.99
P5	-67977.043	-17054.281	3.007	35.23136664	139.384419	40.769
P6	-67924.949	-16758.839	3.374	35.23153749	139.3855893	41.1
P7	-67976.713	-16565.654	3.25	35.23137066	139.3903552	40.97
P8	-68105.271	-16412.445	3.558	35.23095439	139.3909633	41.279
P9	-68395.049	-16334.799	3.215	35.23001451	139.3912731	40.92

The data is listed as shown on the left in the CSV (comma-separated values) file (*.csv) format.

Example) Export with Microsoft Excel

A: Point name; B: X; C: Y; D: H; E: Latitude; F: Longitude; G: Ellipsoidal height

Sexagesimal notation of latitude and longitude

Examples)

Latitude: 35°22'48.17724"

DD.MMSSSSSSSS -> 35.224817724

Longitude: 139°38'41.86722"

DDD.MMSSSSSSSS -> 139.384186722

- If measurement is made at a registered point, data will be output with the latitude, longitude, and ellipsoidal height added.
- If no measurement is made at the registered point, data will be output with the latitude, longitude, and ellipsoidal height fields blank (null).

File import succeeds without cell row 1.

If no localization has been done, E: Latitude; F: Longitude; or G: Ellipsoidal is not output.

3-6. Display settings

3-6-1. Importing a DXF file

A file imported on the terminal can be displayed. The DXF file supported version is R12. Note that some DXF files may not be imported or displayed.

* Copy the desired DXF file to import to the specified folder on the terminal. * See 3-5-2-2, "(3) Copying and pasting the CSV file to the terminal".

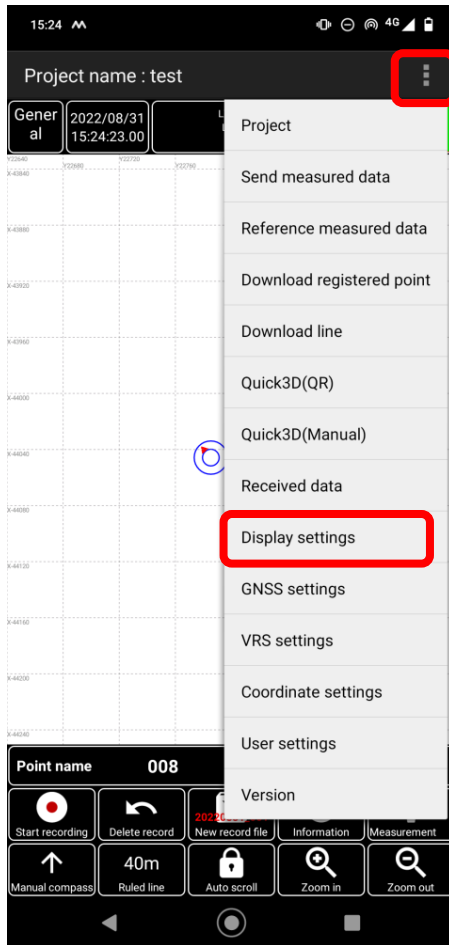

Tap the menu  and then [Display settings].

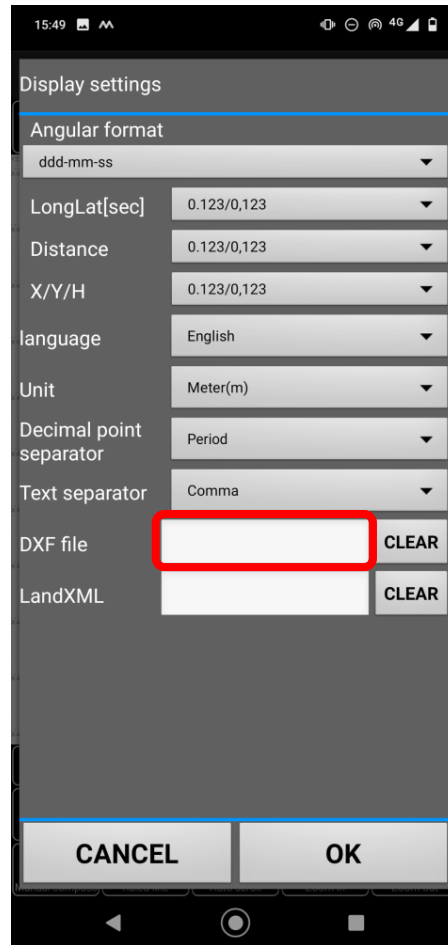

Tap in the [DXF file] box.

3-6-1. Importing a DXF file

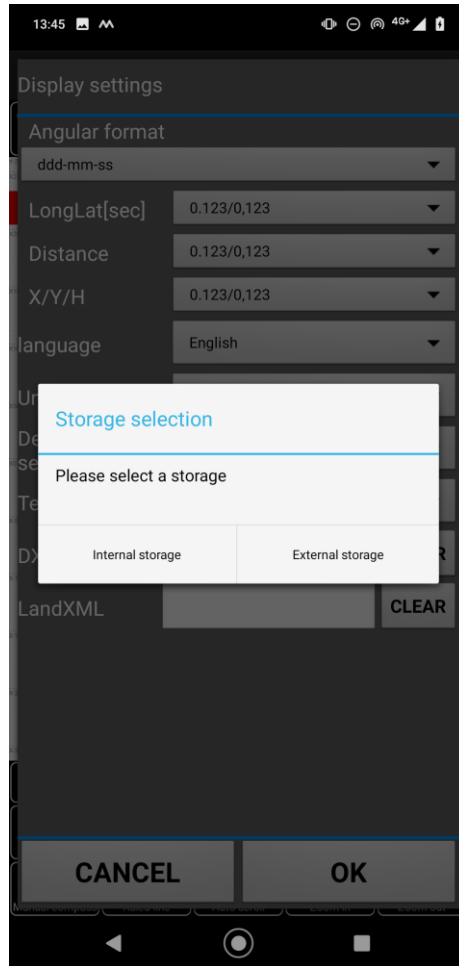

Select and tap [**Internal storage**] or [**External storage**] for the destination location to which to import the file.

* Internal storage
Specified importing destination folder
[Internal Shared Storage/Android /data/ip.akt.SC Rover App/files](#)

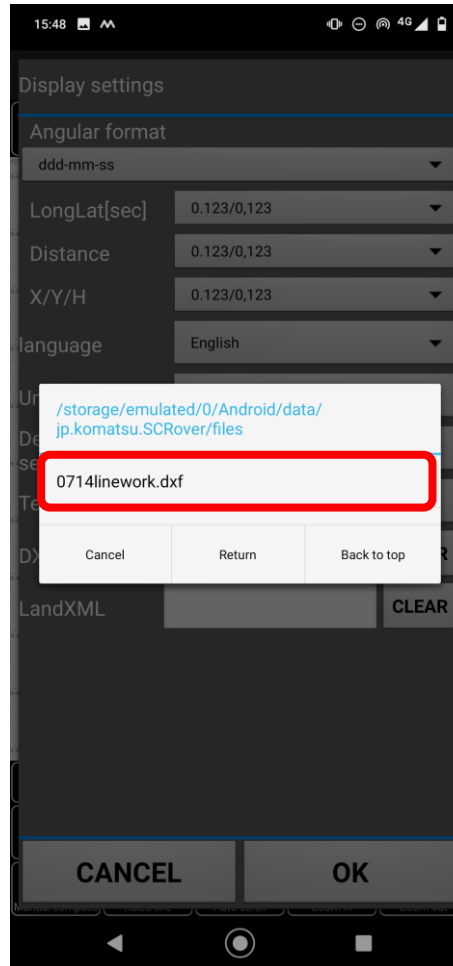

The name of the dxf file pre-migrated to the specified folder is shown. Select and tap the file to import.

3-6-1. Importing a DXF file

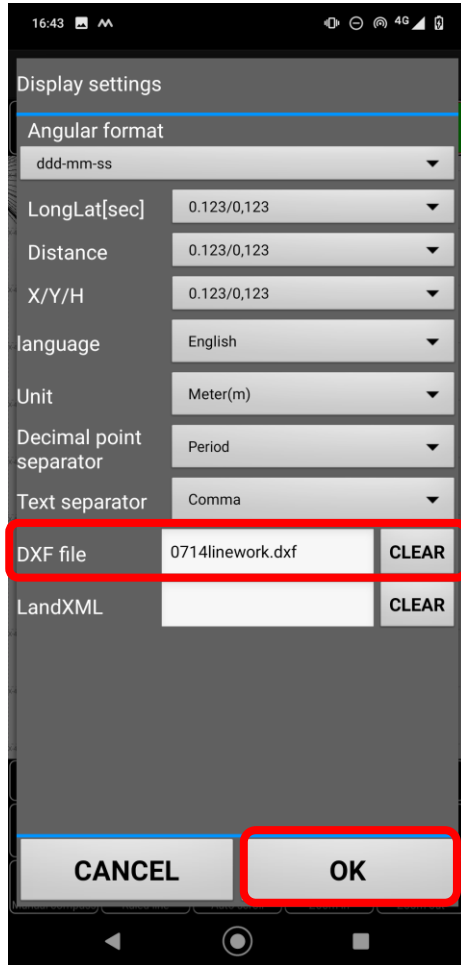

* **Hiding the DXF file**
Tapping [CLEAR] blanks the inside of the box.
The DXF file will be hidden by tapping [OK] in the blanked field.

* [LandXML] can also be shown at the same time.

Tap [OK].

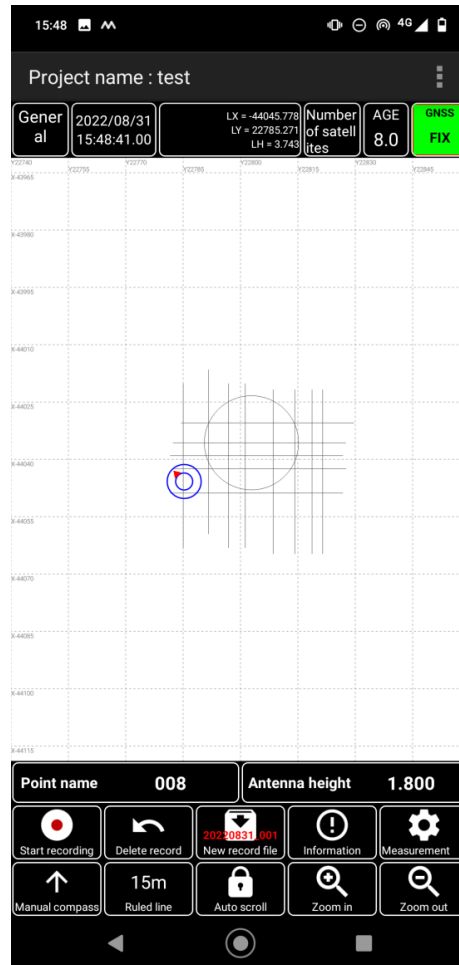

If the DXF file you tried to import has been successfully imported, it will be displayed on the screen during measurement.

* Whether display or measurement is enabled may vary depending on the file size and the specifications and usage conditions of the terminal used.

3-6-2. Importing a LandXML file

Data display and measurement are enabled using the LandXML file imported during measurement.

Note that It may fail to import or display some LandXML files.

* Copy the desired LandXML file to import to the specified folder on the terminal.

* See 3-5-2-2, "(3) Copying and pasting the CSV file to the terminal".

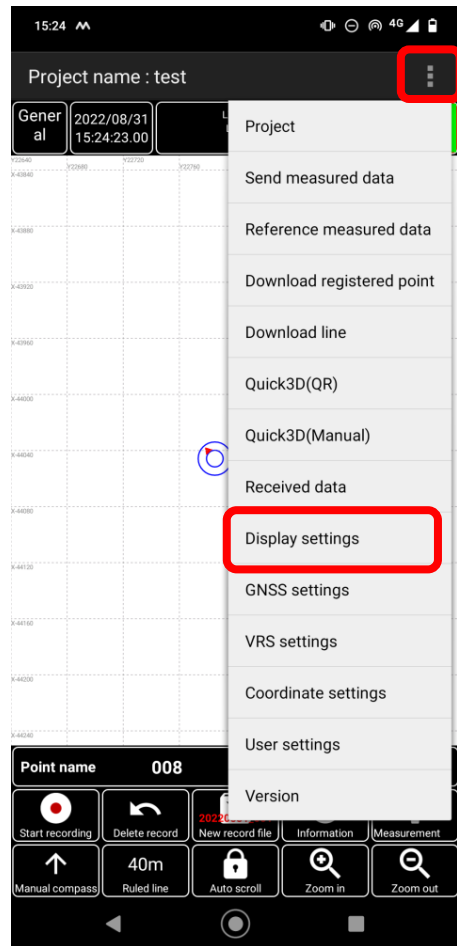

Tap the menu  and then **[Display settings]**.

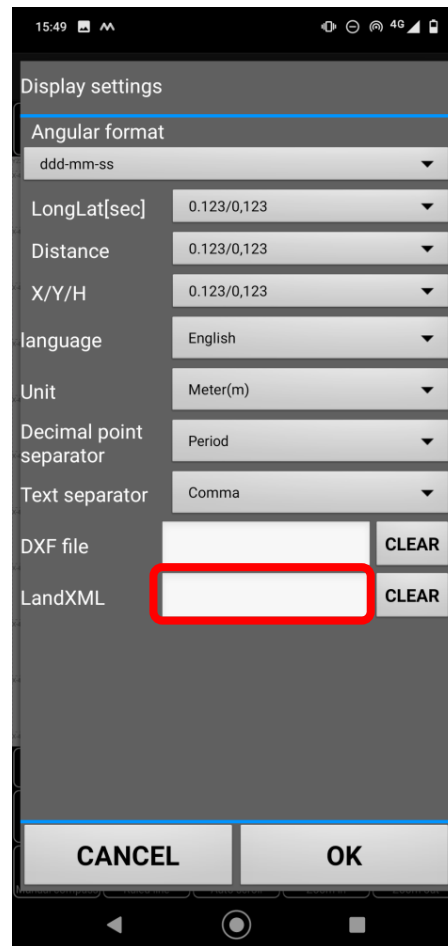

Tap in the **[LandXML]** box.

3-6-2. Importing a LandXML file

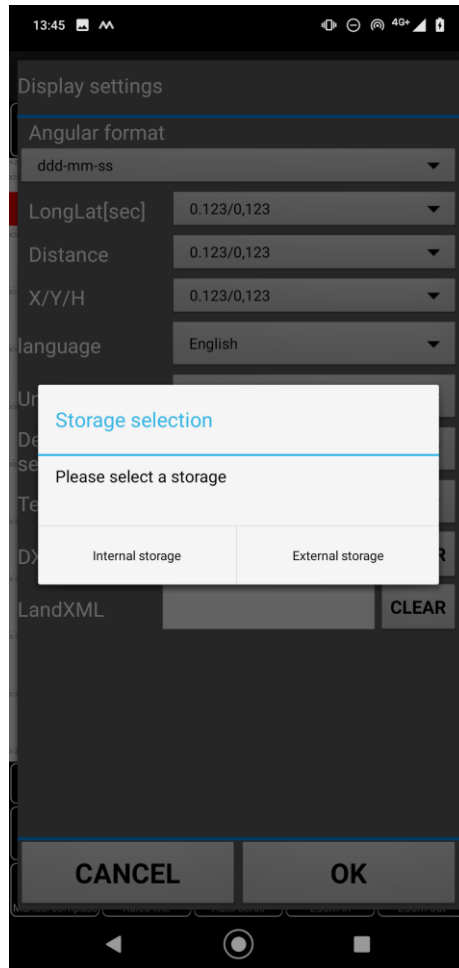

Select and tap [**Internal storage**] or [**External storage**] for the destination location to which to import the file.

* Internal storage
Specified importing destination folder
[Internal Shared Storage/Android /data/ip.akt.SC Rover App/files](#)

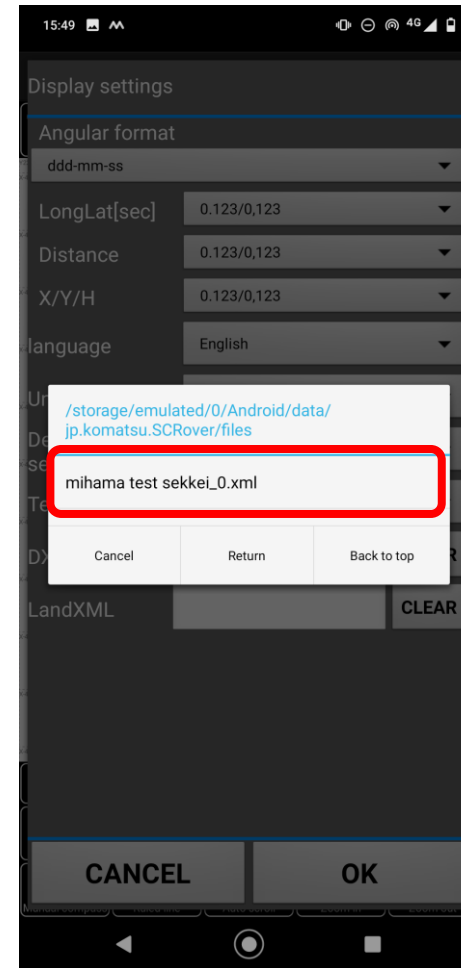

The name of the LandXML file pre-migrated to the specified folder is shown. Select and tap the file to import.

3-6-2. Importing a LandXML file

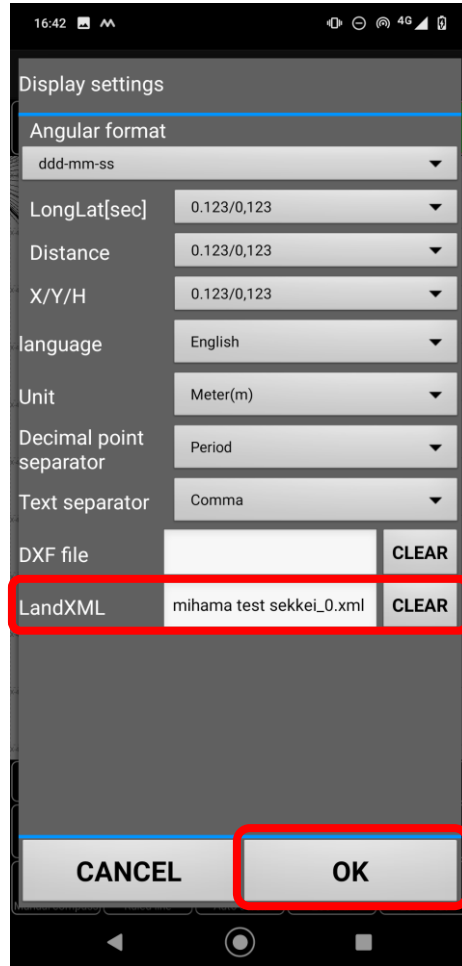

* **Hiding the DXF file**
Tapping [CLEAR] blanks the inside of the box.
The LandXML file will be hidden by tapping [OK] in the blanked field.

* [DXF] can also be shown at the same time.

Tap [OK].

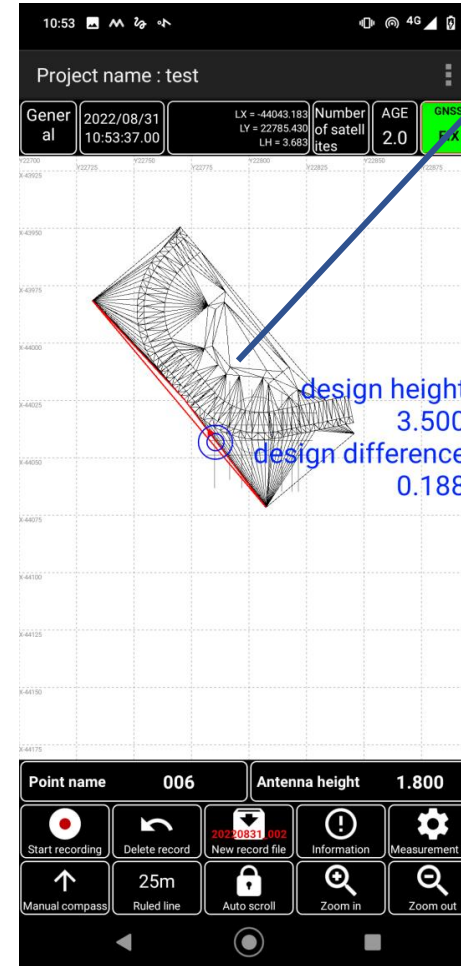

The DXF file must be a drawing with local X,Y coordinates at a scale of 1:1.

If the LandXML file you tried to import has been successfully imported, it will be displayed on the screen during measurement.

* Whether display or measurement is enabled may vary depending on the file size and the specifications and usage conditions of the terminal used.

3-6-3. Setting the language, units, decimal point notation, and separator

You can set the language, units, decimal point notation, and separator.

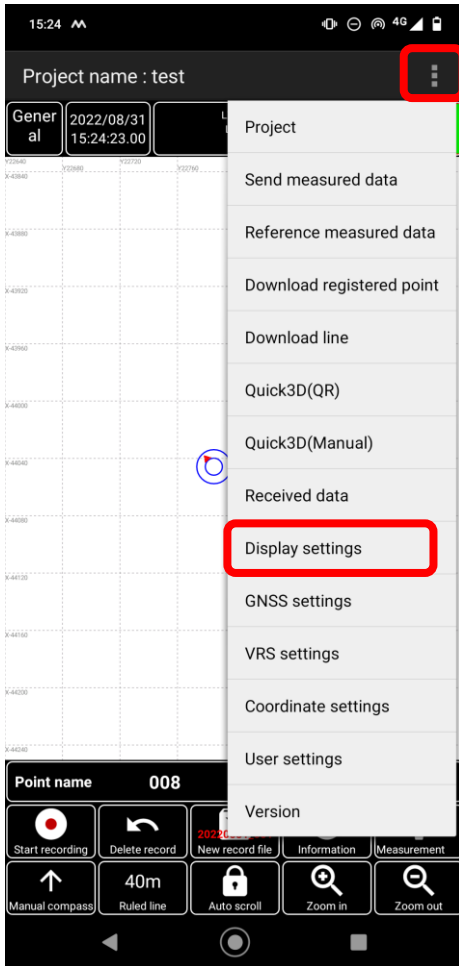

Tap the menu  and then **[Display settings]**.

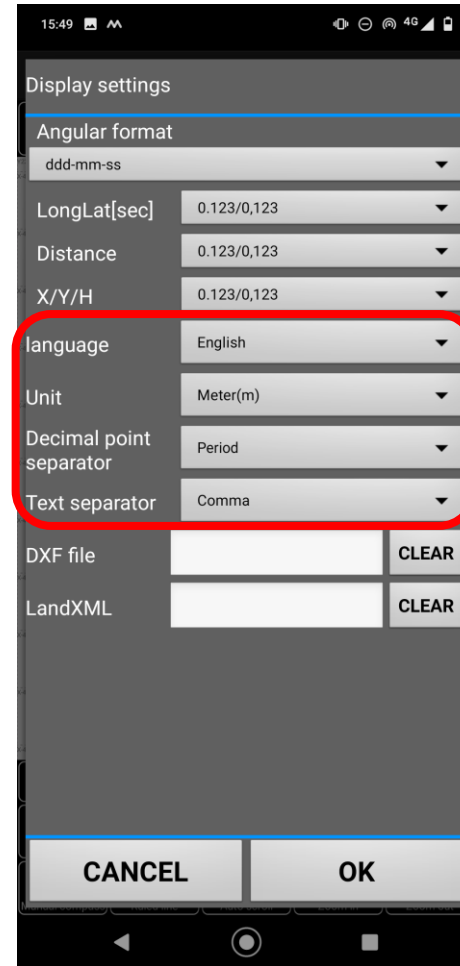

Select the item to be set by tapping its .

Supported languages
English
French
German
Polish
Spanish
Latvian
Lithuanian
Estonian
Dutch
Czech

Chapter 4

Pre-Measurement Checks

4-1. Starting the tablet (Motog7) and [SC Rover]

(1) Power on your tablet.

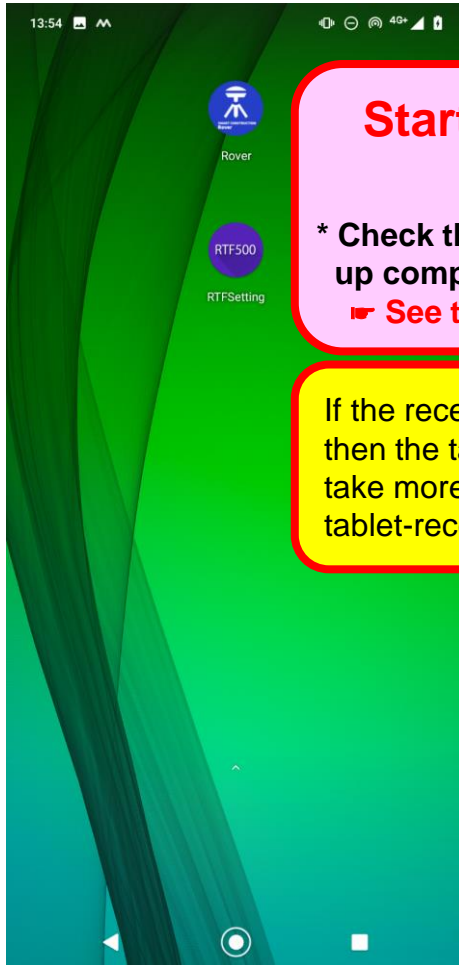

Start the tablet first.

* Check that the tablet has started up completely.
➡ See the next page.

If the receiver is powered on first and then the tablet is powered on, it may take more time to establish the tablet-receiver Wi-Fi connection.



(2) Power on the SC Rover.



- If batteries are in use, press and hold down the power button for approx. **2 s.**
* The [BATT] lamp lights up in green.
- If the external power supply is used, the receiver is powered on by turning on the external power supply.
* The [BATT] lamp lights up in red.

After a while, **all LEDs light up.**
Then, check that **GNSS is on**
and **BT and Wi-Fi are flashing.**

4-1. Starting the tablet (Motog7) and [SC Rover]

Example) Motog7

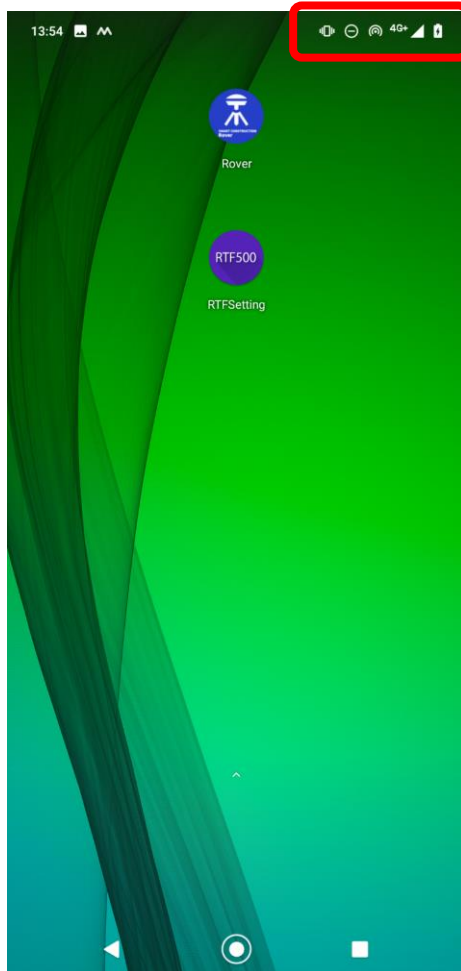

Check the icon on the top right of the screen.

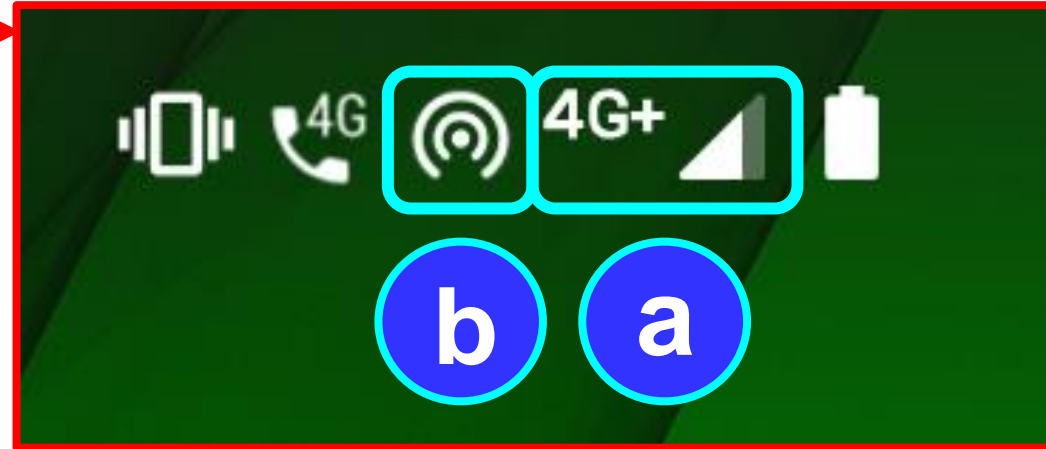

a: Communication status

→ From the communication status antenna icon displayed, confirm that the communication has no problem.

b: Access point startup

→ Confirm that the icon is displayed. (motog7)

4-1. Starting the tablet (Motog7) and [SC Rover]

(3) Swipe down from the top of the tablet screen.

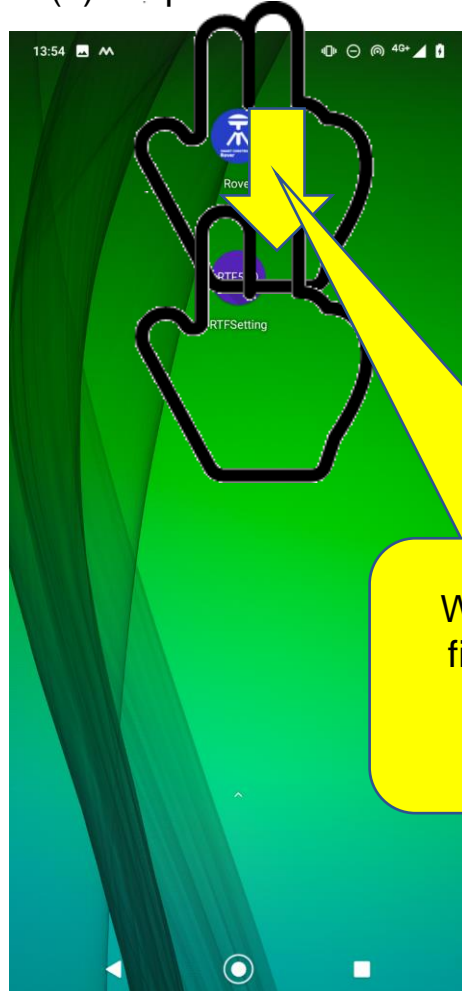

While holding down your fingers on the top of the screen, slide it down.
(Swipe down)

(4) Check the access point.

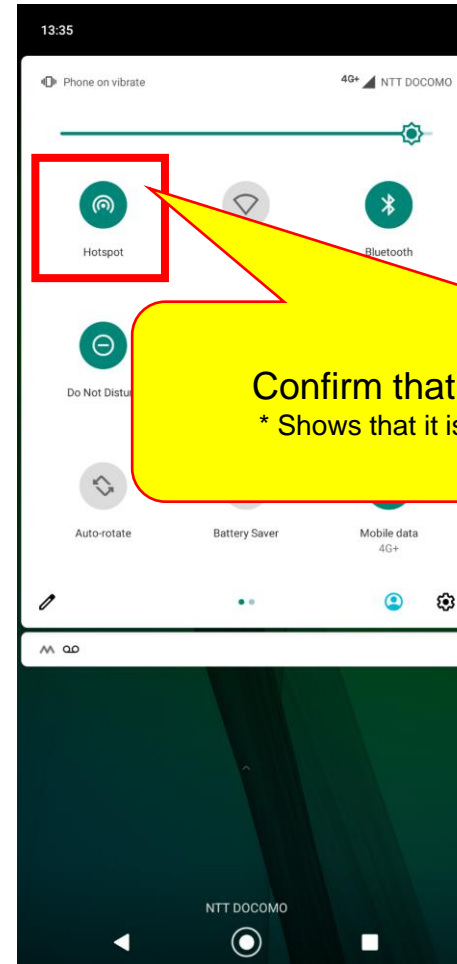

Confirm that the connection is displayed.
* Shows that it is connected to the [SC Rover] in use.

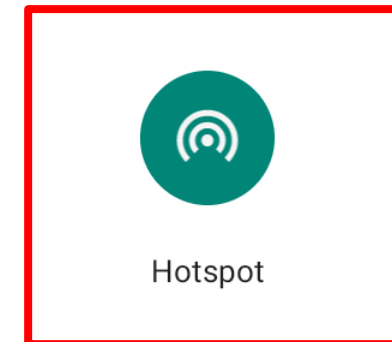

4-2. Starting SC Rover App



Confirm that [GNSS] is on and [BT] and [Wi-Fi] are flashing on [SC Rover]. Then, tap the [SC Rover App] icon to **start** it.

* The location of the icon may differ from this picture depending on the terminal.

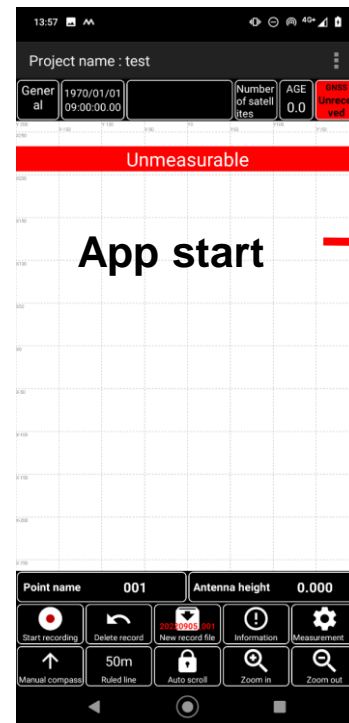

After [SC Rover App] starts up, the [Wi-Fi] LED of [SC Rover] changes from [Flashing] to [On] if paired with [SC Rover].



If the [Wi-Fi] LED of [SC Rover] is [On], this indicates that [SC Rover] and the tablet are **successfully connected**.

* If the [Wi-Fi] LED does not turn on, see "3-3. GNSS settings".

4-2. Starting SC Rover App

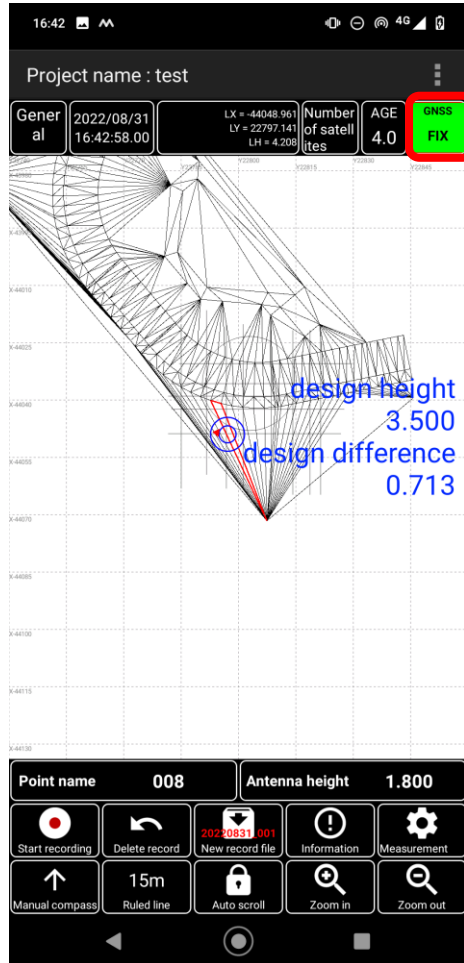

If it is successfully connected with [SC Rover], an icon other than  will be displayed.

For example, **SGPS**, **FLOAT**, or **FIX** will be displayed.

If  is displayed, see "3-3. GNSS settings".

4-3. Inputting the antenna height

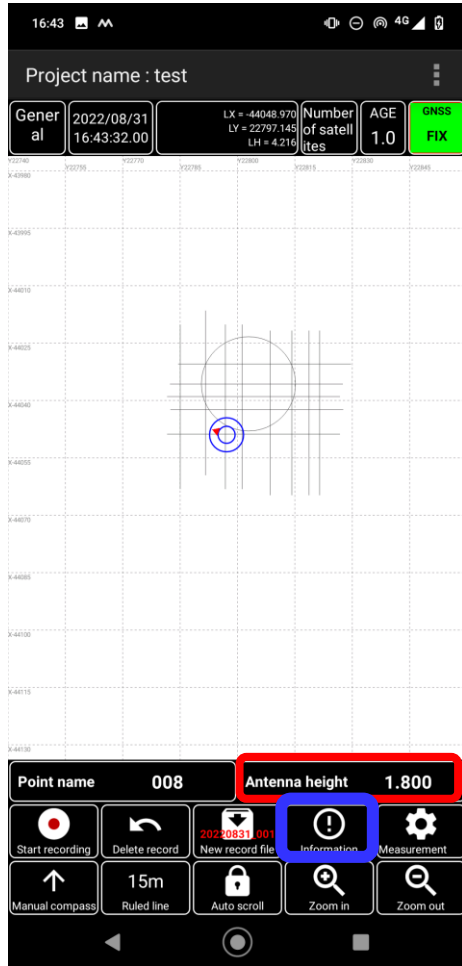

Tap **[Antenna height]**.

* If **[Antenna height]** is not shown on the screen, at the lower part of the screen, tap the **[Information]** button to show it.

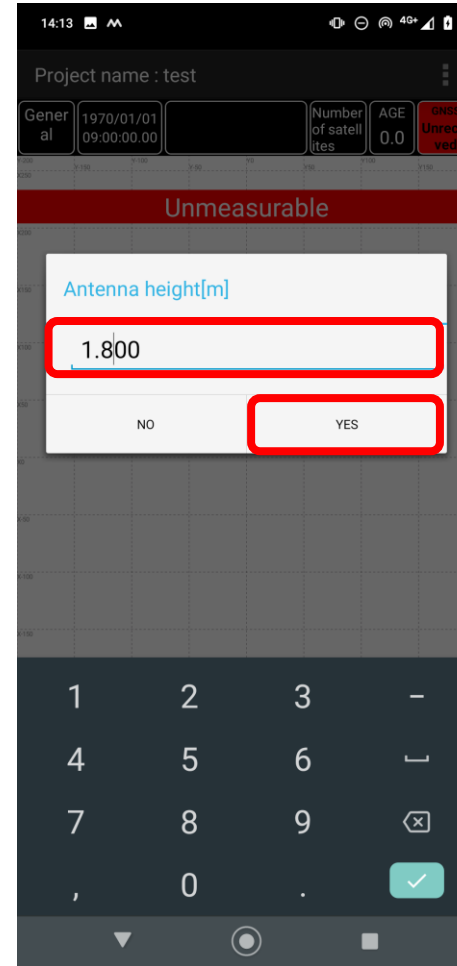

Enter the **[Antenna height]** for measurement and tap **[OK]**.

* If **[SC Rover]** is using an **[AR270]** antenna, the antenna phase center height (0.0368 m) is **automatically taken into account** in **[SC Rover App]**. Thus, all you have to do is to enter **the height of the pole to measure**.

4-4. Selecting the layer

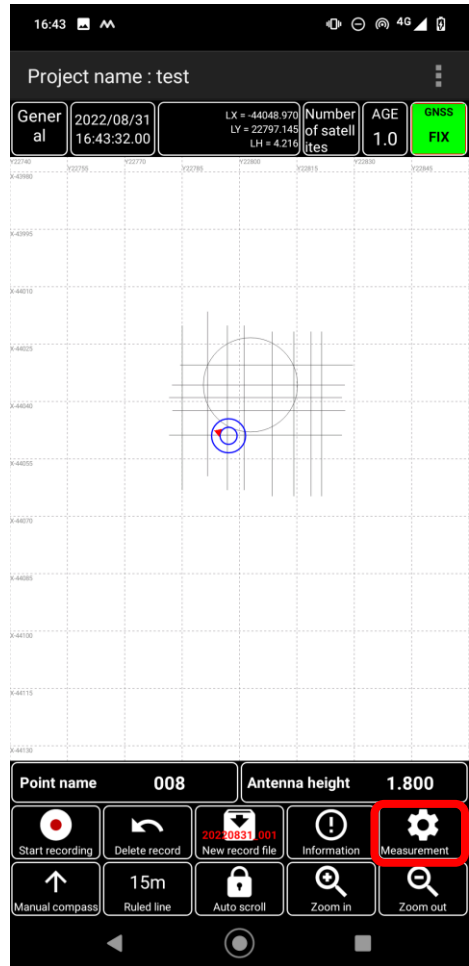

Tap [Measurement].

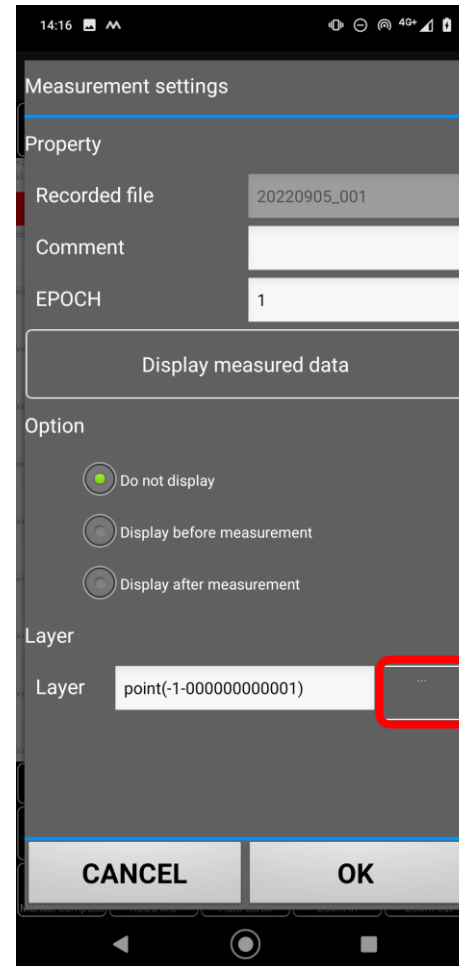

Tap  next to the [Layer] box.

4-4. Selecting the layer

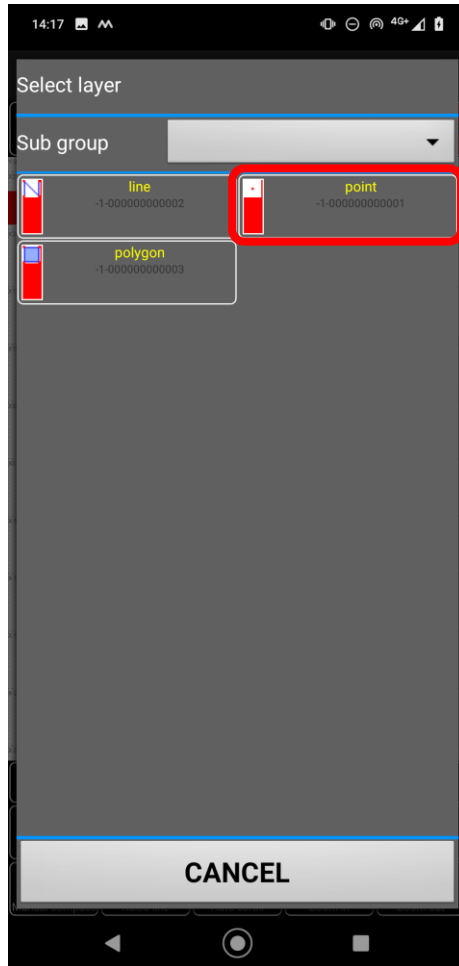

Tap **[point]**.

Normally select **[point]**. However, **[line]** or **[polygon]** can also be used for measurement.

- **[line]**:
For **length** measurement.

- **[polygon]**:
For **area** measurement.

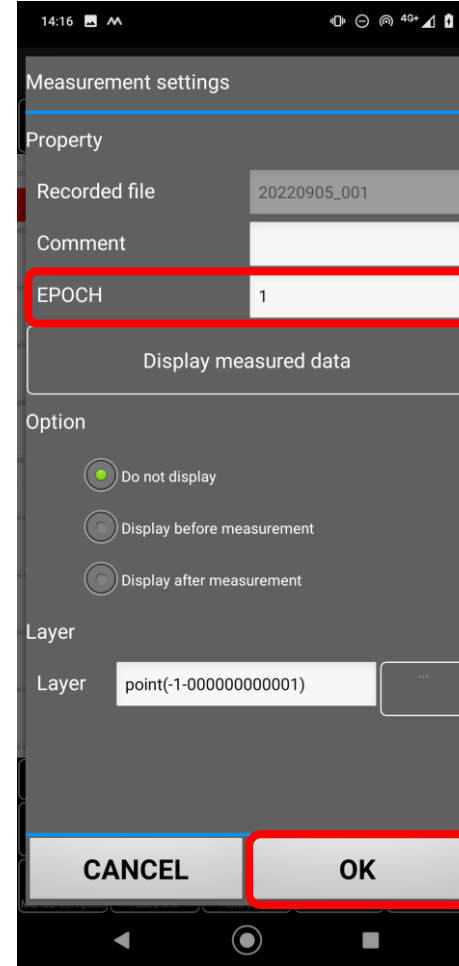

[EPOCH] specifies the number of data items to be averaged during measurement.

[SC Rover] usually outputs 1 Hz (once per second) data; for example, if you set it to [3], the data for 3 s will be averaged.

* This setting is not reflected in the measurement count for performing localization. For performing localization, 10 (EPOCH) is used by default.

Tap **[OK]**.

Chapter 5

Localization

If **[SMART CONSTRUCTION]** is used

A GC3 file is created in the jobsite of the smart construction app linked in the project.

It also enables downloaded to the measurement terminal.

* The GC3 file is created in Data Folder > Completion Drawings > Localization File in the linked smart construction site.

If **[Jobsite Setting]** is used

Although not created on the jobsite, the GC3 file can be downloaded to the measurement terminal.

* Specifications as of July 2022

5-1. Localization actual measurement

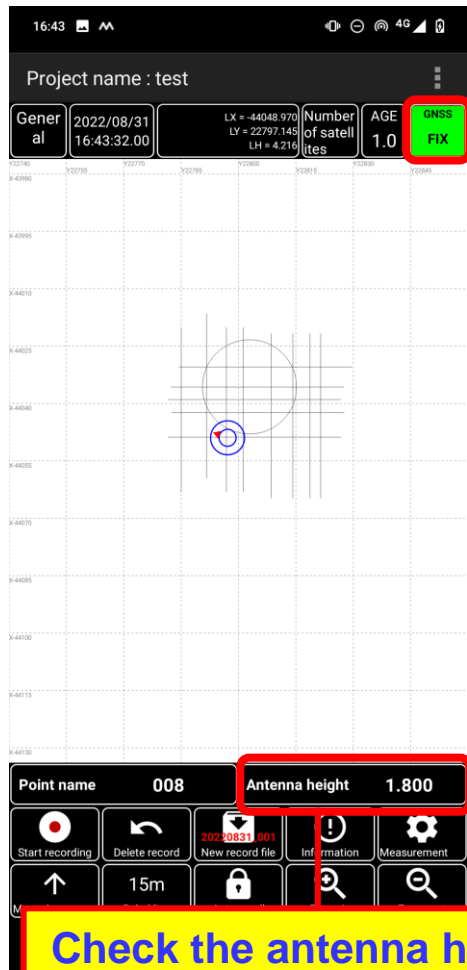

* Check the GNSS solution before measurement.

If GNSS is [FIX] (accuracy: a few centimeters), it is ready for measurement.

■ [FLOAT]

- The number of satellites may be insufficient, or the correction data may have a problem.
 - If an obstacle is present in the sky or nearby, move to a place with better conditions.
 - Check the communication status with the LTE antenna on the upper right of the screen. If LTE communication is unstable, check it after switching to 3G communication.

■ [SGPS]

- No correction data has been received.
 - Check the VRS settings.
 - Check the communication status with the LTE antenna on the upper right of the screen.
 - * Check whether the SIM card has recognized it.

■ [Unreceived]

- It is not connected to [SC Rover], or [SC Rover] is not powered on.
 - Check the GNSS settings or access point connection.
 - * See "3-3. GNSS settings".

5-1. Localization actual measurement

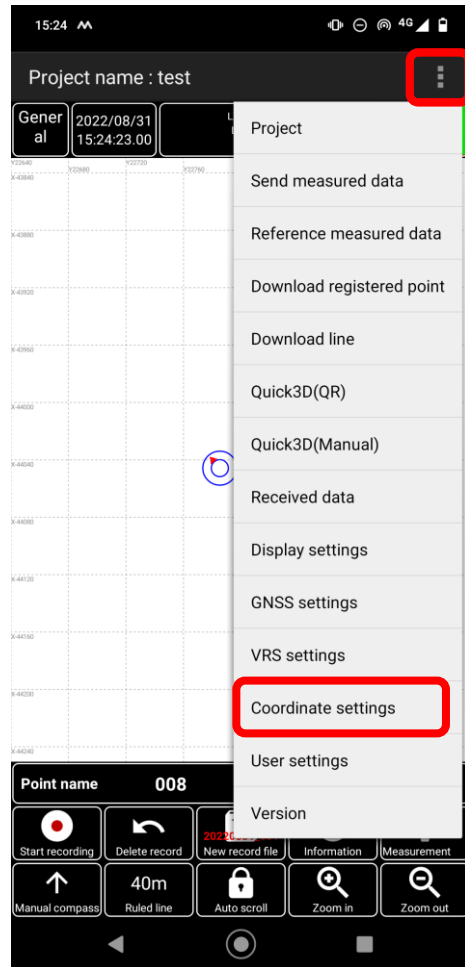

Tap the menu and then **[Coordinate settings]**.

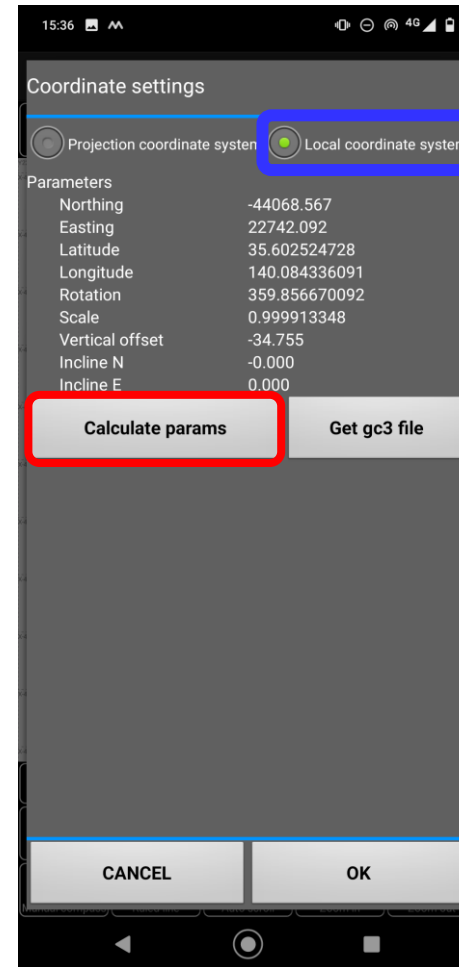

Tap **[Local coordinate system]**.

Tap **[Calculate params]**.

5-1. Localization actual measurement

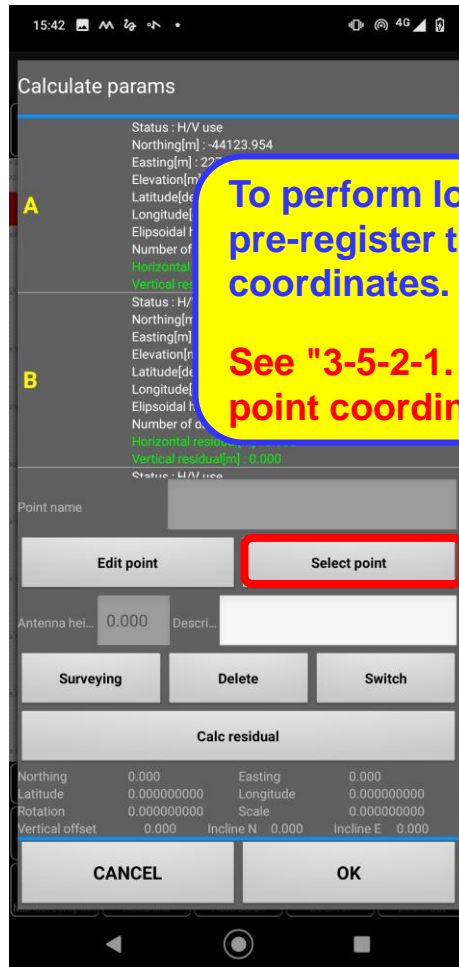

To perform localization, you need to pre-register the reference point coordinates.

See "3-5-2-1. Registering the reference point coordinates".

Tap [Select point].



Tap the point to measure and then [OK].

5-1. Localization actual measurement

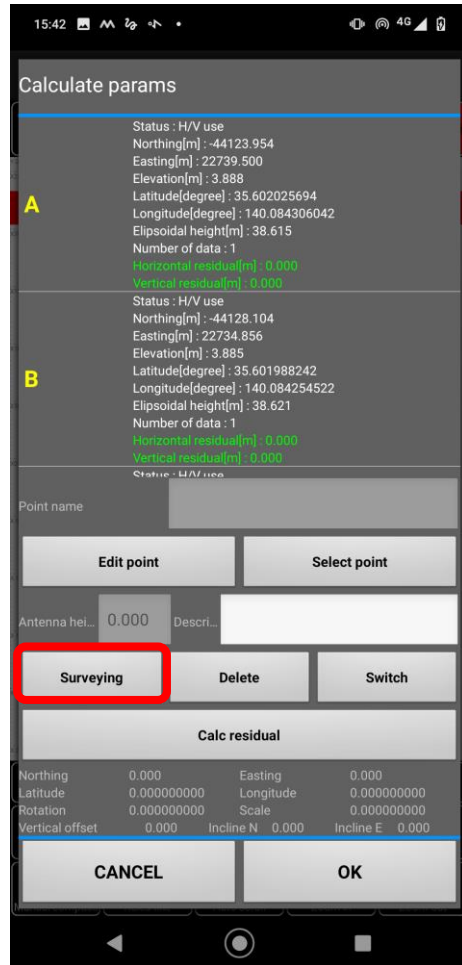

Fix the GNSS antenna on the registration point to measure.

Tap [Surveying].

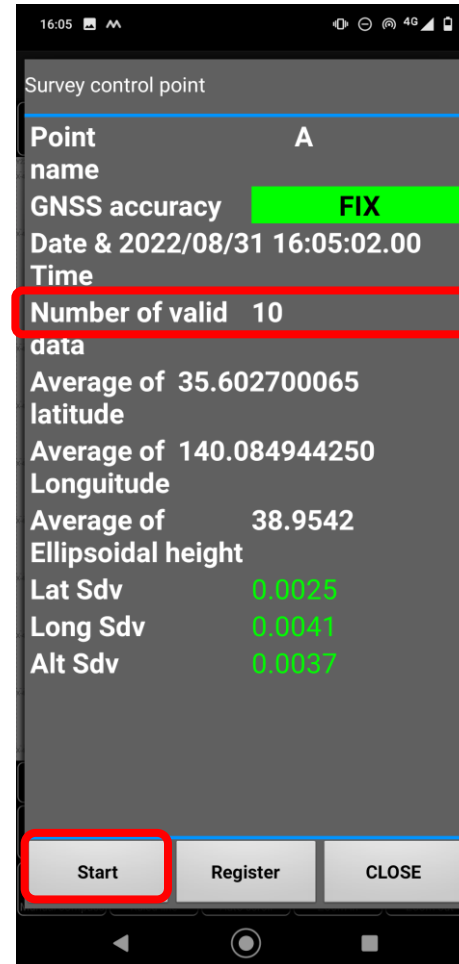

Tap [Start].

Measurement ends when the number of data items reaches [10] by default.

5-1. Localization actual measurement

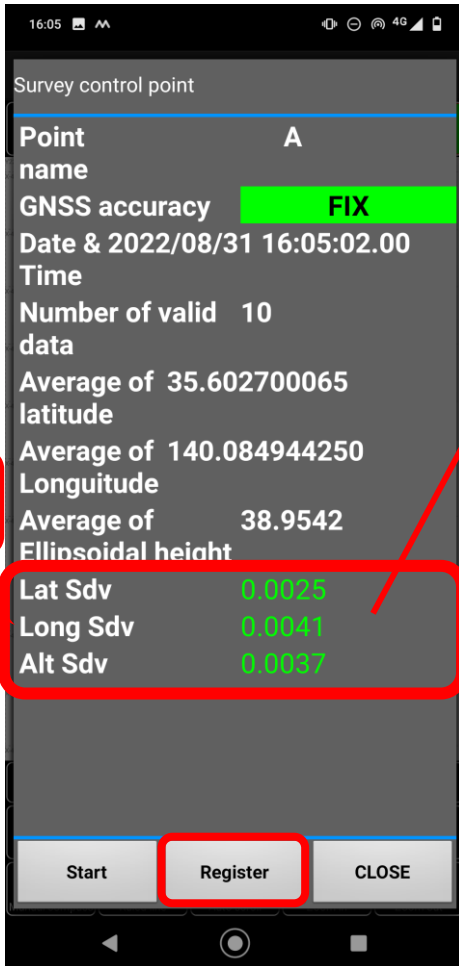

SDs

If an SD exceeds 0.0100, it will be displayed in red letters.

It is recommended to repeat the measurement and registration until every standard deviation (SD) reaches 0.0100 or less.

Check the SDs. If they have no problem, tap [Register].

* To remeasure it, tap [Start] to perform re-measurement.

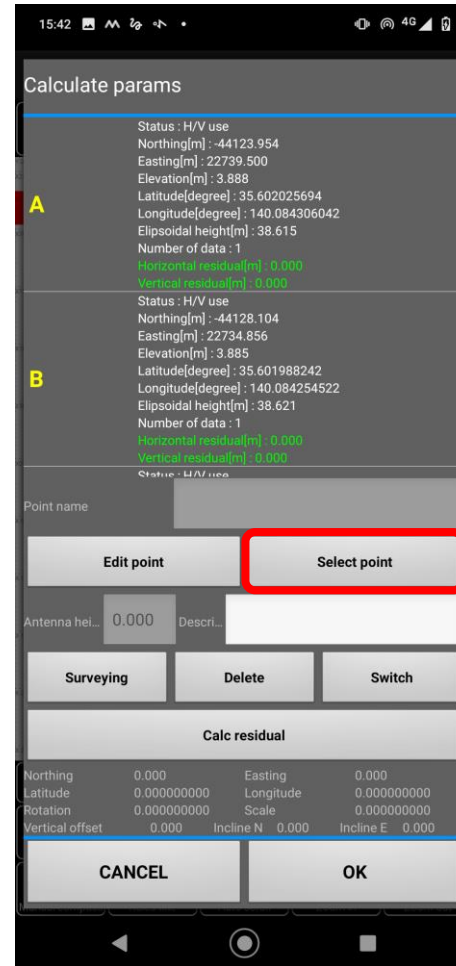

To continue the measurement, move to the measurement points in order.

Then, tap [Select point] and repeat the measurement in the same way.

5-2. Localization guidance function

If three or more points are measured during localization to calculate the residual, guidance can be done to the registration reference points.

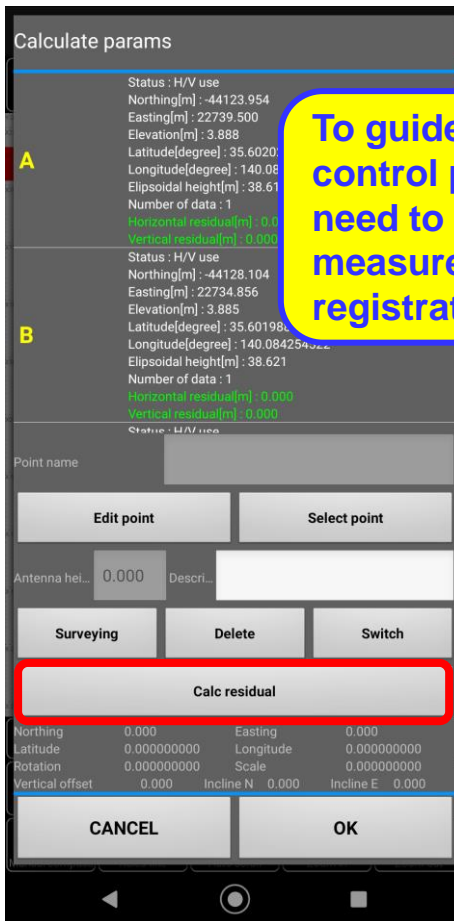

To guide it to the registration control point in localization, you need to perform actual measurements for three or more registration reference points.

After measuring three or more reference points by actual measurement, tap [Calc residual].

* Guidance cannot be done unless three or more points are measured.

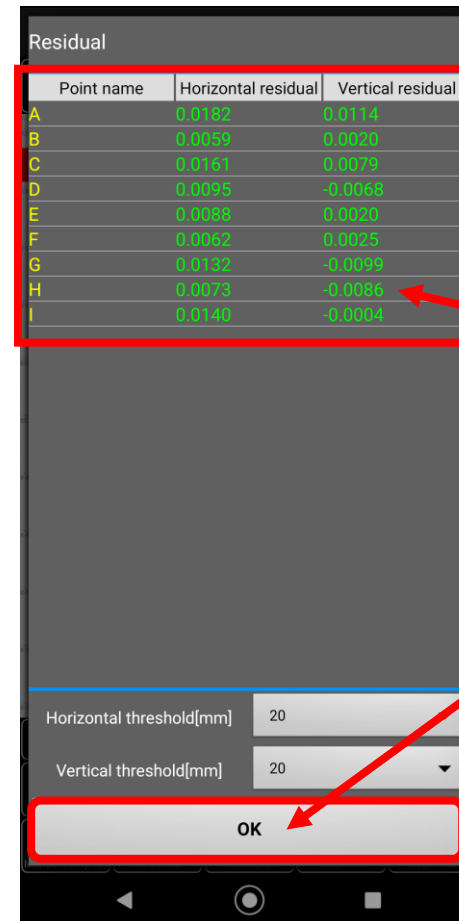

Vertical residuals are calculated at 4 or more points.

Check the residual. If it is in the threshold range, tap [OK].

* If the residual is out of the threshold range, check the registered coordinate values. If they have no problem, perform a re-measurement.

Thresholds can be set between 10 mm and 30 mm for horizontal and vertical directions.

*Normally
Horizontal direction: 20 mm
Vertical direction: 30 mm
Residuals exceeding the threshold are displayed in red.

5-2. Localization guidance function

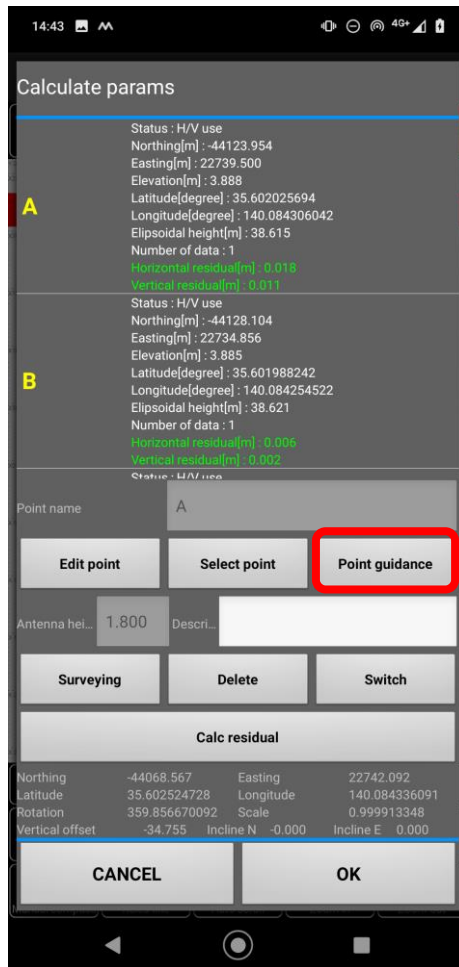

If the acquired residual is in the threshold range, the **[Point guidance]** button appears.

Tap **[Point guidance]**.

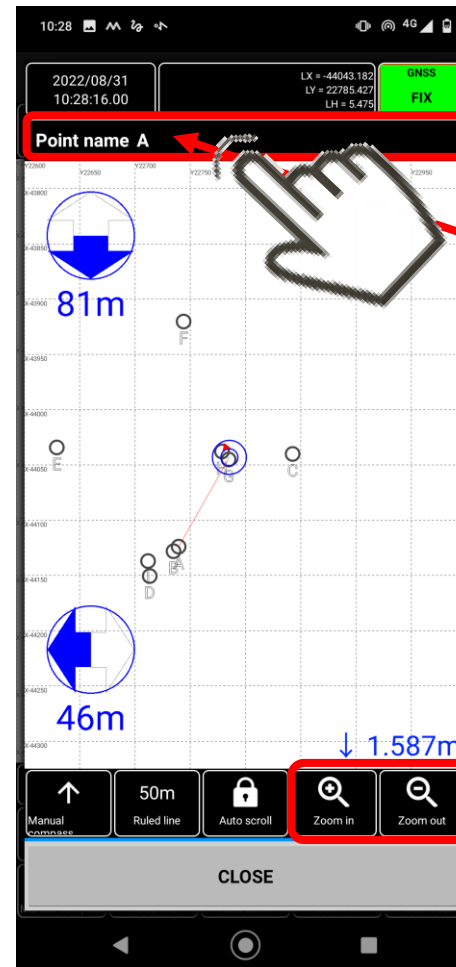

A guidance screen will appear. Select the reference point as the desired guidance destination.

Tap the **[Point name]** box.

Tap **[Zoom in]** or **[Zoom out]** and check the point as the desired guidance destination.

5-2. Localization guidance function



Select the reference point as the desired guidance destination.

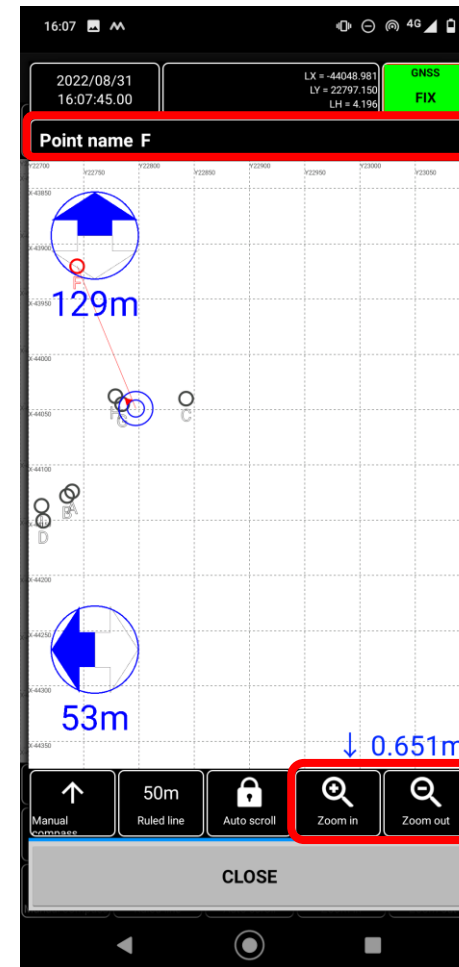

The guidance point can be changed by tapping the [Point name] box to select a point.

Tap [Zoom in] or [Zoom out] and check the selected point.

5-2. Localization guidance function

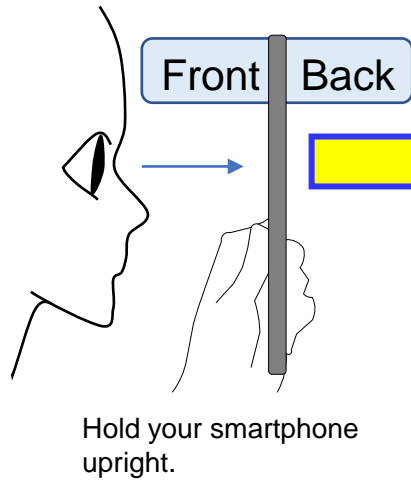

You can stand your smartphone and examine the guidance direction.

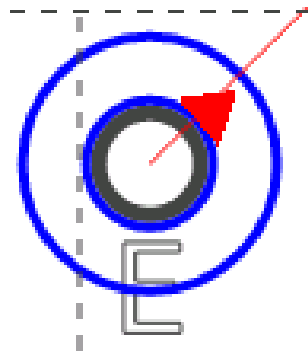

The smartphone is currently facing the triangle vertex direction on the screen.

Point the triangle vertex direction to the selected guidance point and move in that direction.

It is difficult to know the X and Y deviation amounts. Thus, move in the direction of the guidance point without worrying about them.

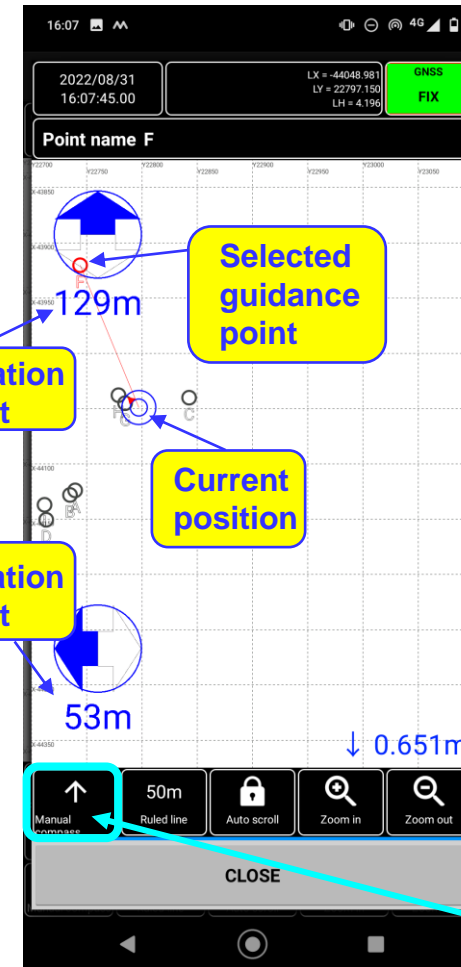

After you can get to know the guidance point, perform the actual measurement.

After this, carry out the guidance and then the actual measurement in the same way.

You can make confirmation by performing residual calculation after each time of guidance and measurement with three or more points.

“Display orientation Manual”
Tap the button to change the orientation above the screen.

5-3. Remeasuring the measured reference point

To make re-measurement

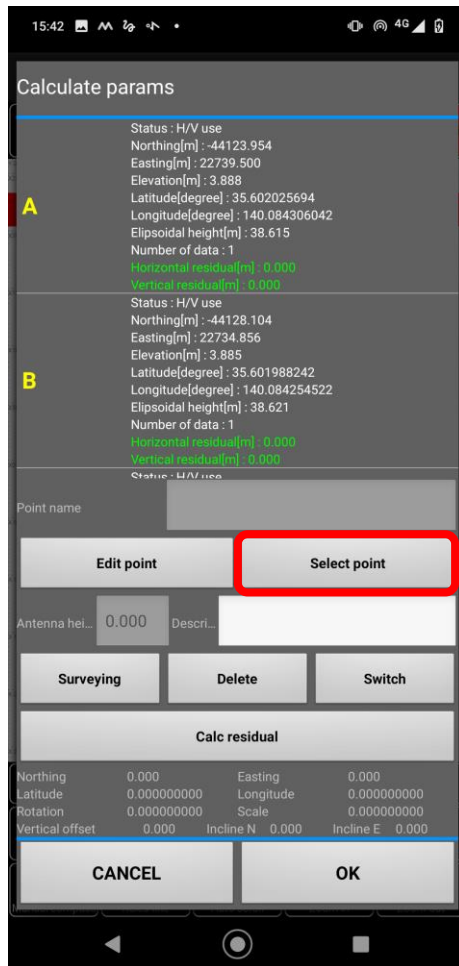

Move to the registration point to remeasure.

Tap [Select point].



Tap the point to remeasure.

Tap [OK].

5-3. Remeasuring the measured reference point

To make re-measurement

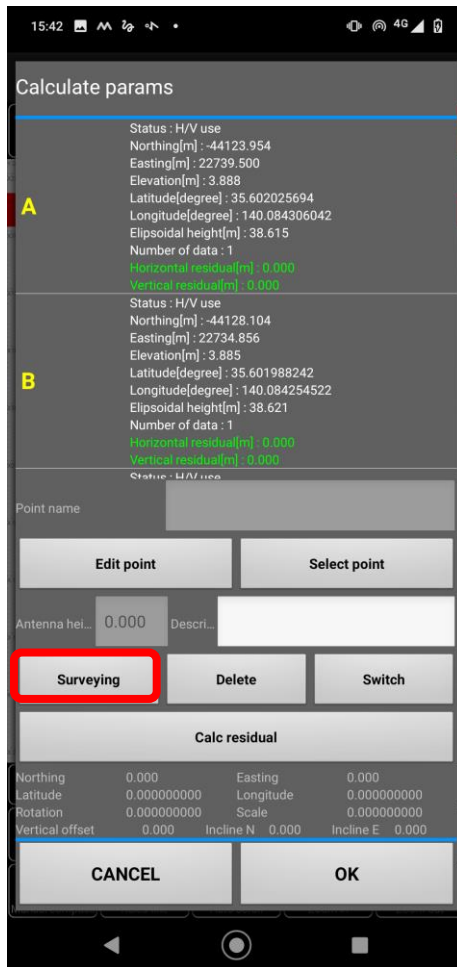

Fix the GNSS antenna on the registration point to measure.

Tap [Surveying].



Tap [Start], and after the measurement is finished, tap [Register]. The measurement coordinates of the re-measured points are **overwritten and registered**.

5-4. Reference point residual calculation

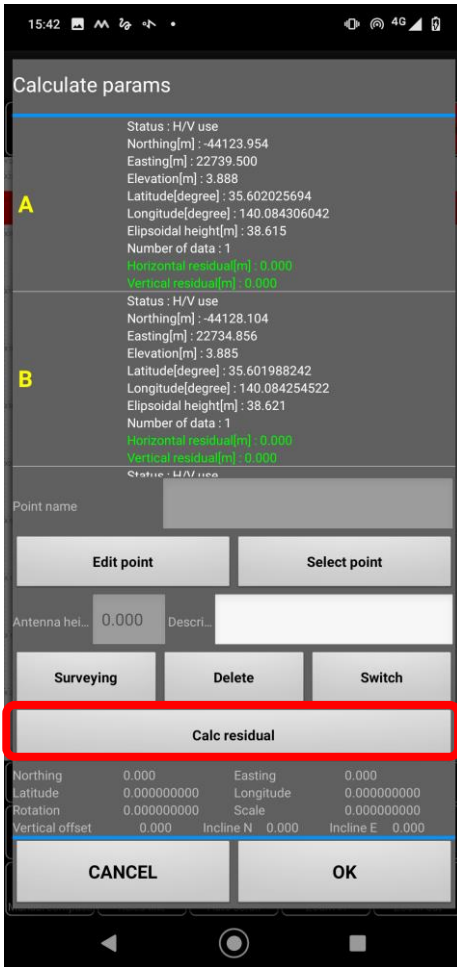

After measuring the registration points registered for localization, tap [Calc residual].

* Residual calculation can be performed when at least four registered points are measured without measuring all of them.

Residual calculation can be checked even during measurement.

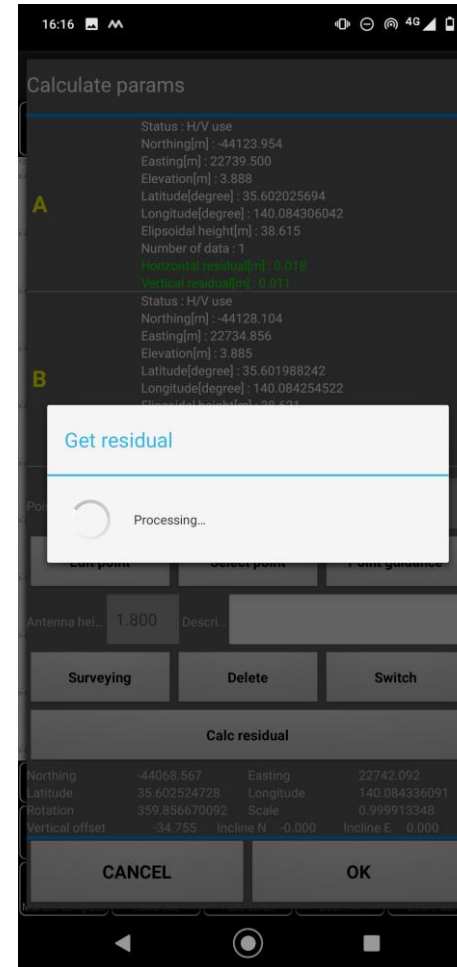

Perform residual calculation via the server.

* Residual calculation is not performed in the application.

Residual calculation or control point registration is enabled only in an environment that enables Internet communication.

When using an external radio out of communication range

If localization is performed using an external wireless modem outside of communication range, for example, the measurement must be followed by moving into communication range to calculate the residuals.

5-4. Reference point residual calculation



Lists the residual calculation results.

Tap [OK] if the residuals have no problem.

If you find a problem in the residual calculation, see "5-6. Switching the use mode of localization measurement points".

Horizontal and vertical thresholds can be set to 10 to 30 mm.
The residuals over the threshold are **displayed in red letters**.

5-5. Registering the control points

If the residual calculation has no problem, register the control points.

Residual calculation or control point registration is enabled only in an environment that enables Internet communication.

Register the local parameters resulting from the localization, i.e. the **[control points]**.

* If it is linked to **[SMARTCONSTRUCTION]** or **[Jobsite Setting]**, the **GC3 file** can be created.

* See "3-2-2. Linking to a LANDLOG work".

* See "Chapter 6 GC3 File Download".

Tap **[OK]**.

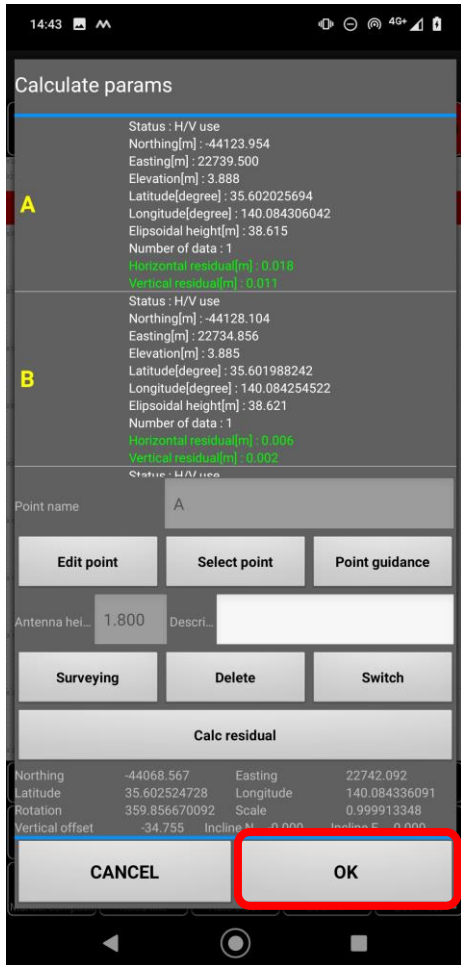

5-5. Registering the control points

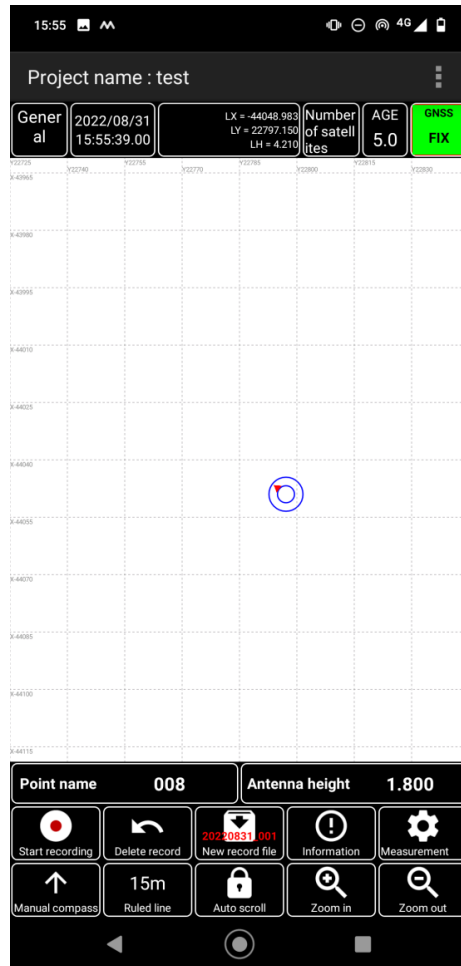

If no error was issued during control point registration, the control points resulting from the localization have been registered.

* **After you register the control points, in that project you can make measurements in the coordinate system where the localization was performed.**

If it is linked to **[SMARTCONSTRUCTION]** or **[Jobsite Setting]**, the **GC3 file** can be created.

* If the project is linked to **[SMARTCONSTRUCTION]**, the **GC3 file will be created** in the Data Folder > completed drawing > localization file.
Also, the GC3 file can be downloaded.

* If the project is linked to **[Jobsite Setting]**, the **GC3 file must be downloaded.**

See "6-1. GC3 file download".

5-6. Switching the use mode of localization measurement points

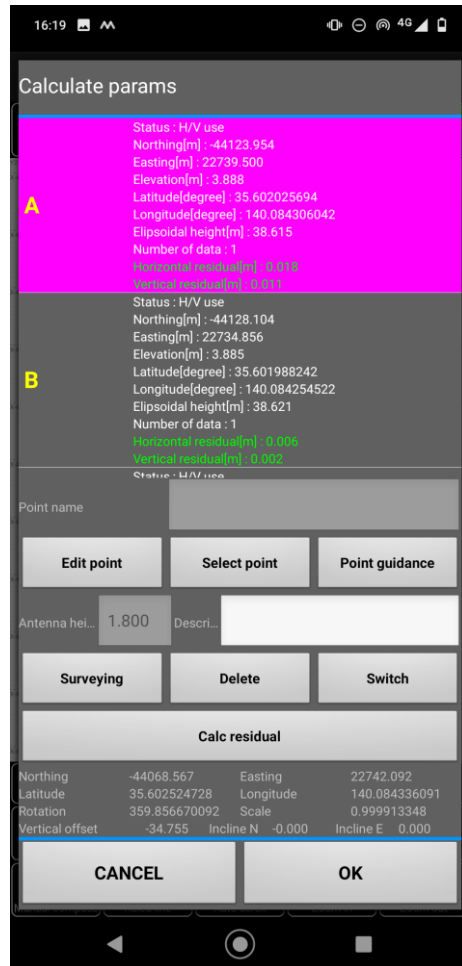

If you find a problem with the residual calculation, tap the point to switch the use mode or disable.

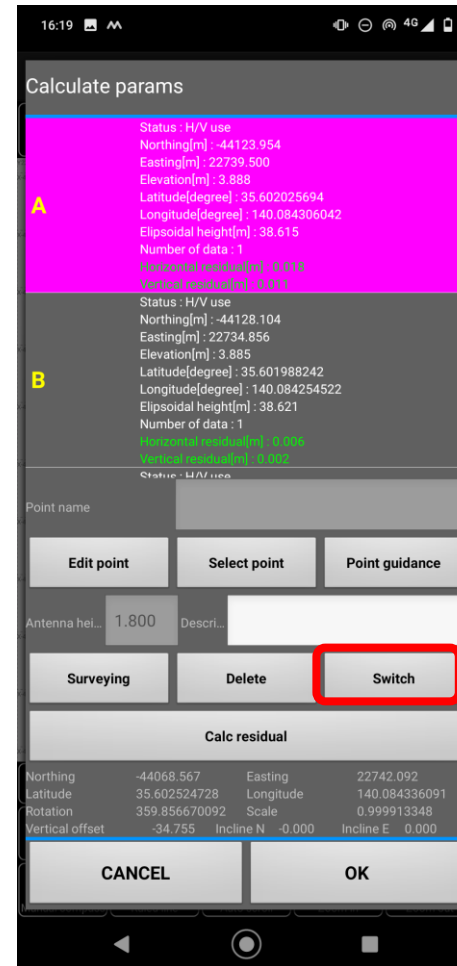

By tapping [**Switch**], the mode can be switched between

- **Horizontal&Vertical Use,**
- **Horizontal Use,**
- **Vertical Use,** and
- **Unused (Disabled).**

* You can select the mode to be used for residual measurement.

5-6. Switching the use mode of localization measurement points

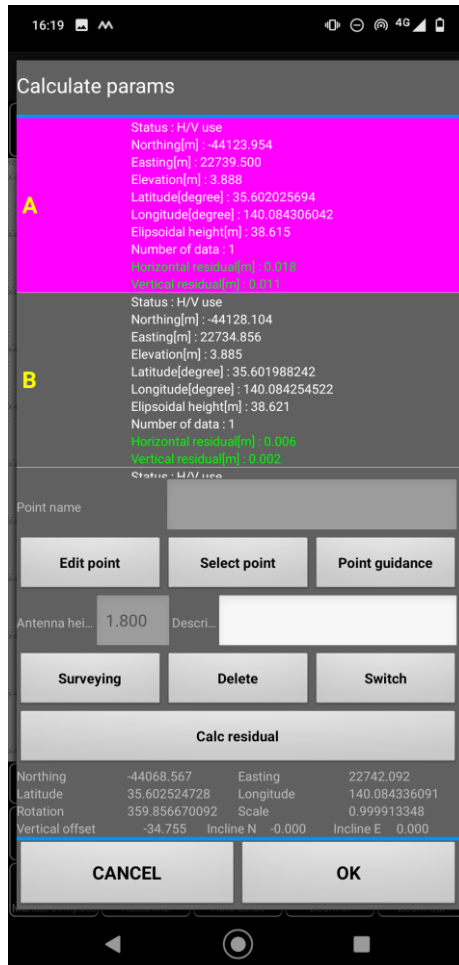

Mode: Horizontal Use

Only the Horizontal Mode is used for residual calculation.

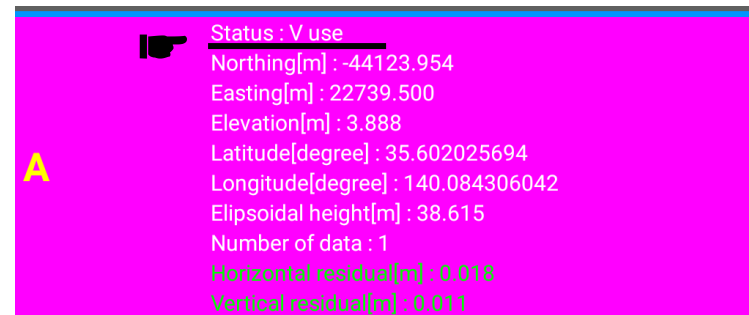

Mode: Vertical Use

Only the Vertical Mode is used for residual calculation.

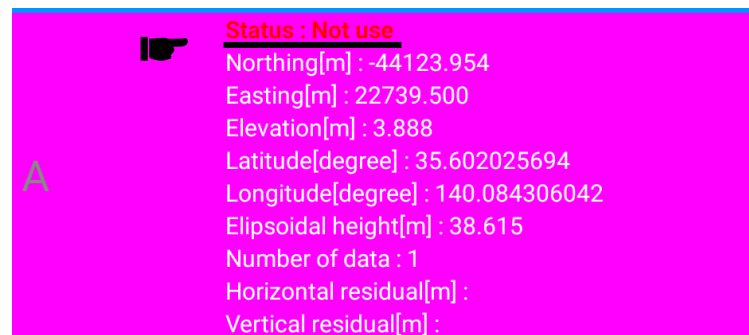

Mode: Unused

Not used for residual calculation.

5-6. Switching the use mode of localization measurement points

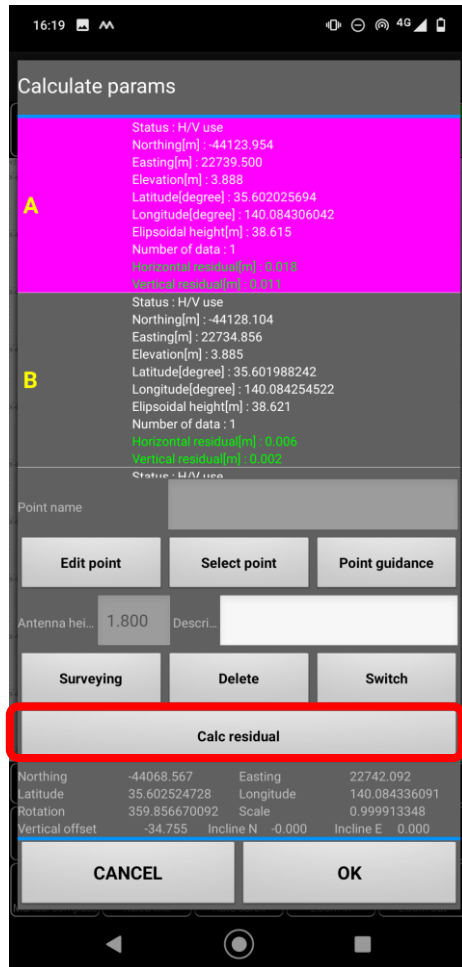

Tap **[Calc residual]** to perform the residual calculation.

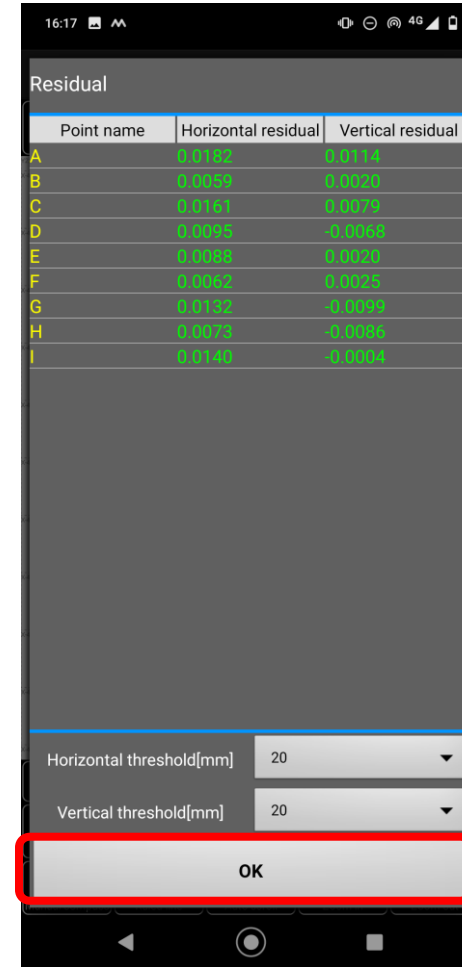

Lists the residual calculation results.

Tap **[OK]** if the residuals have no problem.

For registering the **control points**,

*** See "5-5. Registering the control points".**

Chapter 6

GC3 File Download

To perform the localization and download the GC3 file

The project of [SC Rover App] must be linked to [SMARTCONSTRUCTION] of the LANDLOG work site or the jobsite of [Jobsite Setting].

In addition, the control points must have been registered in localization.

* 3-1-2. Logging in to LANDLOG

* Chapter 5 Localization

★ Irrelevant if you do not use the smart construction app.

6-1. GC3 file download

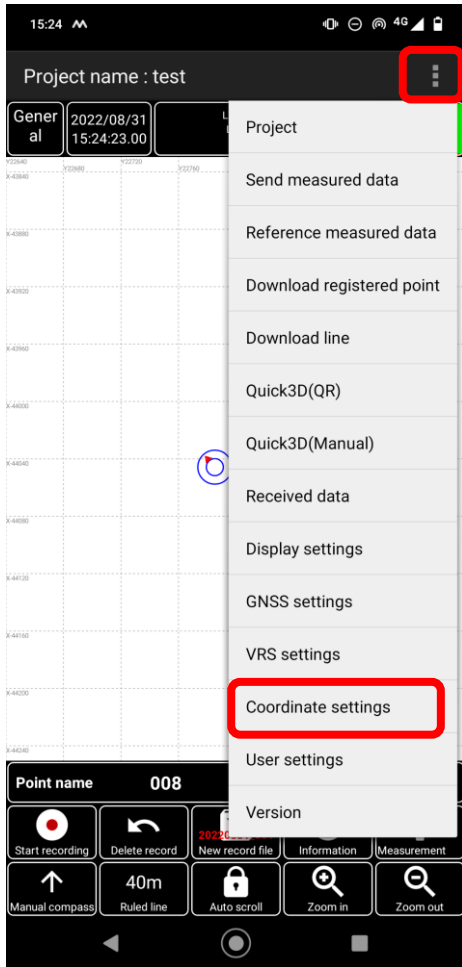

Tap the menu .

Then tap [**Coordinate settings**].

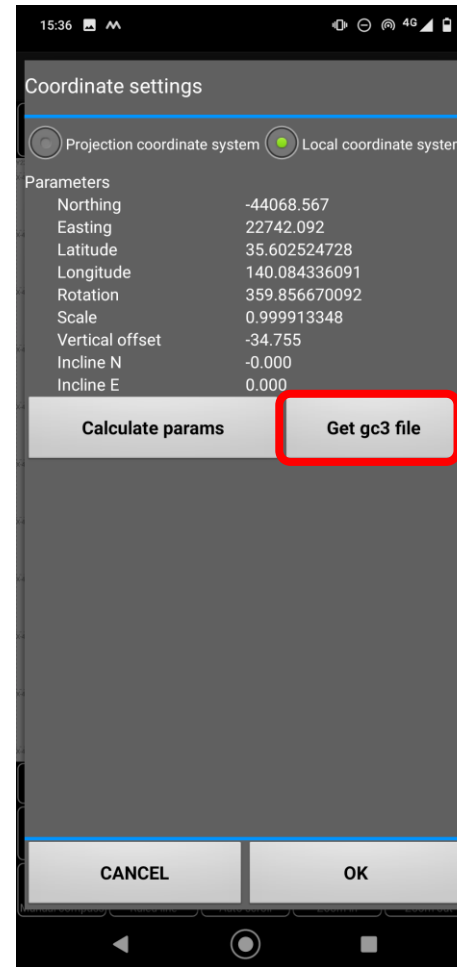

Tap [**Get gc3 file**].

GC3 file download is enabled only in an environment that enables Internet communication.

6-1. GC3 file download

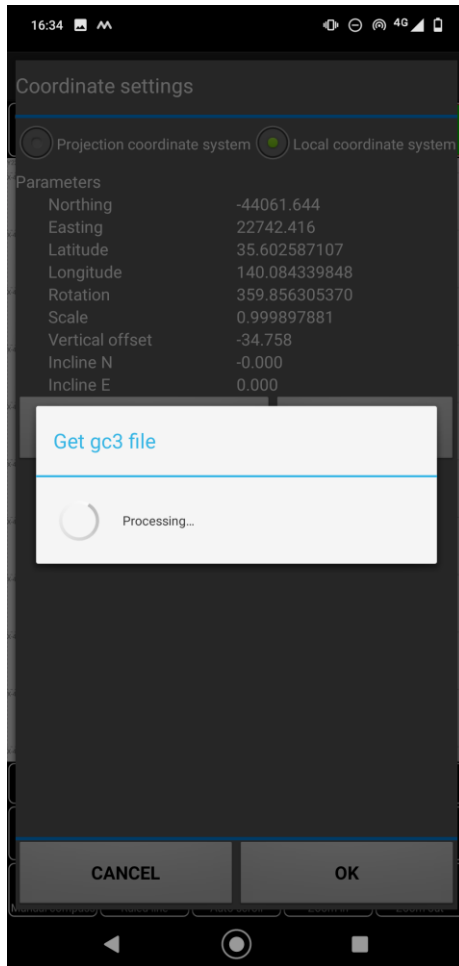

The gc3 file is acquired.

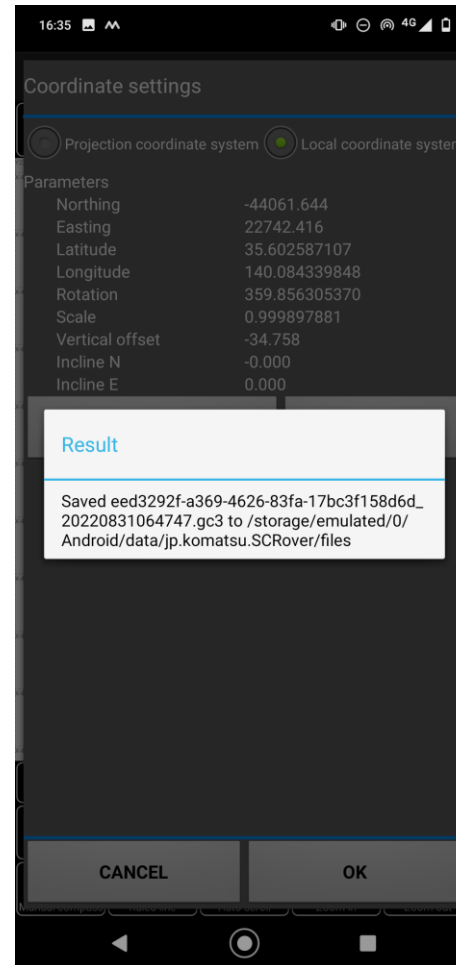

Output to **Internal Shared Storage/Android/data/ip.akt.SC Rover App/files** folder in the terminal.
*** The export destination folder is unchangeable.**

With the terminal and PC connected, transfer the downloaded GC3 file to the PC.

3-5-2-2.
See "(3) Copying and pasting the CSV file to the terminal".

Chapter 7

Measurement screen

7-1. Measurement screen

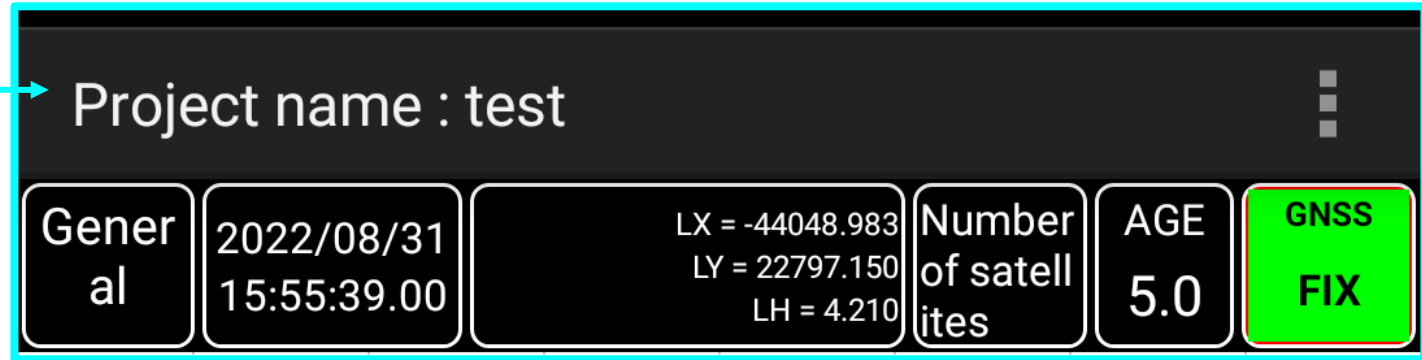
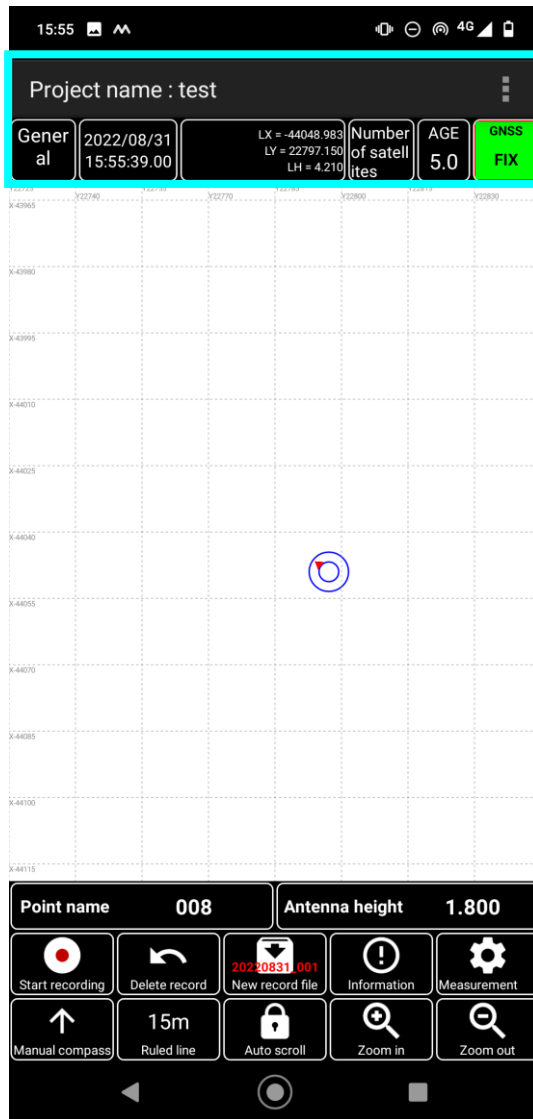

Currently open project



Measurement mode

The measurement mode can be changed by tapping this.



Number of satellites acquired by the mobile station

* Not shared satellites with the base station.
Tap here to check the current satellite constellation.

Menu display

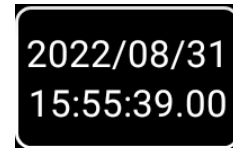

Current date and time

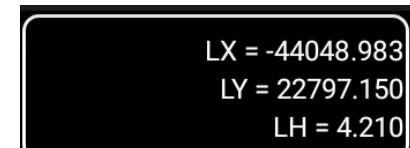

Real time XYH coordinates

Tap here to display the latitude and longitude.



Delay of base station correction data

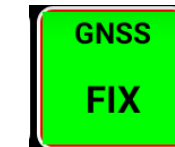

GNSS solution

7-1. Measurement screen

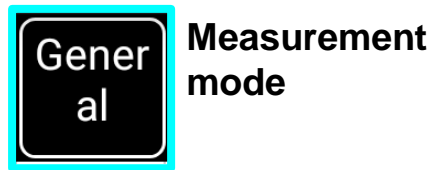
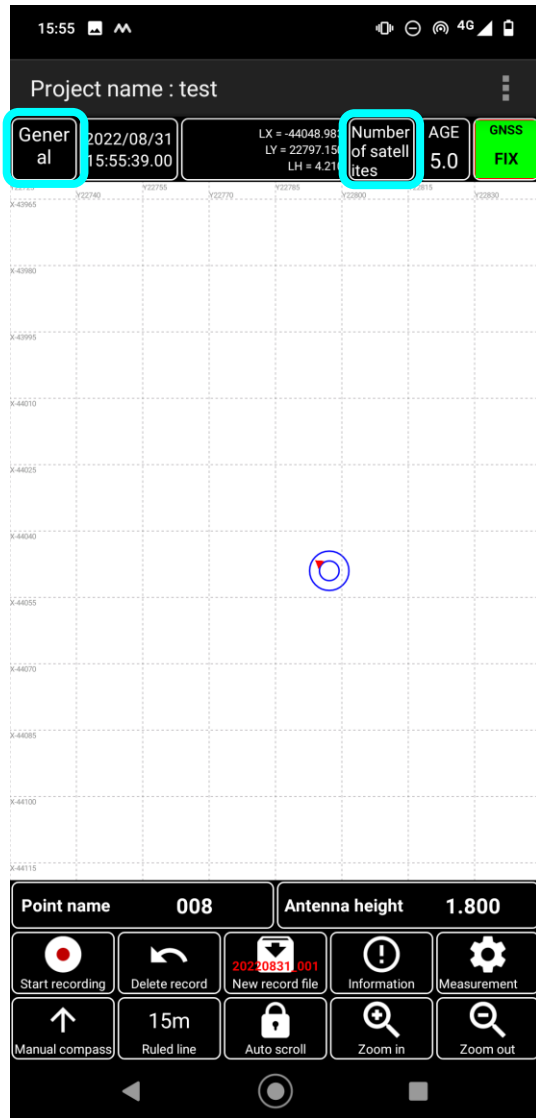

Measurement mode

Tap here to select a measurement mode.
 * For details of each mode, see "Chapter 9. Actual Measurement".

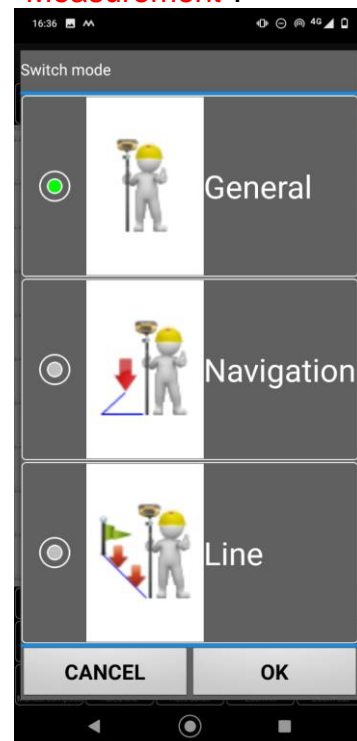

Number of satellites acquired by the mobile station

Tap here to display the number of satellites, constellation status, RMS, etc.

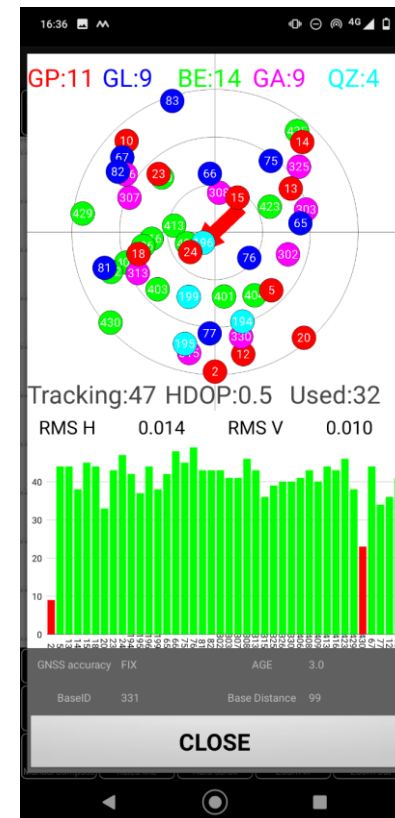

The displayed number of sky plot and that of tracking satellites are not the number of shared satellites with the base station, but the number of satellites from which radio waves are received by the mobile station at an elevation angle of 0 deg. The number of Used satellites is that of satellites within the elevation angle being set on the mobile station.

- To display the number of receiving satellites, the number of sky plot (satellite constellation status), the number of tracking satellites, or L1 SNR (signal strength) for each satellite cluster, your receiver needs to output the NMEA and GSV sentences.
- To display the number of Used satellites, your receiver needs to output NMEA and GNS data.
- To display the RMS, your receiver needs to output NMEA and GST data.

- ▣ Displaying **the status of each satellite** requires the output of the NMEA **[GSV]** from [SC Rover].
- ▣ Displaying the number of **Used** satellites requires the output of the NMEA **[GNS]** from [SC Rover].
- ▣ Displaying the **RMS** requires the output of the NMEA **[GST]** from [SC Rover].
- ▣ Displaying the **base distance (the distance from the base station)** requires the output of the **[Base station distance]** from the [SC Rover].

7-1. Measurement screen

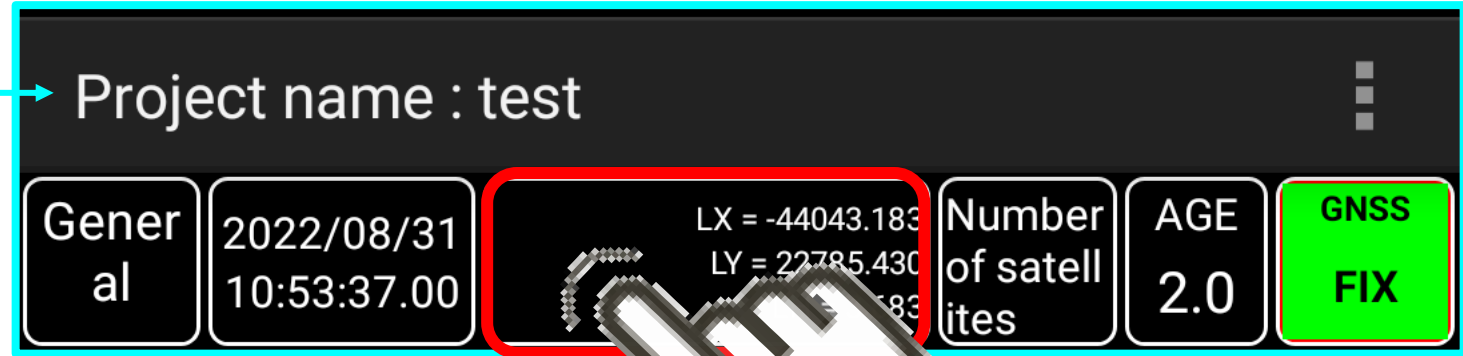
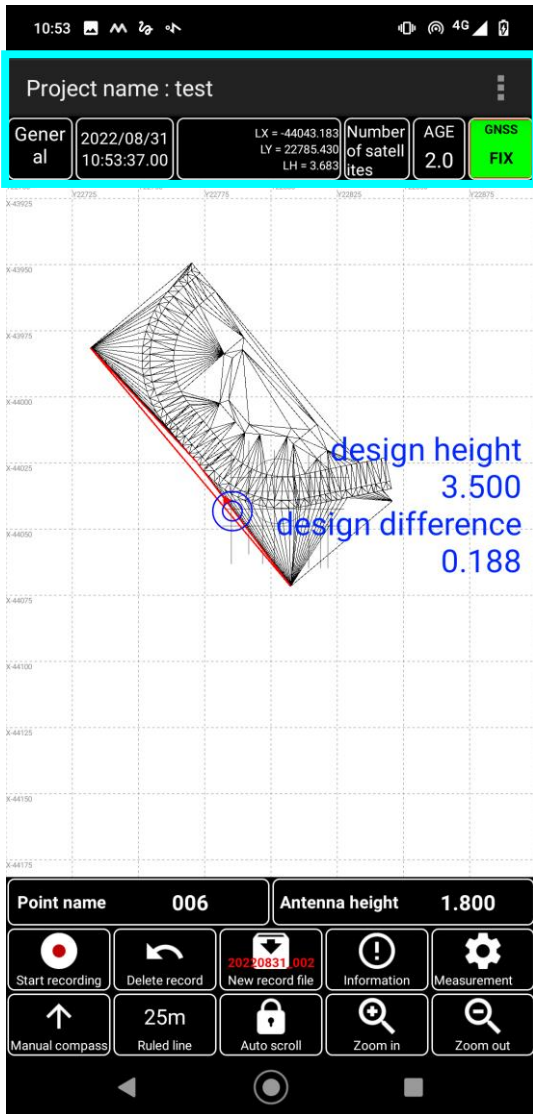

By **pressing and holding down** the coordinate list area, the coordinate list will be enlarged.

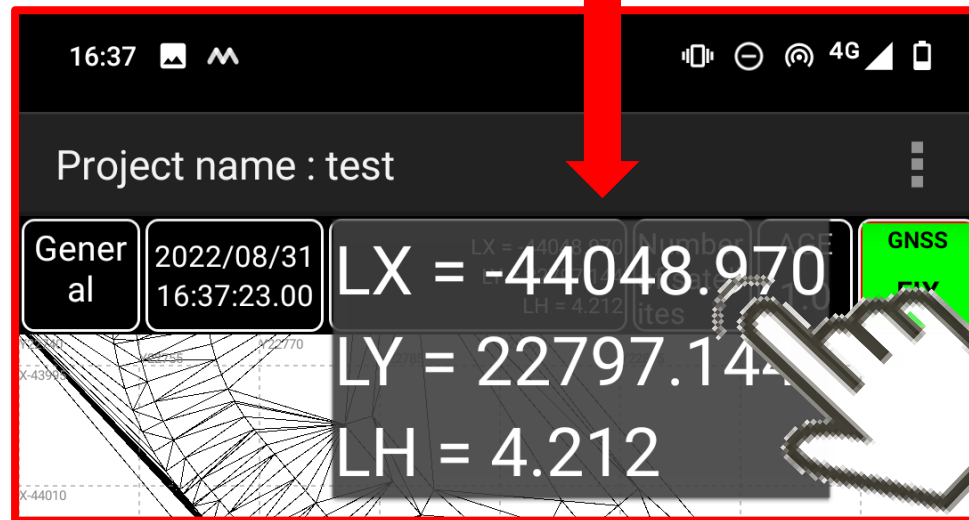

Tapping in the enlarged screen area clears the enlarged display.

7-1. Measurement screen

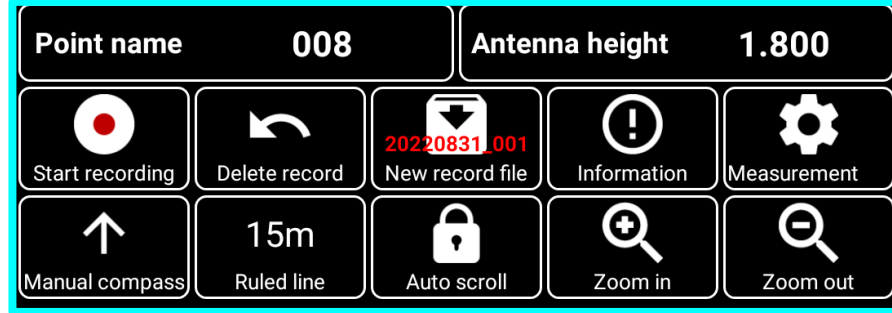
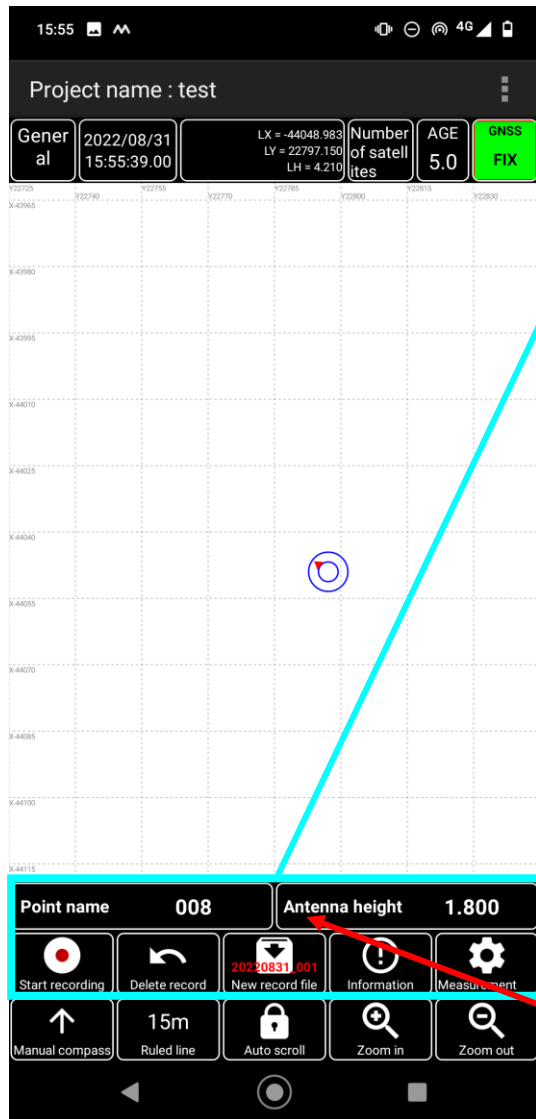

Tap here and enter the point name to record.



Tap here and enter the antenna height.
* See "4-3. Inputting the antenna height".



Tapping here starts recording.



Tapping here deletes the last item of recorded data.



Tapping here creates a new record file.



Tapping here shows/hides the point name, antenna height, etc.
* Normally, set them to be shown.



Tapping here allows you to set the measurement conditions.
See "9-1. General single-point measurement (or Point Measurement)".

7-1. Measurement screen

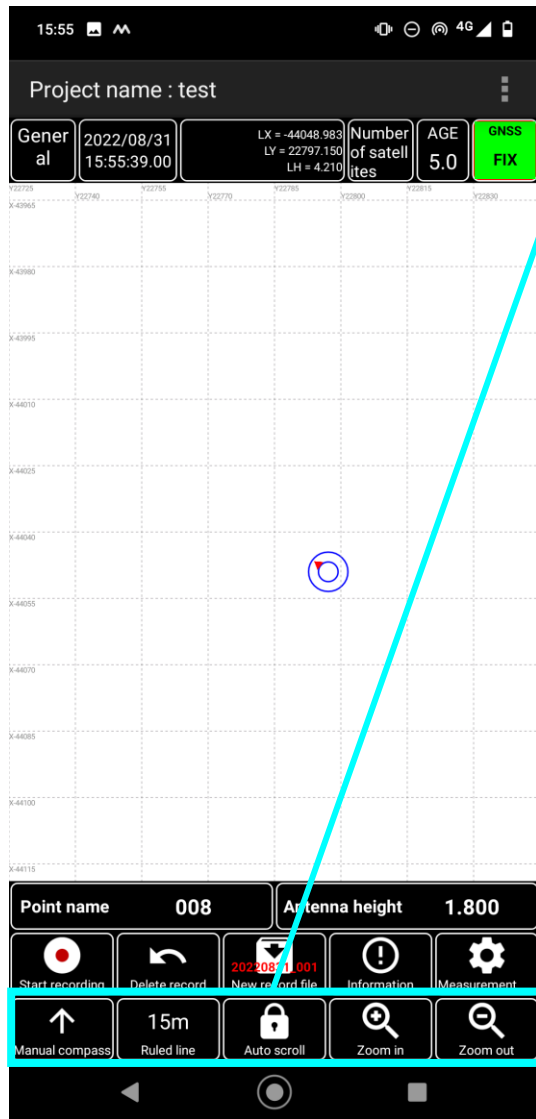

By default, **up** points **north on the screen**.
By tapping here, you can specify the azimuth of the up on the screen.



When ruled lines are shown, the size of **one field of rules** is displayed.
Tapping here hides the ruled lines.
Tapping here again shows them.



If this is [**Auto scroll**], the **current position will always be shown on the screen** during measurement.
By tapping it to [**Manual scroll**], you can **scroll the screen regardless of the current position**.

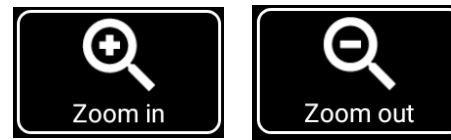

Tapping here **zooms in/out** the screen.

7-1. Measurement screen

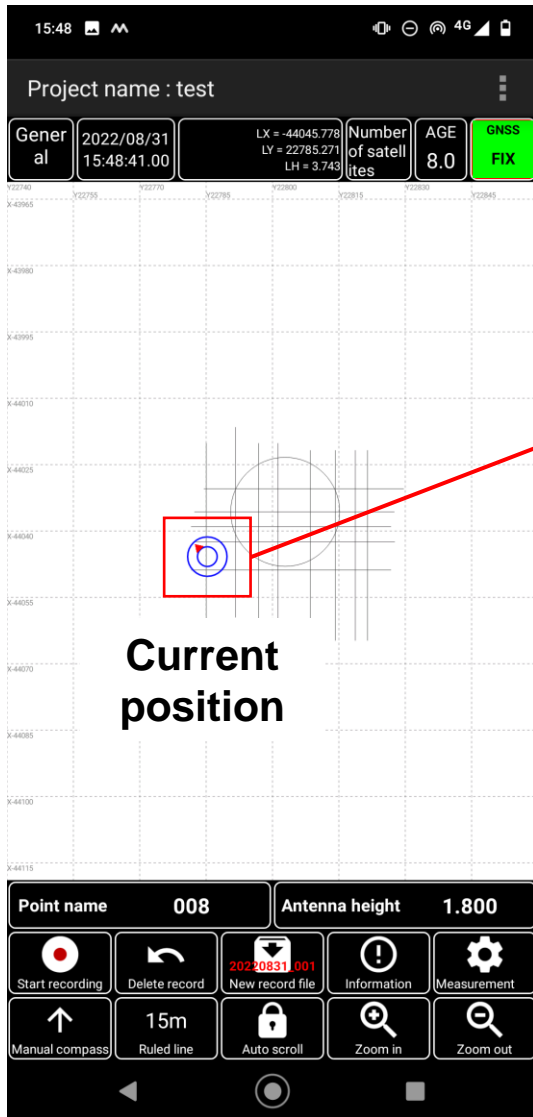

Current position

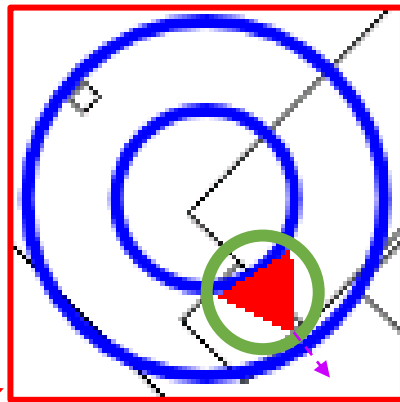

Current position

For Motog7

With the smartphone upright, the direction in which the rear camera is facing is the direction indicated by ▲.

* The smartphone gyroscope is used. (Any terminal without a gyroscope does not enable this function.)

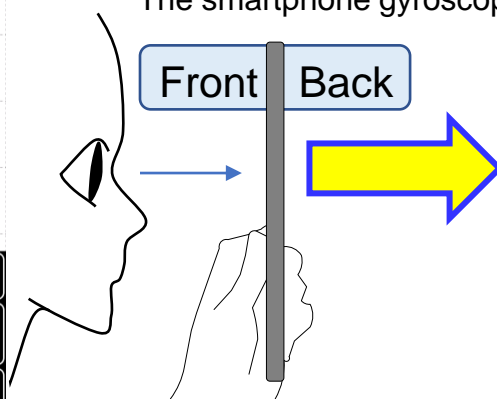

Hold your smartphone upright.

Triangle vertex (▲) display direction

With the smartphone upright, the direction in which the rear camera is facing is the **triangle vertex direction on the screen.**

*** This is useful for reversed placing guidance because it tells you the approximate direction.**

Chapter 8

Importing and Displaying Design Data (LandXML) Files

By importing the LandXML file, you can view the difference from the measured height.

8-1. Importing and displaying design data (LandXML) files

Importing and displaying design data (LandXML)

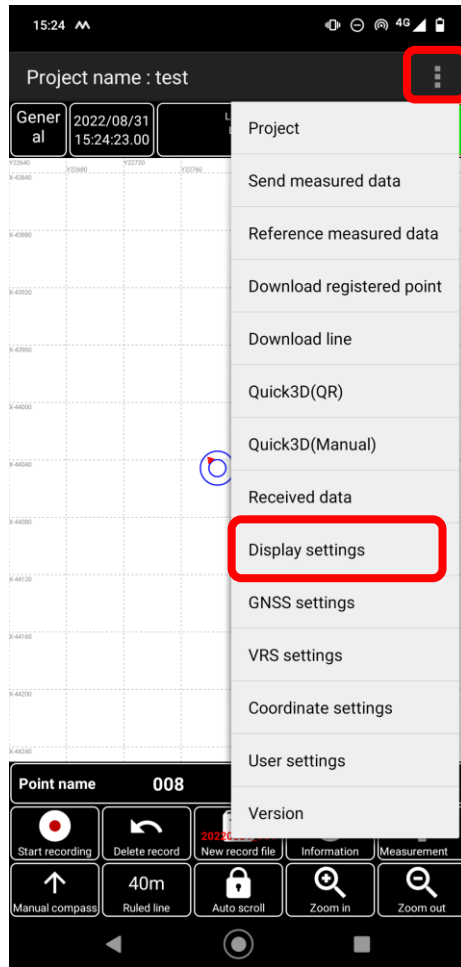

By importing and showing the design data file (LandXML), the difference in height from the design data will be shown on the screen during measurement in each measurement mode (general or reversed placing single-point).

The design data file (LandXML) to be displayed and measured during measurement is copied to the specified folder in the terminal.

* For how to copy data to the terminal, see 3-5-2-2, "(3) Copying and pasting the CSV file to the terminal".

Note: This function does not guarantee the import and display of all LandXML files.

* Reduce the data size as much as possible.

The data file may not be imported/displayed due to a problem included in it. The display of imported data may be affected by the specifications of the terminal used.

What we have verified until now (July 2022) is that after a 6 MB LandXML file is imported, the display and measurements are enabled with the Motog7 terminal.

* This depends on the specifications and usage of the terminal, and operation is not guaranteed.

Example) If the design data file (LandXML) is copied in advance to the specified folder in the terminal.

For details, see "3-6-2. Importing a LandXML file".

Tap the menu  and then **[Display settings]**.

8-1. Importing and displaying design data (LandXML) files

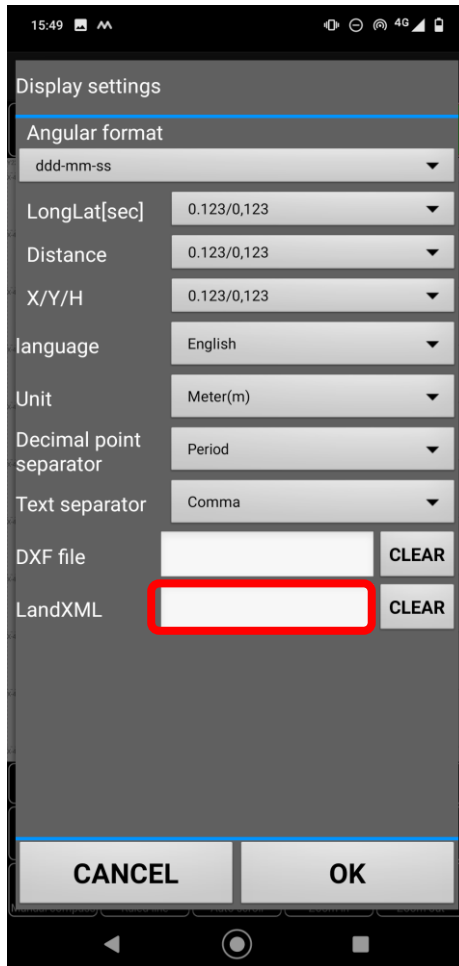

Tap in the [LandXML] box.

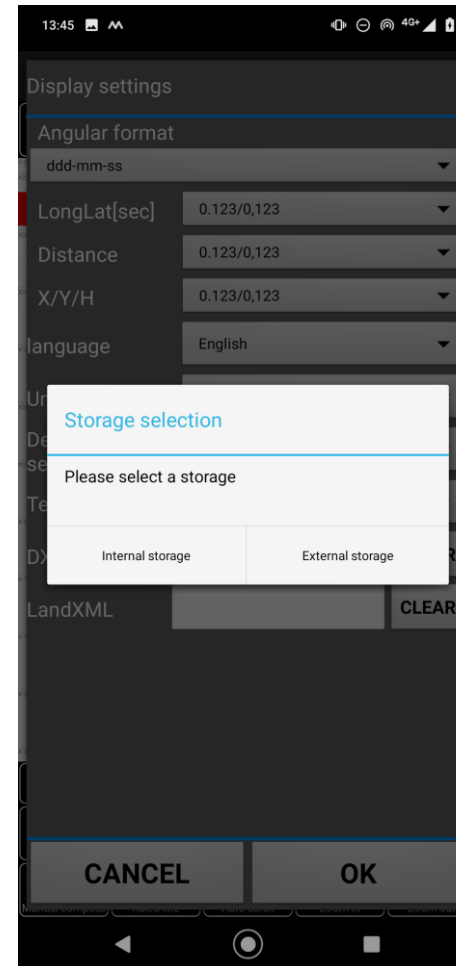

Select and tap [Internal storage] or [External storage] for the destination location to which to import the file.

* Internal storage
Specified importing destination folder
[Internal Shared Storage/Android /data/ip.akt.SC Rover App/files](#)

8-1. Importing and displaying design data (LandXML) files

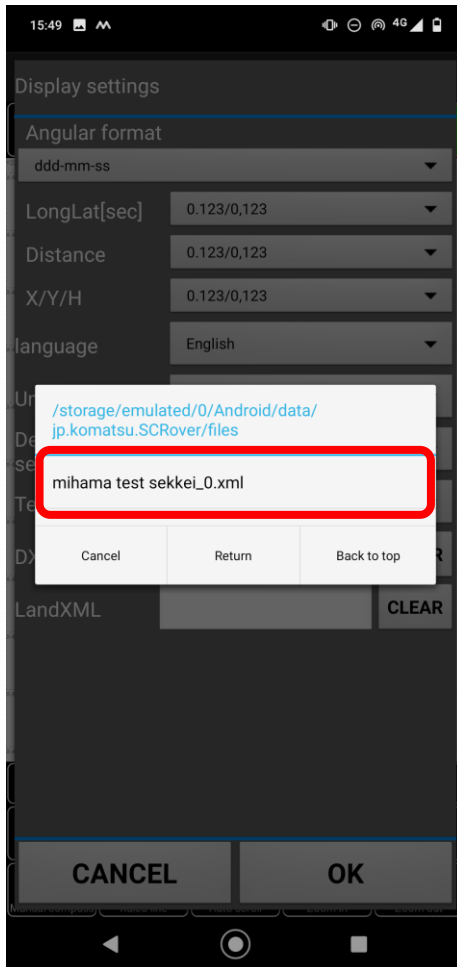

The name of the LandXML file pre-migrated to the specified folder is shown. Select and tap the file to import.

* Specified importing destination folder
Internal Shared Storage/Android /data/ip.akt.SC Rover App/files

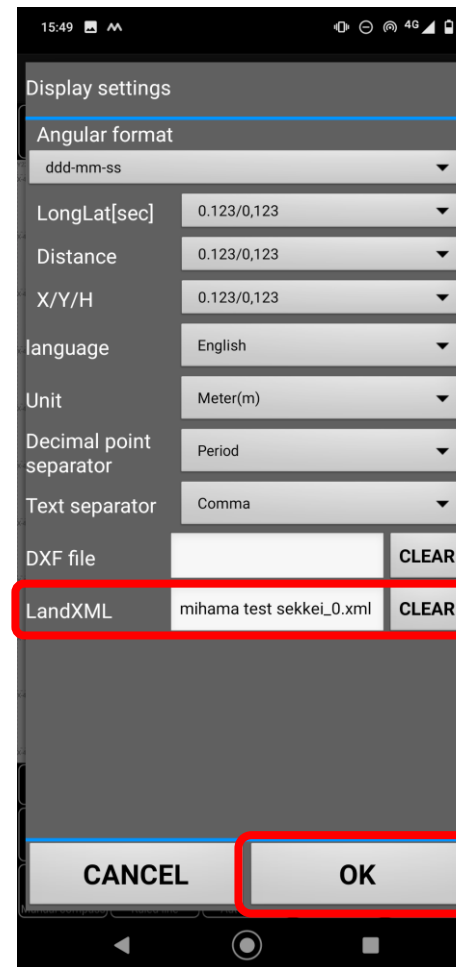

* Hiding the DXF file
Tapping [CLEAR] blanks the inside of the box.
The LandXML file will be hidden by tapping [OK] in the blanked field.

* [DXF] can also be shown at the same time.

Tap [OK].

8-1. Importing and displaying design data (LandXML) files

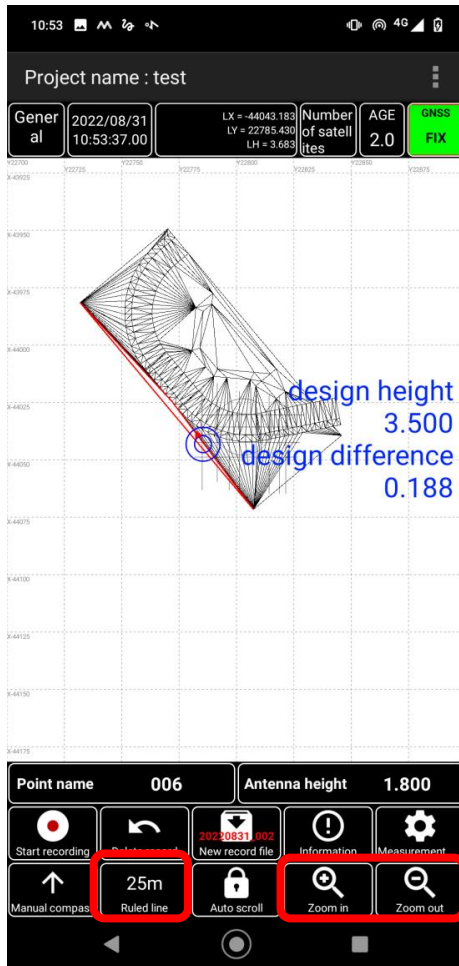

If the LandXML file you tried to import has been successfully imported, it will be displayed on the screen during measurement.

Confirm it with [Zoom in] or [Zoom out].

* Whether display or measurement is enabled may vary depending on the file size and the specifications and usage conditions of the terminal used.

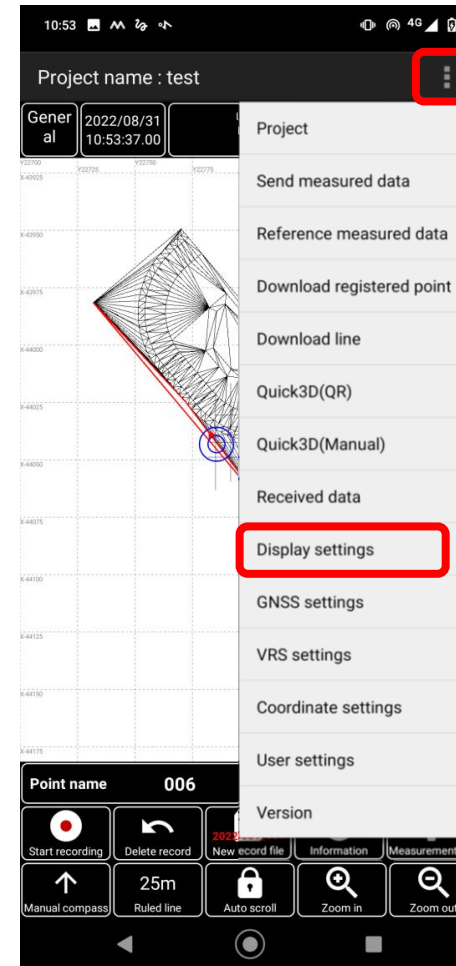

The DXF file imported as a background image can also be displayed simultaneously with displaying the data of the imported LandXML file.

For details, see "3-6-1. Importing a DXF file".

* This function may fail in display/measurement due to the data size of the LandXML file, that of the DXF file to be displayed simultaneously, the terminal specifications, the status of use, and others.

Tap the menu  and then [Display settings].

8-1. Importing and displaying design data (LandXML) files

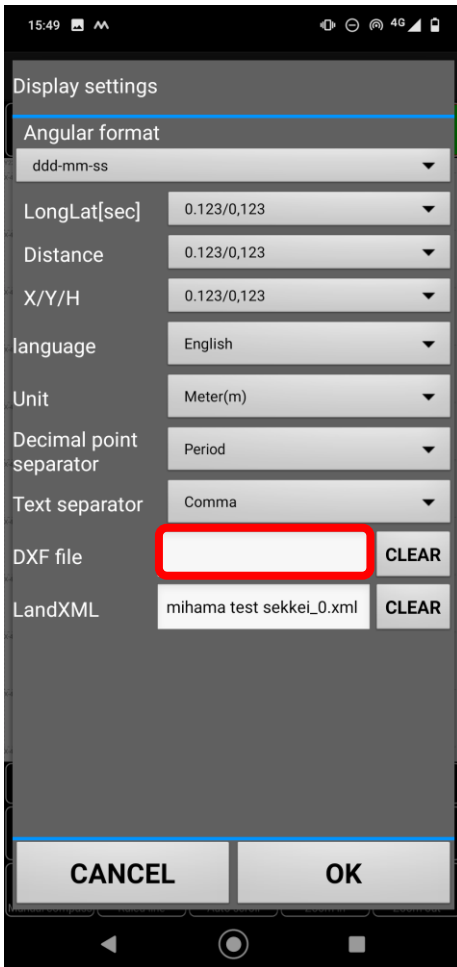

Tap in the [DXF file] box.

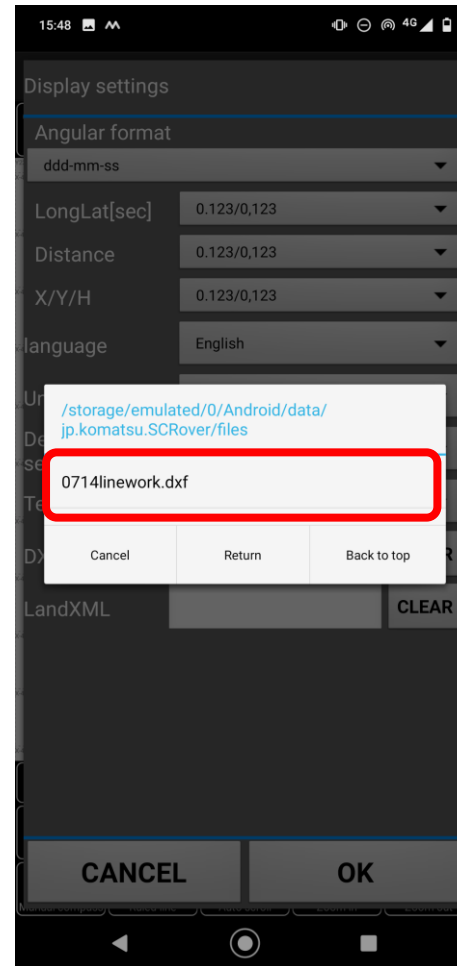

The name of the dxf file pre-migrated to the specified folder is shown. Select and tap the file to import.

* Specified importing destination folder
Internal Shared Storage/Android /data/ip.akt.SC Rover App/files

8-1. Importing and displaying design data (LandXML) files

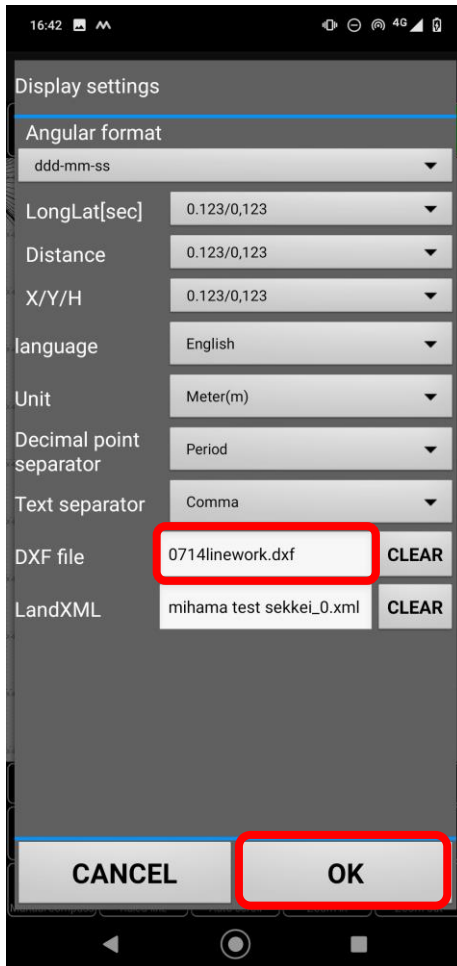

After confirmation, tap [OK].

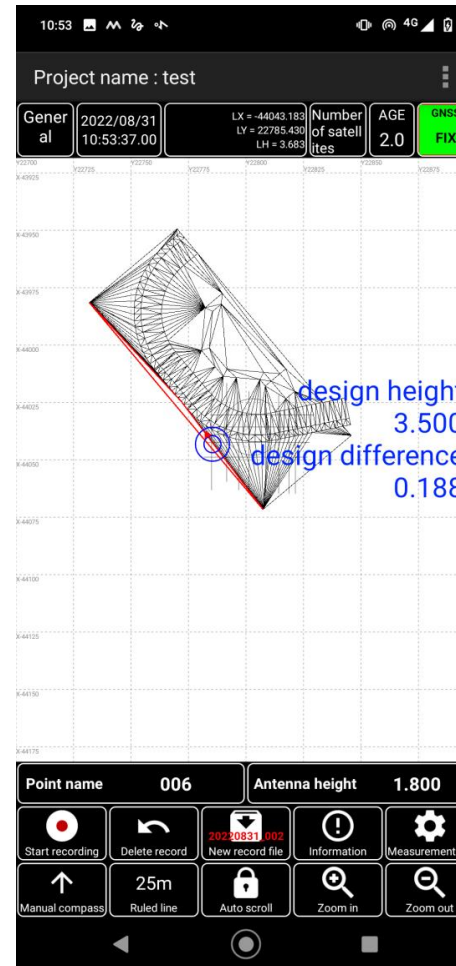

The imported LandXML and DXF files are displayed.

8-1. Importing and displaying design data (LandXML) files



To **hide** the LandXML or DXF file, tap [**CLEAR**].
* LandXML in this example.

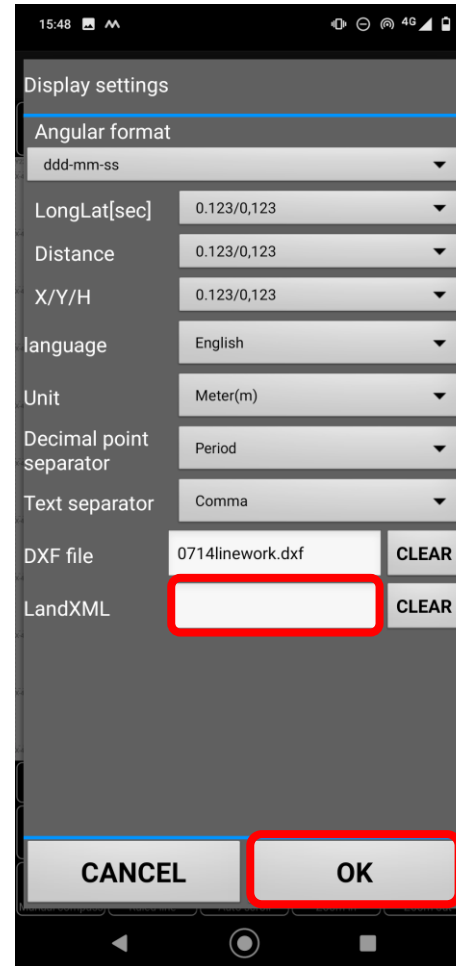

The box will be blank.
Tapping [**OK**] will hide the file.

8-1. Importing and displaying design data (LandXML) files

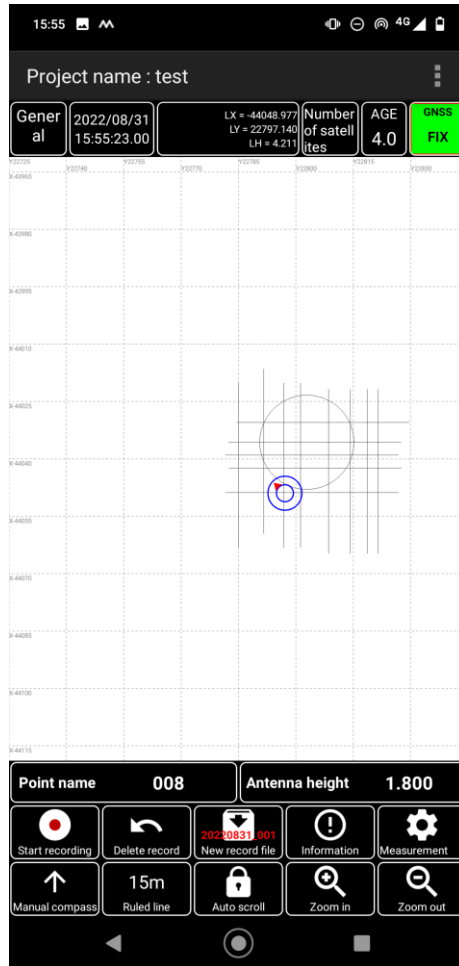

LandXML is hidden.

8-1. Importing and displaying design data (LandXML) files

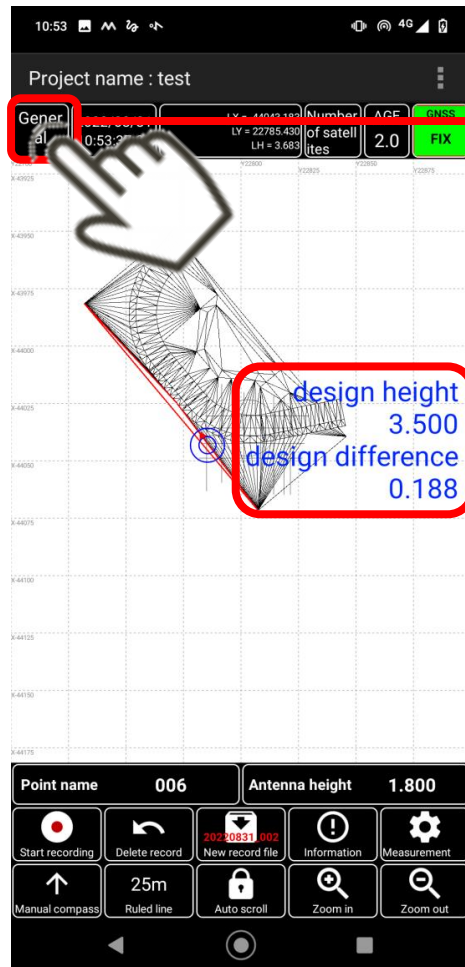

Tap the upper left of the screen.

Measurement mode
General single-point

When the LandXML file is imported and shown, the **design height** and **design difference** are listed in any measurement mode.

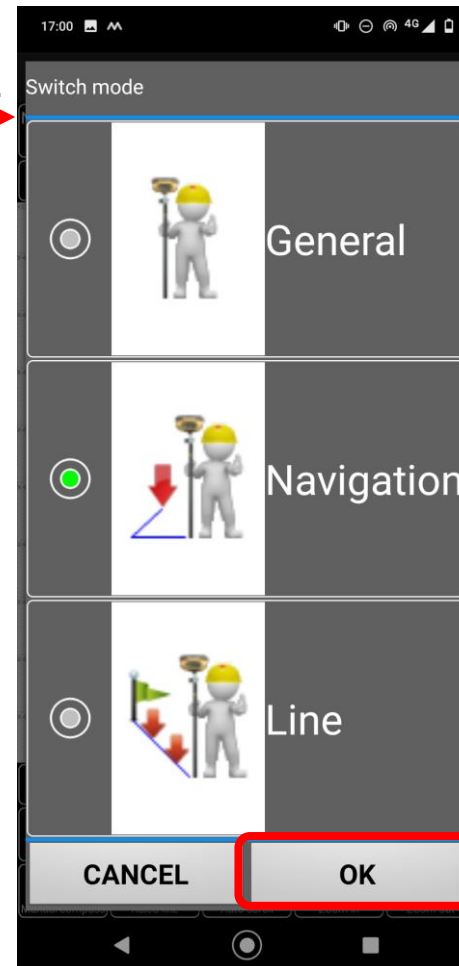

Select the measurement mode, and tap [OK].

8-1. Importing and displaying design data (LandXML) files

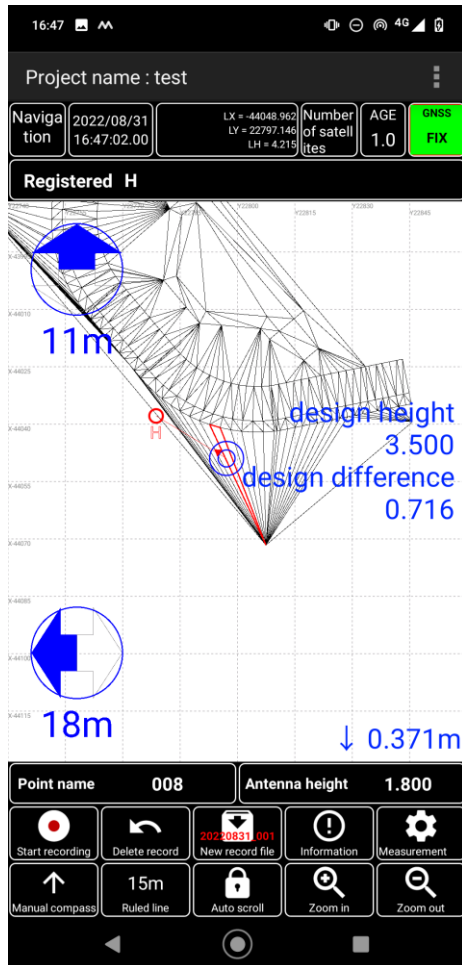

Example)
Measurement mode
**Reversed placing
single-point**

Chapter 9

Actual Measurement

Make actual measurements in each measurement mode.

9-1. General single-point measurement (or Point Measurement)

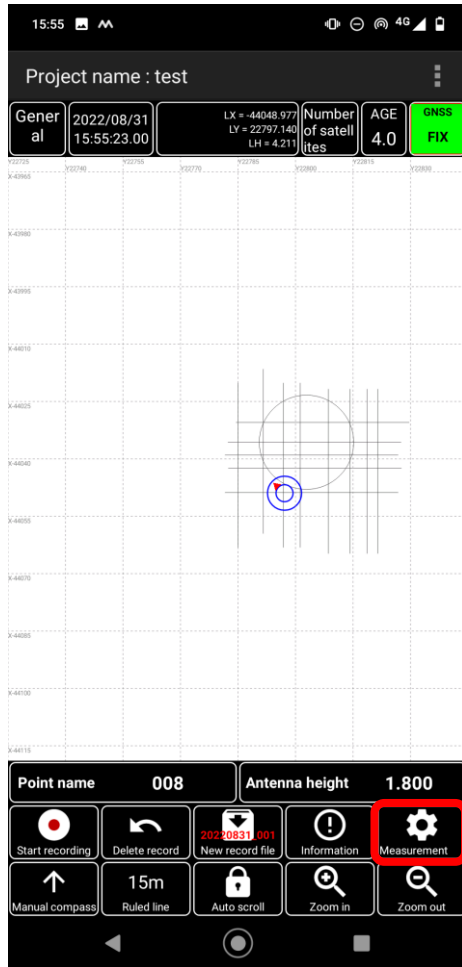

Tap [Measurement].

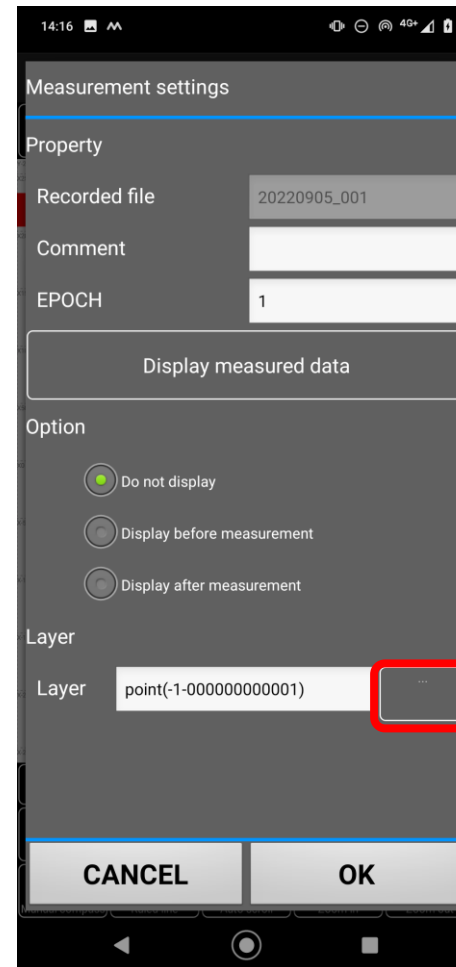

Tap  next to the [Layer] box.

9-1. General single-point measurement (or Point Measurement)

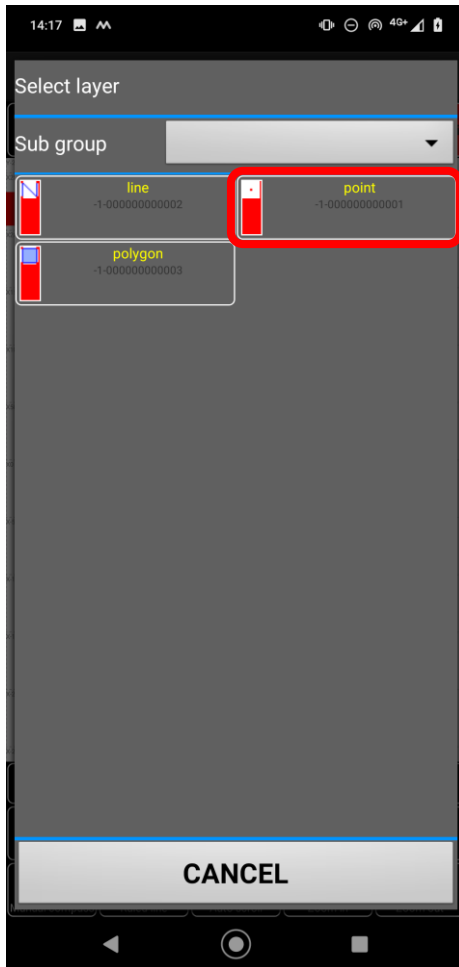

Tap **[point]**.

Normally select **[point]**. However, **[line]** or **[polygon]** can also be used for measurement.

- **[line]**:
For **length** measurement.

- **[polygon]**:
For **area** measurement.

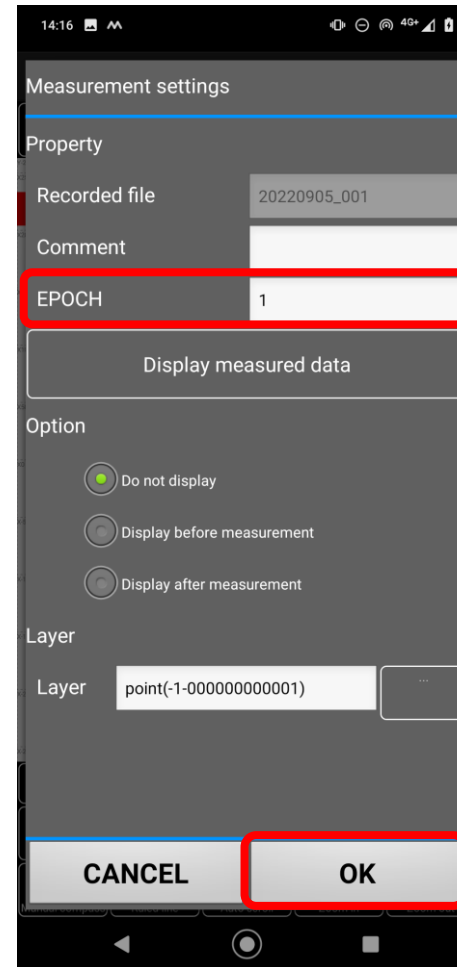

[EPOCH] specifies the number of data items to average during measurement.

[SC Rover] usually outputs 1 Hz (once per second) data; for example, if you set it to [3], the data for 3 s will be averaged.

* **Irrelevant when the localization is performed.**

Tap **[OK]**.

9-1. General single-point measurement (or Point Measurement)

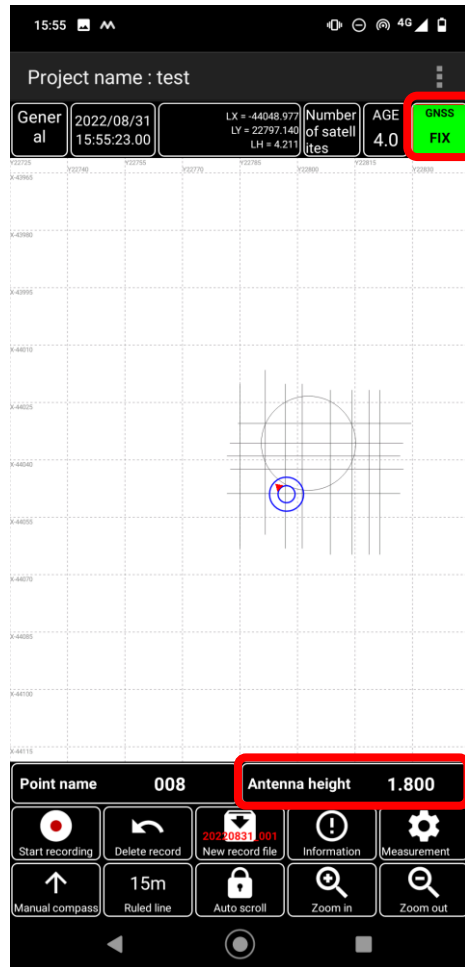

Confirm that GNSS is **[FIX]**.

Also, check that the **[Antenna height]** indicates the height of the pole to measure.

The phase center height of the antenna [AR270] used in pair with the SC Rover is taken into consideration. Thus, enter the pole height.

* See "4-3. Inputting the antenna height".

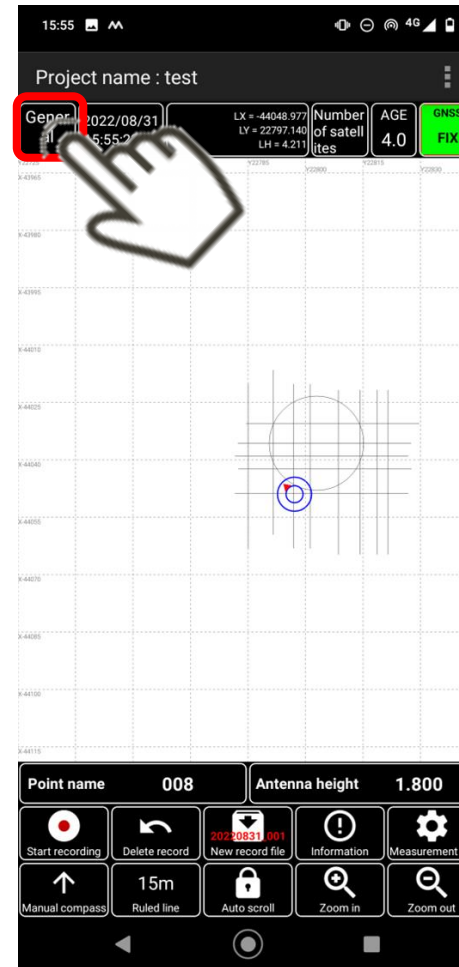

Select the **measurement method**.

Tap the upper left of the screen.

9-1. General single-point measurement (or Point Measurement)

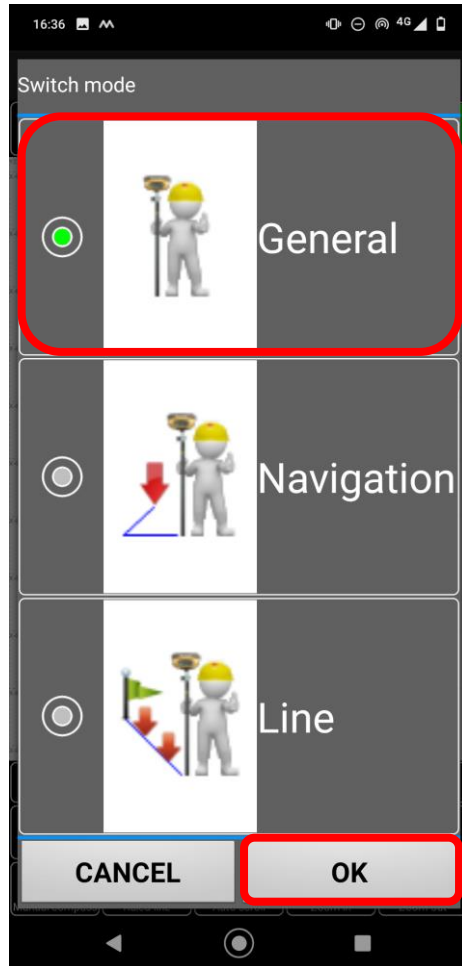

Tap [**General**] and then [OK].

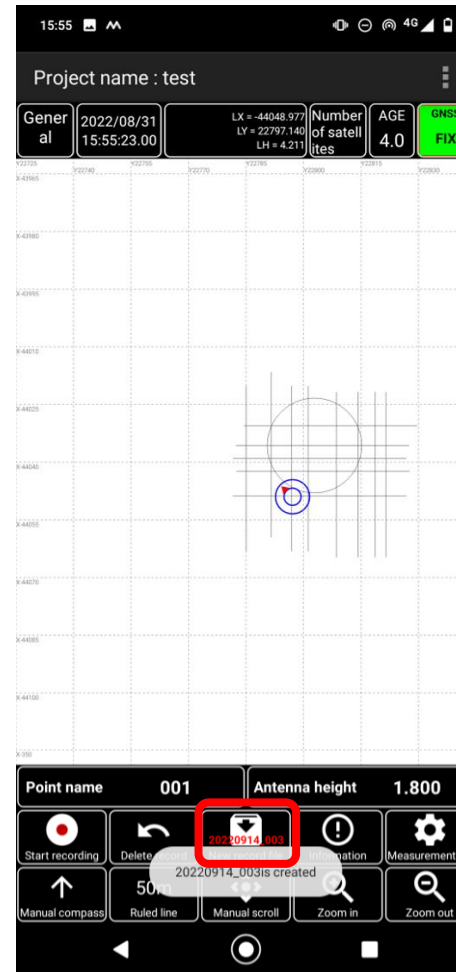

Tap [**New measurement file**] to create a new measurement file.
The file name is automatically created in the format of "date_sequence number" (e.g. 20200519_001).

For example, if you continuously perform single-point measurement without creating a new file, the results of single-point measurement will be saved in the same file name until you create a new file.

* For example, multiple measured points are saved in a file named "20200519_001".
→ **This does not mean that the measurement results will be lost.**

For single-point measurement, tap [Record file] for each single-point measurement to make the save destination file different for each measurement point.

To make measurements on different layers (lines/faces), tap [New record file] to create it.
→ **Even without creating a new one, the measurement results will not be lost.**

9-1. General single-point measurement (or Point Measurement)

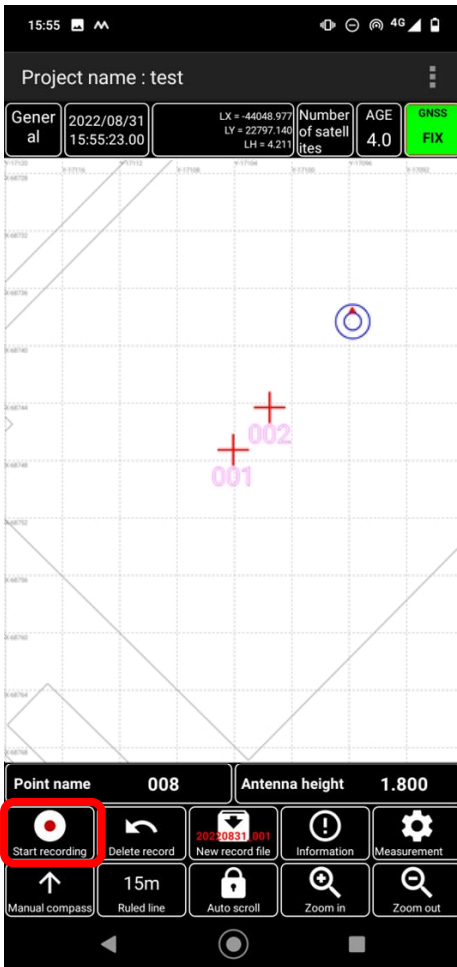

With the antenna fixed at the measurement location, tap **[Start recording]**.

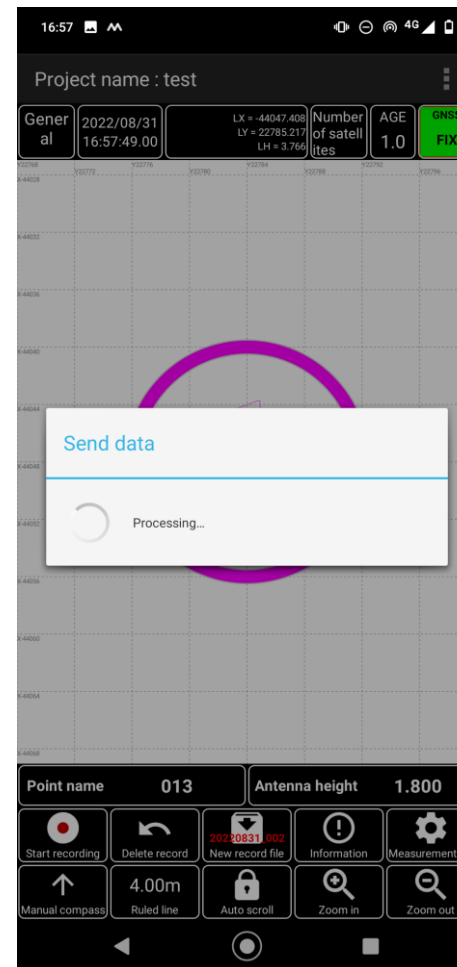

When the [EPOCH] value set in [Measurement settings] is reached, the measurement automatically ends and the data is sent.

9-1. General single-point measurement (or Point Measurement)

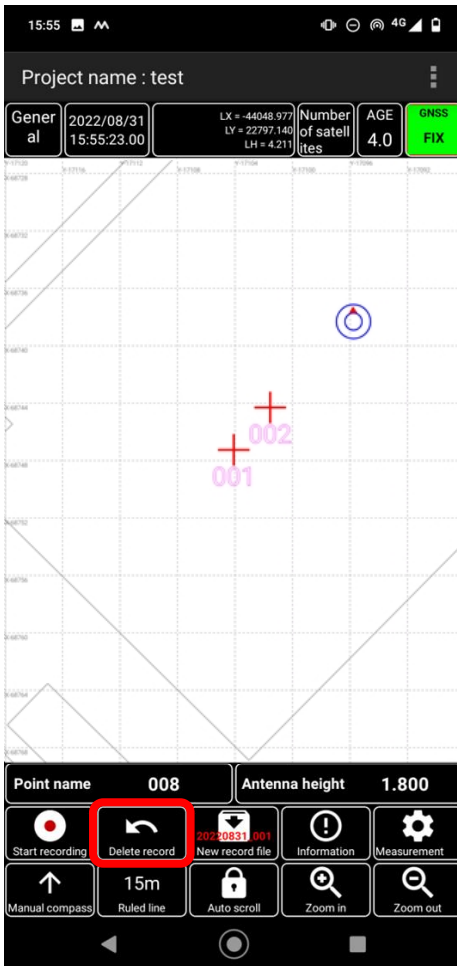



Make measurements in order.

* To delete the measurement result of the currently measured point and remeasure it, tap **[Delete record]** before starting the re-measurement.

9-2. Reversed placing single-point measurement (guiding it to the reversed placing point before Point Measurement)

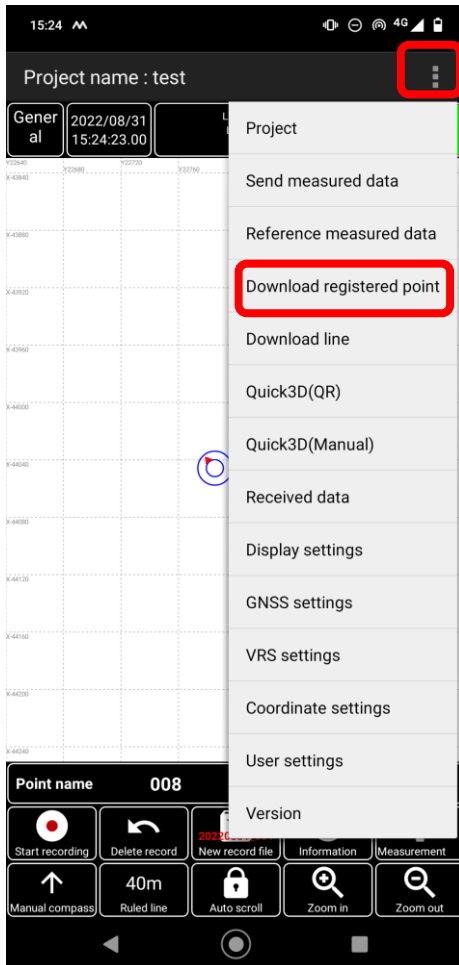
Register the reversed placing point



Tap the menu  and then **[Download registered point]**.



Registering the known points is by manual input. Manual input can be done by tapping [ADD].

To do manual input, tap [ADD].

9-2. Reversed placing single-point measurement (guiding it to the reversed placing point before Point Measurement)

Register the reversed placing point

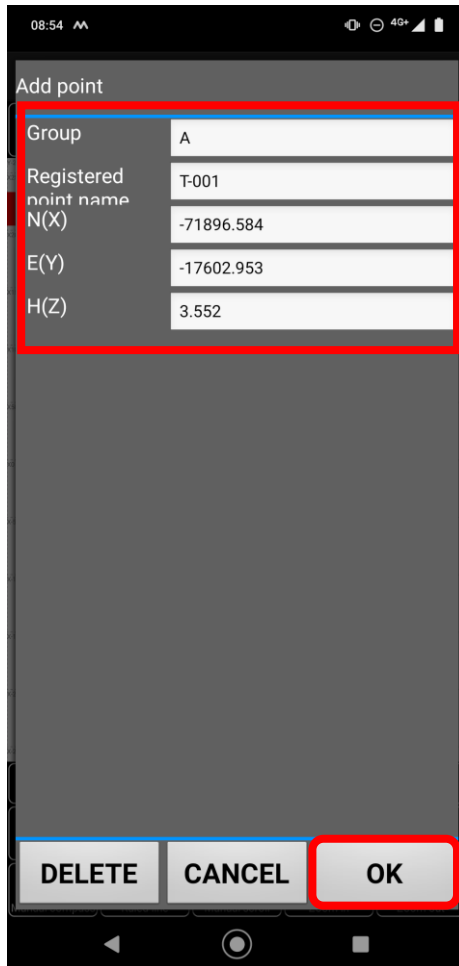

08:54

Add point

Group	A
Registered point name N(X)	T-001
E(Y)	-71896.584
H(Z)	-17602.953

DELETE CANCEL OK

- **Group:**
Enter the name.
* Any name is accepted.
Designed so that it can be registered for each category for easy selection.
- **Known point name:**
Enter the **known point name** of the desired target point of reversed placing.
 - **N(X)**
 - **E(Y)**
 - **H(Z)**Enter the **X**, **Y**, and **H** values.

After confirming the entered values, tap [OK].

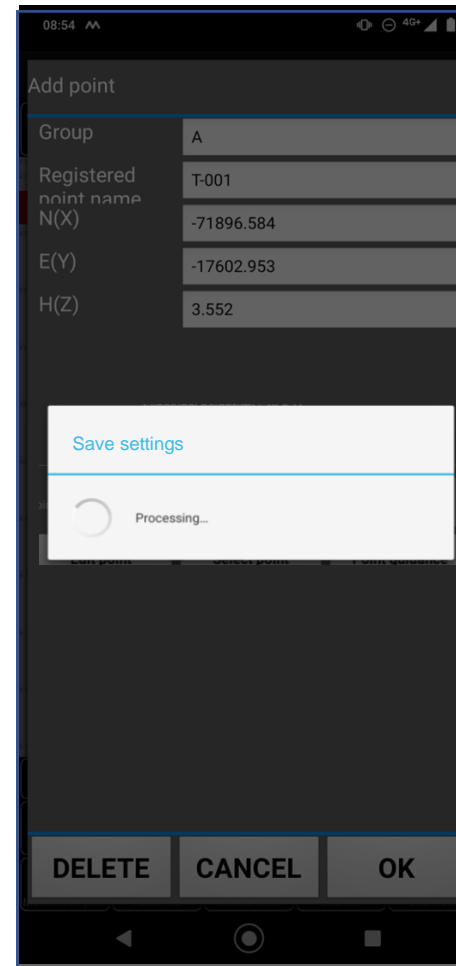

08:54

Add point

Group	A
Registered point name N(X)	T-001
E(Y)	-71896.584
H(Z)	-17602.953

Save settings

Processing...

DELETE CANCEL OK

The input point is saved.

9-2. Reversed placing single-point measurement (guiding it to the reversed placing point before Point Measurement)

Register the reversed placing point



If you want to continue to enter, tap **[ADD]** and enter it the same way.

After completing the input, tap **[CLOSE]**.

9-2. Reversed placing single-point measurement (guiding it to the reversed placing point before Point Measurement)

Perform reverse placing single-point measurement

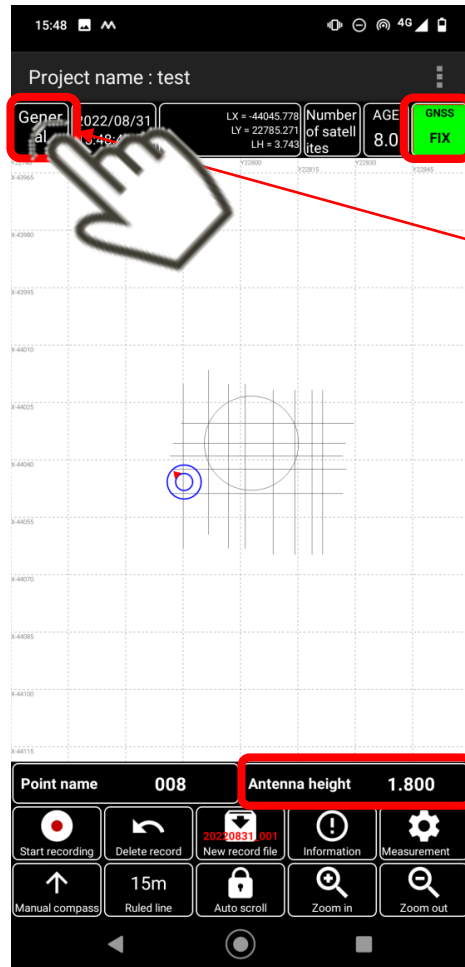

Select the **measurement method**.

Tap the upper left part of the left screen.

Confirm that GNSS is **[FIX]**.

Also, check that the **[Antenna height]** indicates the height of the pole to measure.

The phase center height of the antenna [AR270] used in pair with the SC Rover is taken into consideration. Thus, enter the pole height.

*** See "4-3. Inputting the antenna height".**

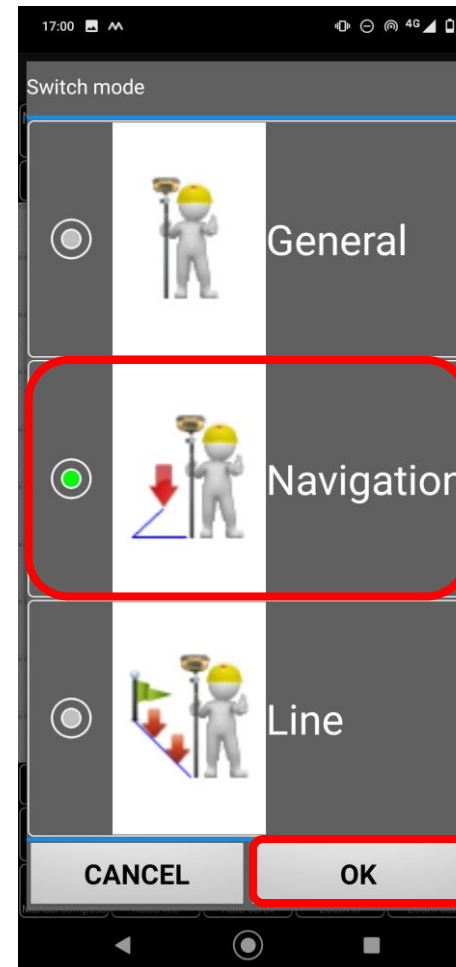

Tap **[Navigation]** and then **[OK]**.

9-2. Reversed placing single-point measurement (guiding it to the reversed placing point before Point Measurement)

Perform reverse placing single-point measurement

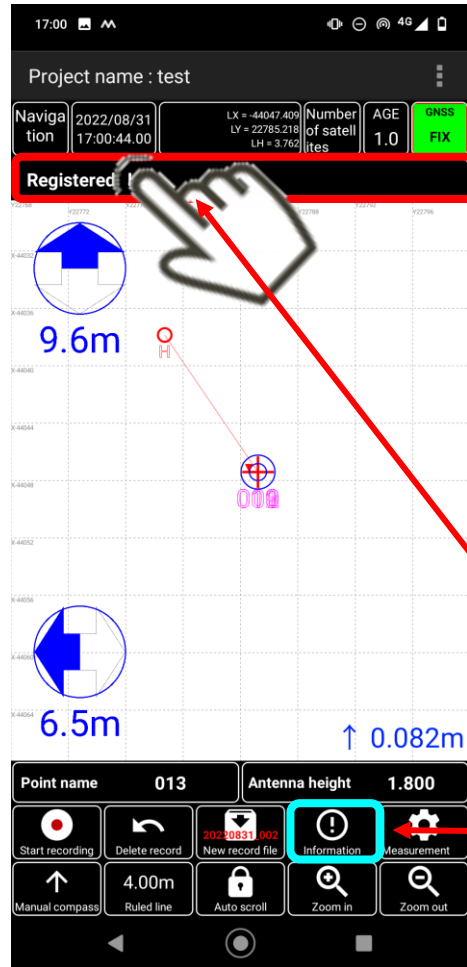

Select the reverse placing point.

Tap **[Registered]** at the upper part of the screen.

* If the **[Registered]** selection bar is not shown, at the lower part of the screen, tap the **[Information]** button to show it.

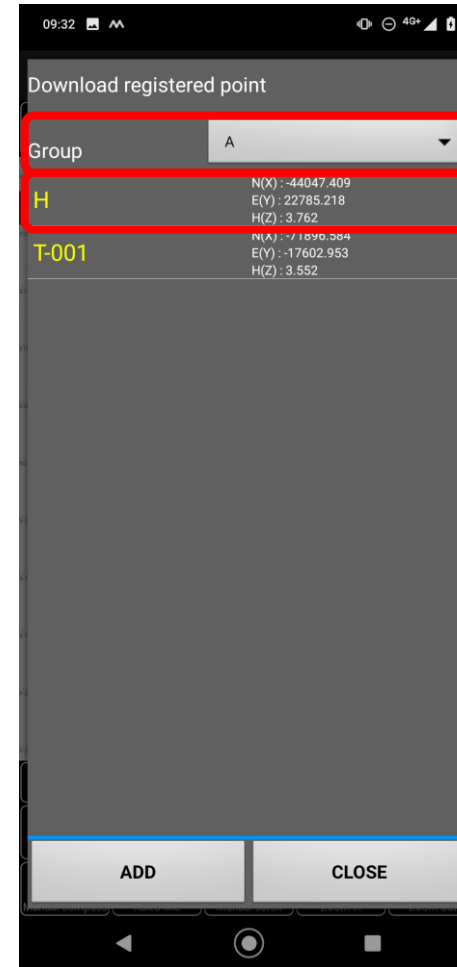

Tap **[Group]** and tap the target **point** of reverse placing measurement.

9-2. Reversed placing single-point measurement (guiding it to the reversed placing point before Point Measurement)

Perform reverse placing single-point measurement

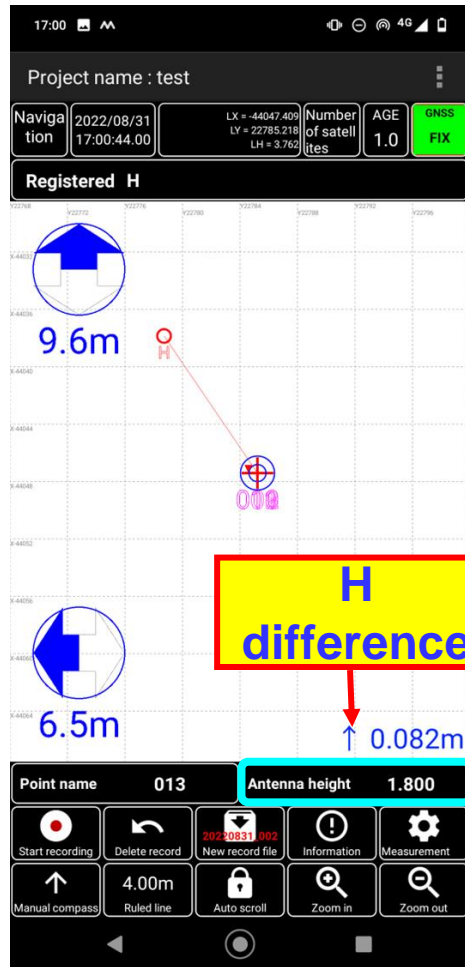

The **deviation amount** between the selected **reversed placing point** and the **current position** is displayed.

Check that [**Antenna height**] indicates the height of the pole to measure.

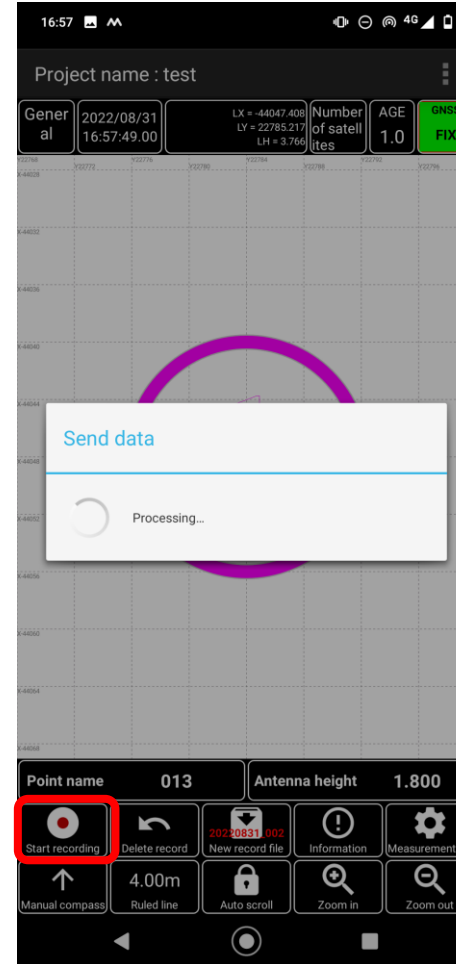

Guide it to the reversed placing point and perform the measurement.

The measurement method is the same as "9-1. **General single-point measurement**".

With the antenna fixed at the measurement location, tap [**Start recording**].

* For a regolith contract, the measured data will be sent to the server.

9-3. Survey line single-point measurement (guiding it onto the survey line before Point Measurement)

Register the survey line

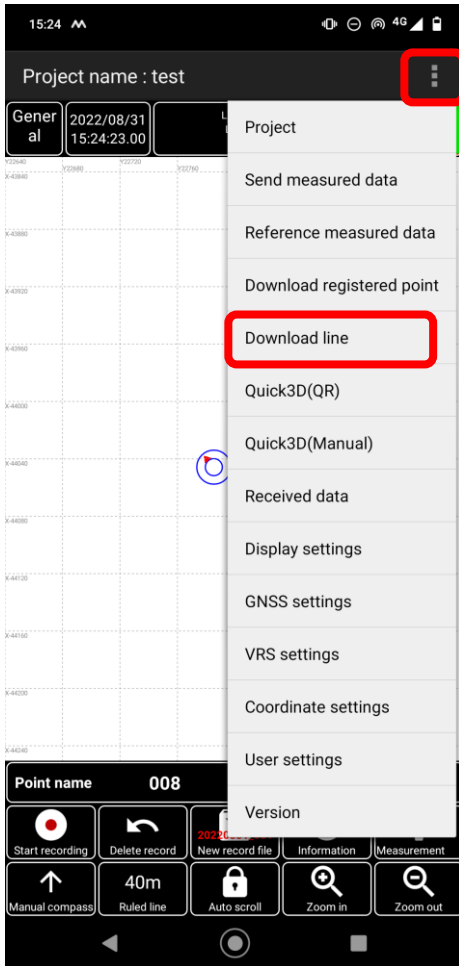

Tap the menu  and then **[Download line]**.



Registering the survey line is by manual input. Manual input can be done by tapping [ADD].

To do manual input, tap [ADD].

9-3. Survey line single-point measurement (guiding it onto the survey line before Point Measurement)

Register the survey line

10:29

Add line

Group	A	
Line name	A-1	
N(X)	-68820	Start point
E(Y)	-17160	
H(Z)	0	
N(X)	-68720	End point
E(Y)	-17160	
H(Z)	0	

DELETE CANCEL OK

- **Group:**
Enter the name.
* Any name is accepted.
Designed so that it can be registered for each category for easy selection.
 - **Line name:**
Enter the survey line name.
Enter the point coordinates of the two endpoints (start and end points) of the survey line.
 - N(X)
 - E(Y)
 - H(Z)Enter the X, Y, and H values.
* **Enter 0 for H.**
The height difference is not shown during measurement.
- After confirming the entered values, tap [OK].

10:31

Download line

Group A

A-1

N(X)	-68820.000
E(Y)	-17160.000
H(Z)	0.000
N(X)	-68720.000
E(Y)	-17160.000
H(Z)	0.000

ADD CLOSE

The input point is saved.

If you want to continue to enter, tap [ADD] and enter it the same way.

After completing the input, tap [CLOSE].

9-3. Survey line single-point measurement (guiding it onto the survey line before Point Measurement)

Perform survey line single-point measurement

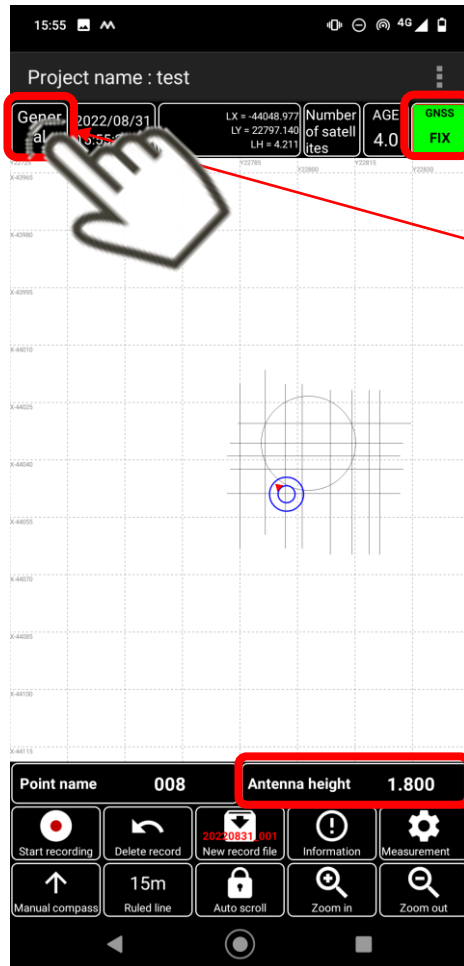

Select the **measurement method**.

Tap the upper left part of the left screen.

Confirm that GNSS is **[FIX]**.

Also, check that the **[Antenna height]** indicates the height of the pole to measure.

The phase center height of the antenna [AR270] used in pair with the SC Rover is taken into consideration. Thus, enter the pole height.

*** See "4-3. Inputting the antenna height".**

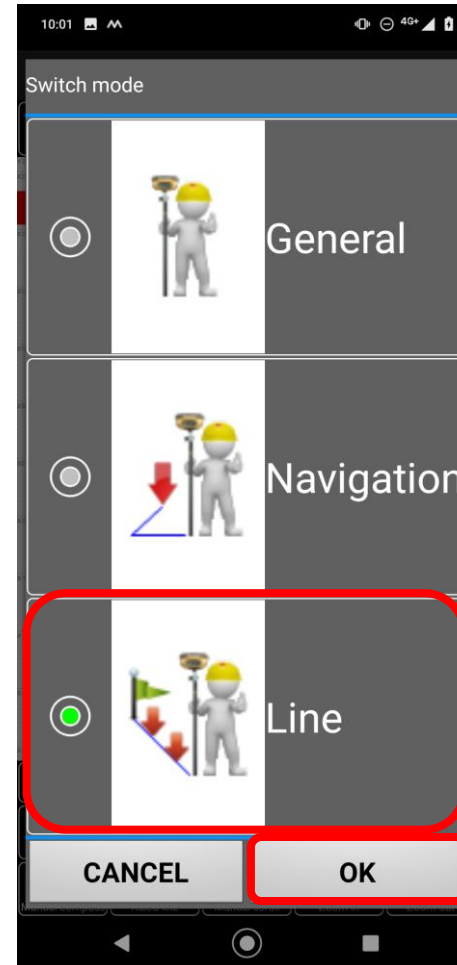

Tap **[Line]** and then **[OK]**.

9-3. Survey line single-point measurement (guiding it onto the survey line before Point Measurement)

Perform survey line single-point measurement

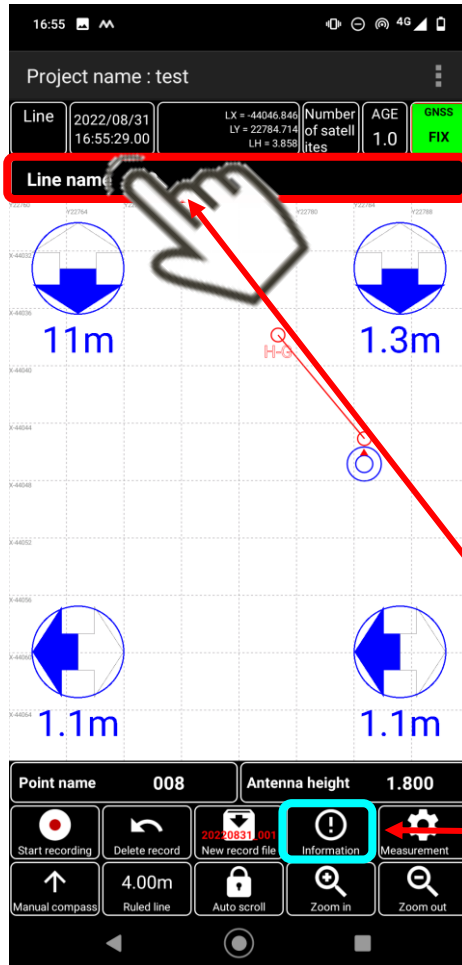

Select the reverse placing point.

Tap [**Line name**] at the upper part of the screen.

* If the [**Line name**] selection bar is not shown, at the lower part of the screen, tap the [**Information**] button to show it.

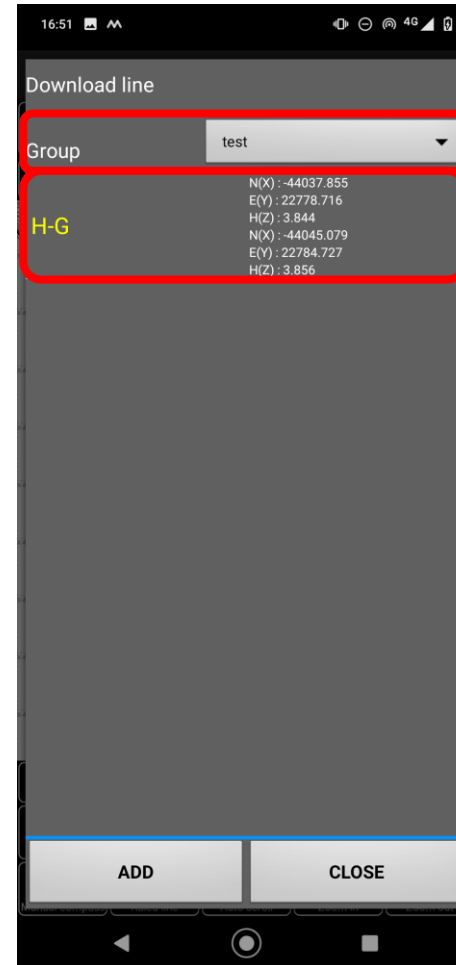

Tap [**Group**] and then the survey line to measure.

9-3. Survey line single-point measurement (guiding it onto the survey line before Point Measurement)

Perform survey line single-point measurement

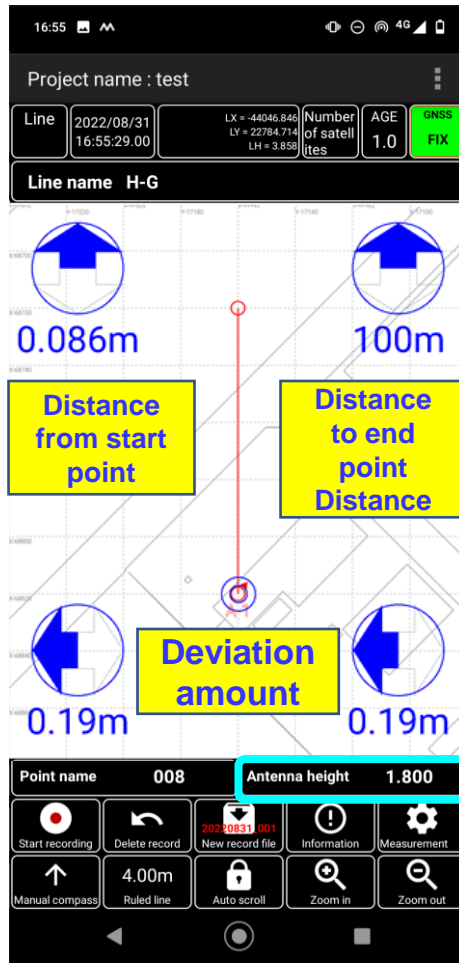

The **deviation amount** between the selected **survey line** and the **current position** is shown.

Check that [**Antenna height**] indicates the height of the pole to measure.

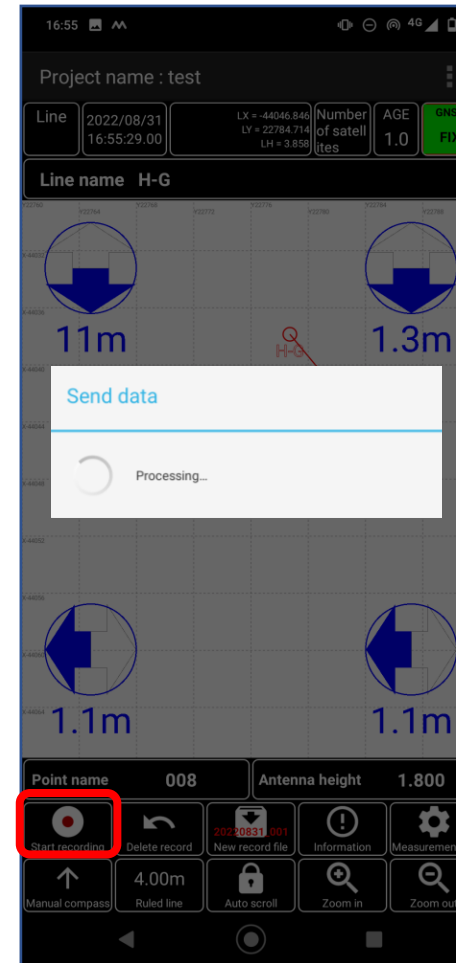

Guide it to the reversed placing point and perform the measurement. The measurement method is the same as "9-1. **General single-point measurement**".

With the antenna fixed at the measurement location, tap [**Start recording**].

Chapter 10

Measurement Point Position Checks

The coordinates of the measured data can be viewed on the terminal screen and be output as a CSV file.

10-1. Checking the measured points

Check the coordinates on the spot

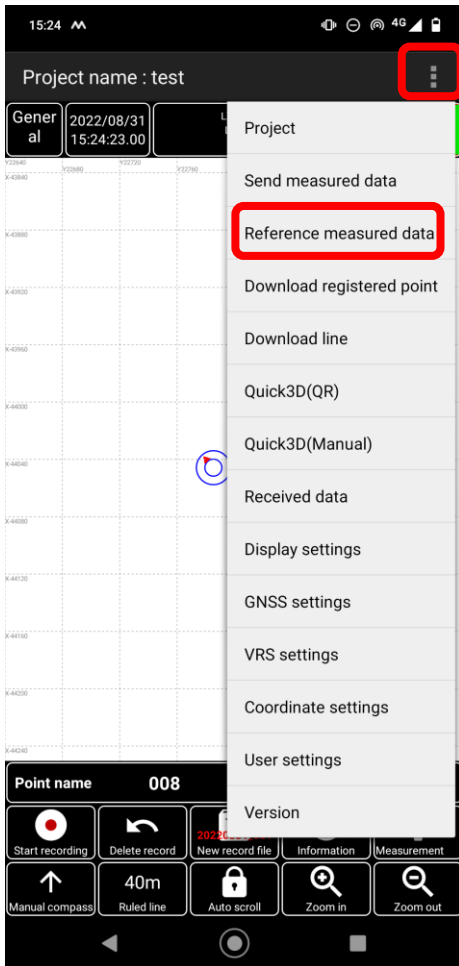

Tap the menu  and then [Reference measured data].

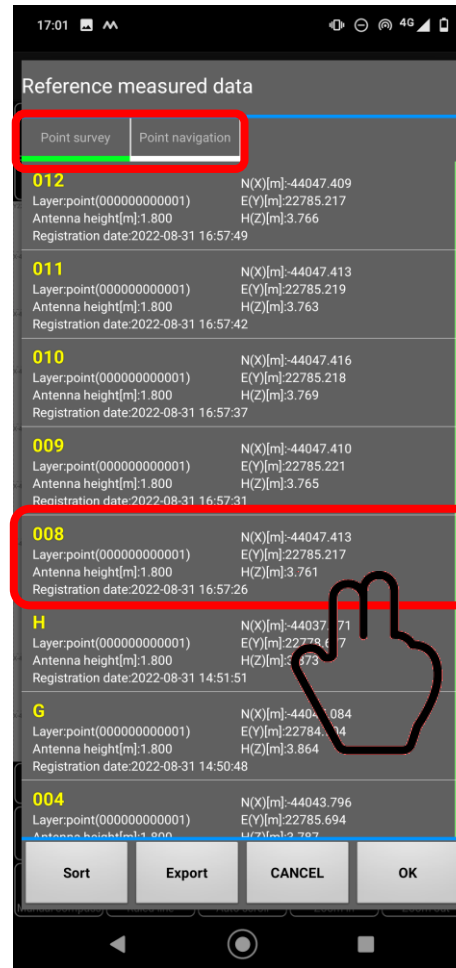

You can view the coordinates measured for each measurement mode of the top tabs.

You can view the details by tapping the desired item of measured data to be viewed.

10-1. Checking the measured points

Check the coordinates on the spot

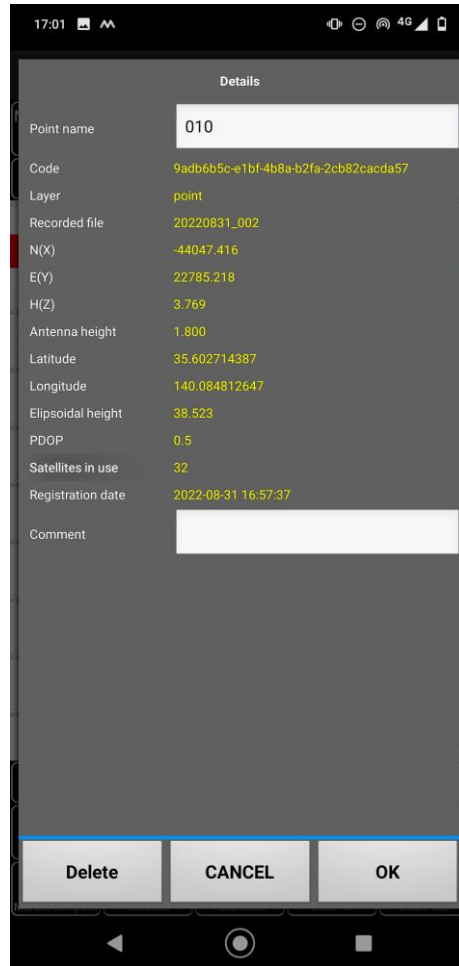



This screen lists the X, Y, H, latitude, longitude, and ellipsoidal height values of the measured data.

* **The latitude and longitude are expressed in deg.**

10-2. Exporting the measured points

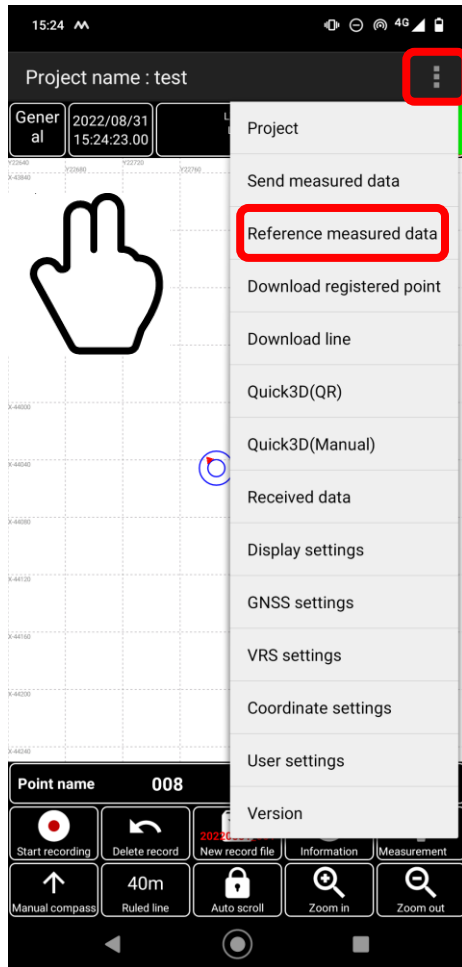
Check the coordinates on the spot



Tap the menu  and then **[Reference measured data]**.

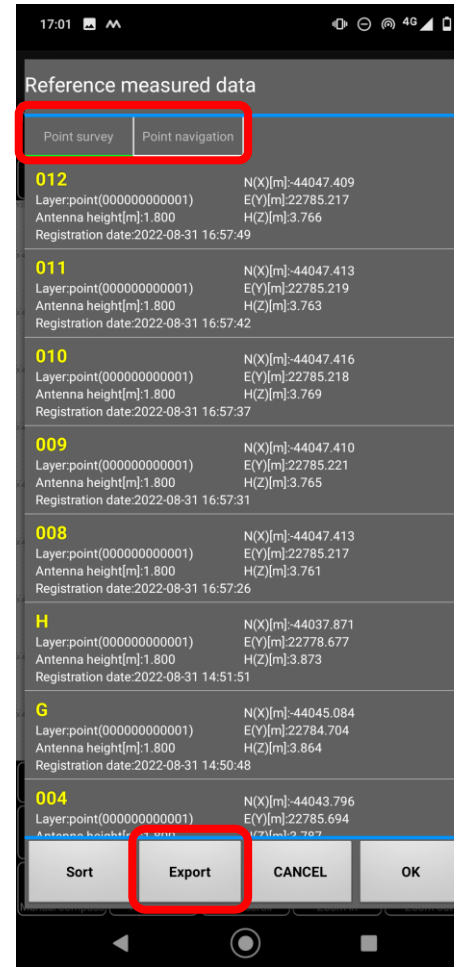

You can view the coordinates measured for each of the measurement modes on the top tabs.

To export the file, tap **[Export]**.
* The file will be exported into the terminal.

10-2. Exporting the measured points

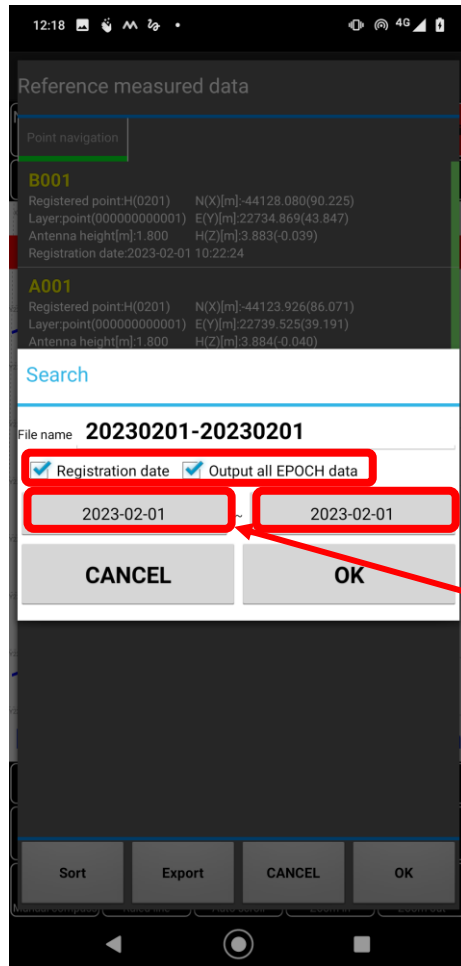

Tap [Registration date] to check it.

“Output all EPOCH data ”
Check if you want to output the averaged measurement coordinates in general.

Tap the date to specify the date range for file export.

Be sure to specify the date range.

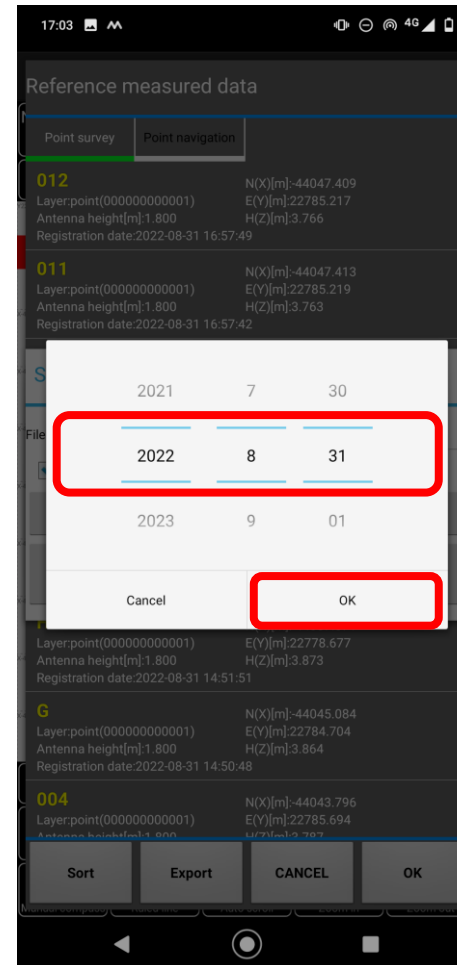

Specify the date and tap [OK]

If the data measured by General, Navigation, Line is within the date range, all data will be output.

10-2. Exporting the measured points

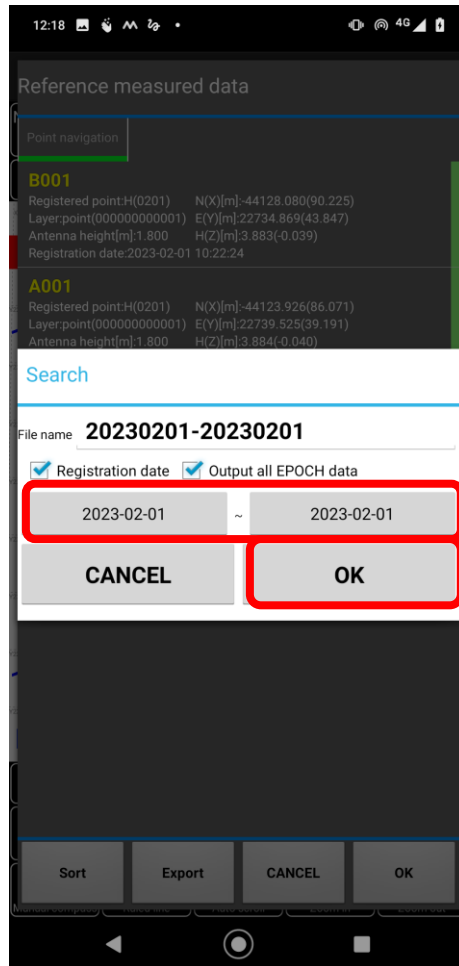

Check the specified date range and tap [OK].

Note

If the specified date range includes no measured data, an error will result.

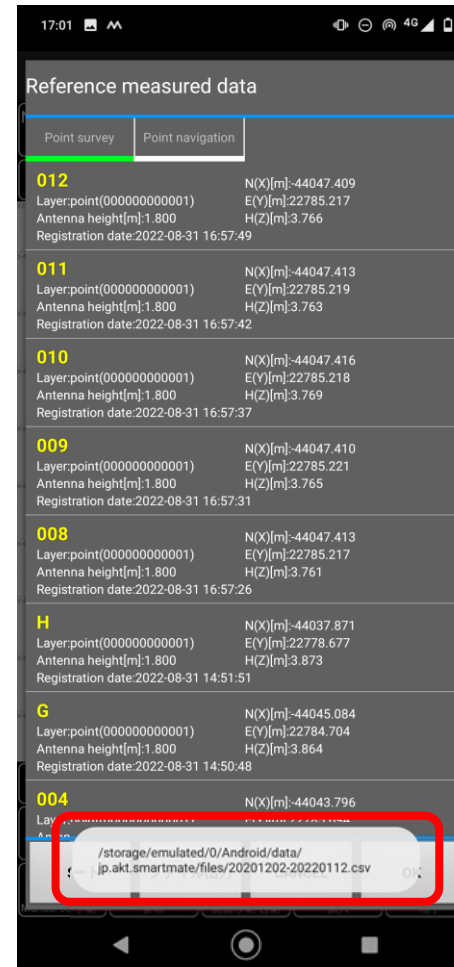

Folder in the terminal:Data is exported to **Internal Shared Storage/Android/data/ip.komatsu.SCROver/files** folder.

- * The file exported will be named [yyyymmdd-yyyymmdd.csv] (the specified export date).
- * **The export destination folder is unchangeable.**

Connect the terminal and PC. Then, transfer to the PC, the files exported in the terminal.

3-5-2-2.

See "(3) Copying and pasting the CSV file to the terminal".

10-2. Exporting the measured points

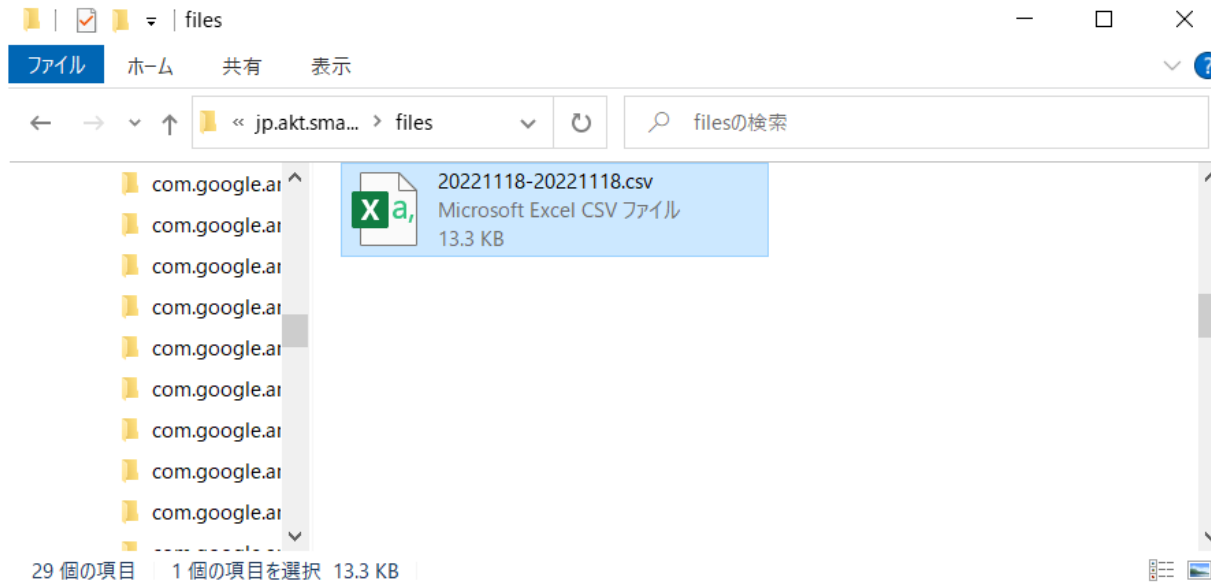

Folder in terminal
Internal shared storage
`/Android/data/ip.komatsu.SCRover/files`
The output will be in the above folder.
The name of the output file is "yyyymmdd-yyyymmdd.csv".
The name of the output file is "yyyymmdd-yyyymmdd.csv".

***The destination folder cannot be changed.**

Connect the device and a computer,
and transfer the files output to the
device to a computer, etc.

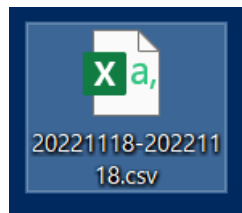

10-2. Exporting the measured points

The screenshot shows a software window with a menu bar and a toolbar. The 'File' menu is highlighted with a red box. Below the menu is a ribbon with various options. The main area is a data table with the following columns: Date & Time, Point name, X, Y, H, Latitude (degree), Longitude (degree), ellipsoid height, HDOP, Number of Satellites, and GPS solution used. The table contains data for multiple points, with rows 2 through 12 highlighted in red. A blue box labeled 'Measurement average value coordinates' points to the X, Y, and H values of the first highlighted row. A red box labeled 'Measurement coordinates used for average' covers the X, Y, and H values of the last highlighted row. A pink box contains the text: '※SC Rove(RTF500) =Number of satellites used' and '※CS Mate PRO =Common satellite number'. The 'Number of Satellites' column for the highlighted rows shows the value '31', and the 'GPS solution used' column shows '5'. A note '5=FIX' is also present. At the bottom, there is a text box: 'Example) Data output by checking "Output all EPOCH data "'.

Date & Time	Point name	X	Y	H	Latitude (degree)	Longitude (degree)	ellipsoid height	HDOP	Number of Satellites	GPS solution used
Date	Name	NX	EY	HZ	Lat	Lon	Elev	HDOP	UsedSat	Quantity
2022/11/18 17:13	T-1	-68823.44314	-17167.32958	10.613485	35.37949796	139.6443816	48.3827	0.62	31	5
2022/11/18 17:13		-68823.44157	-17167.32989	10.613185	35.37949798	139.6443816	48.3824	0.62	31	5
2022/11/18 17:13		-68823.44157	-17167.32989	10.613185	35.37949796	139.6443816	48.3874	0.62	31	5
2022/11/18 17:13		-68823.44157	-17167.32989	10.613185	35.37949796	139.6443816	48.3884	0.62	31	5
2022/11/18 17:13		-68823.44416	-17167.32823	10.615185	35.37949795	139.6443817	48.3844	0.62	31	5
2022/11/18 17:13		-68823.44601	-17167.32945	10.613185	35.37949794	139.6443816	48.3824	0.62	31	5
2022/11/18 17:13		-68823.44508	-17167.32899	10.607185	35.37949794	139.6443816	48.3764	0.62	31	5
2022/11/18 17:13		-68823.44028	-17167.32944	10.604185	35.37949799	139.6443816	48.3734	0.62	31	5
2022/11/18 17:13		-68823.44028	-17167.32944	10.604185	35.37949799	139.6443816	48.3804	0.62	31	5
2022/11/18 17:13		-68823.44028	-17167.32944	10.604185	35.37949799	139.6443816	48.3854	0.62	31	5
2022/11/18 17:13		-68823.44028	-17167.32944	10.604185	35.37949799	139.6443816	48.3864	0.62	31	5
2022/11/18 17:13	T-2	-68823.44434	-17167.33016	10.616684	35.37949795	139.6443816	48.3859	0.62	31	5
2022/11/18 17:13		-68823.44415	-17167.33247	10.609184	35.37949795	139.6443816	48.3784	0.62	31	5
2022/11/18 17:13		-68823.44397	-17167.33202	10.616184	35.37949795	139.6443816	48.3854	0.62	31	5
2022/11/18 17:13		-68823.44416	-17167.3296	10.615185	35.37949795	139.6443816	48.3844	0.62	31	5
2022/11/18 17:13		-68823.44416	-17167.32854	10.614185	35.37949795	139.6443816	48.3834	0.62	31	5

To save in Excel format, click [File].

10-2. Exporting the measured points



- ① Click "Save As"
- ↓
- ② Select the save destination
- ↓
- ③ Enter the file name
- ↓
- ④ Select the file format to save
Usually "Excel workbook (.xlsx)"
- ↓
- ⑤ Click "Save"

Chapter 11

Quick3D (GCP measurement)

Measure the ground control point (GCP) coordinates of Quick3D

Read the QR code of the GCP or enter the point name manually, and perform the measurement.

The [Quick3D] menu appears only when the project is linked to LANDLOG.

11-1. Measurement by reading the QR code

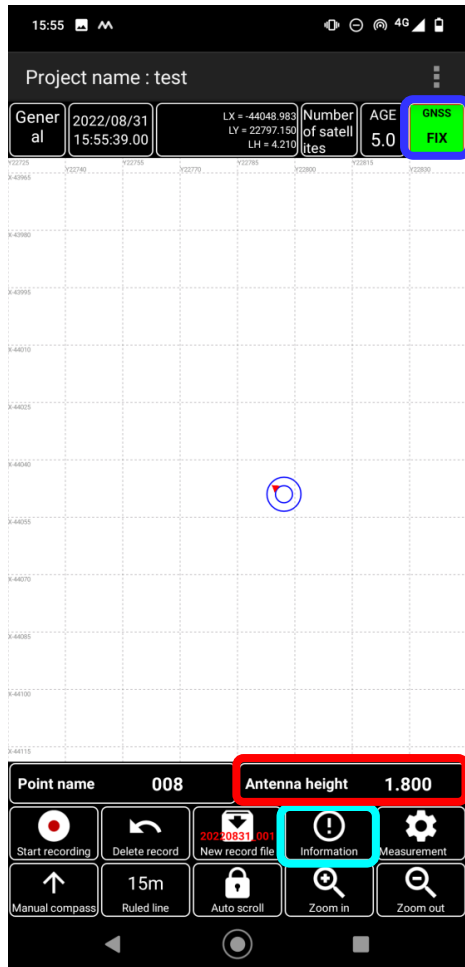

Confirm that it is **[FIX]**.

Check the antenna height under measurement.

Tap **[Antenna height]**.

* If **[Antenna height]** is not shown, at the lower part of the screen, tap the **[Information]** button to show it.

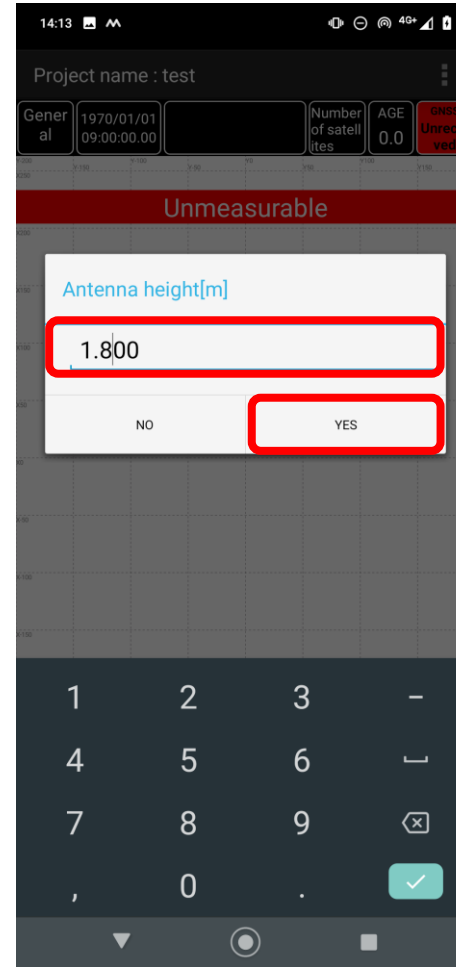

Enter the **[Antenna height]** for measurement and tap **[OK]**.

* If **[SC Rover]** is using an **[AR270]** antenna, the antenna phase center height is automatically taken into account in **[SC Rover App]**. Thus, all you have to do is to **enter the height of the pole to measure**.

11-1. Measurement by reading the QR code

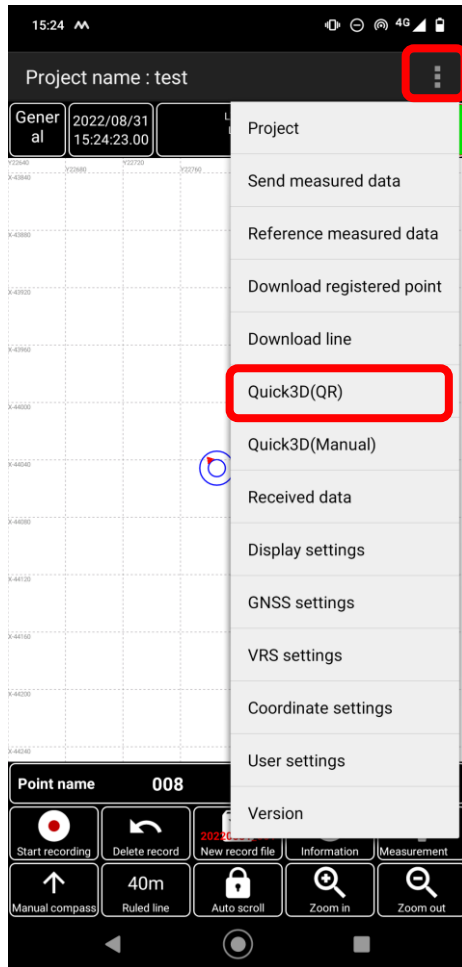

Tap the menu  and then **[Quick3D (QR)]**.

Note

The **[Quick3D]** menu appears only when the project is linked to **LANDLOG**.

See "3-2-2. Linking to a LANDLOG work".

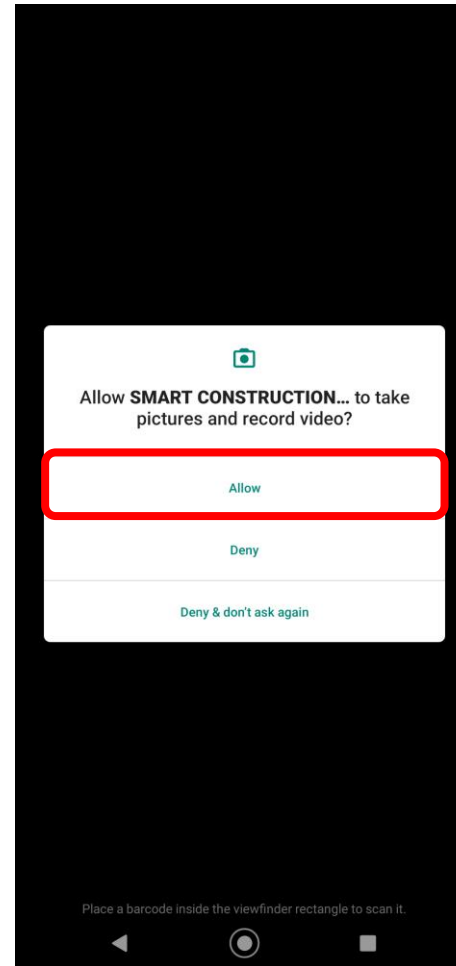

A permission confirmation is displayed only at the first time of use. Tap **[Allow]**.

11-1. Measurement by reading the QR code



The QR code reading screen starts up. Hold the smartphone over the QR code on the GCP sheet to read the point name.

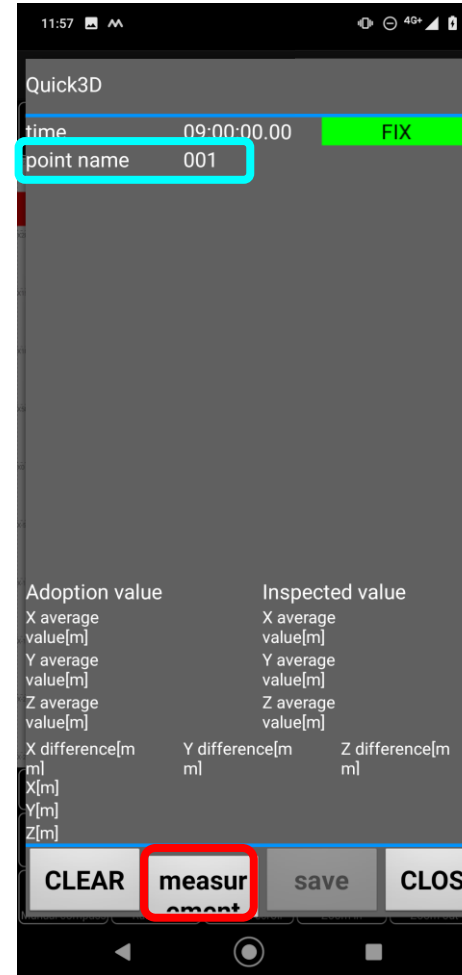

Fix the GNSS antenna horizontally at the measurement position of GCP and tap [measurement].

11-1. Measurement by reading the QR code

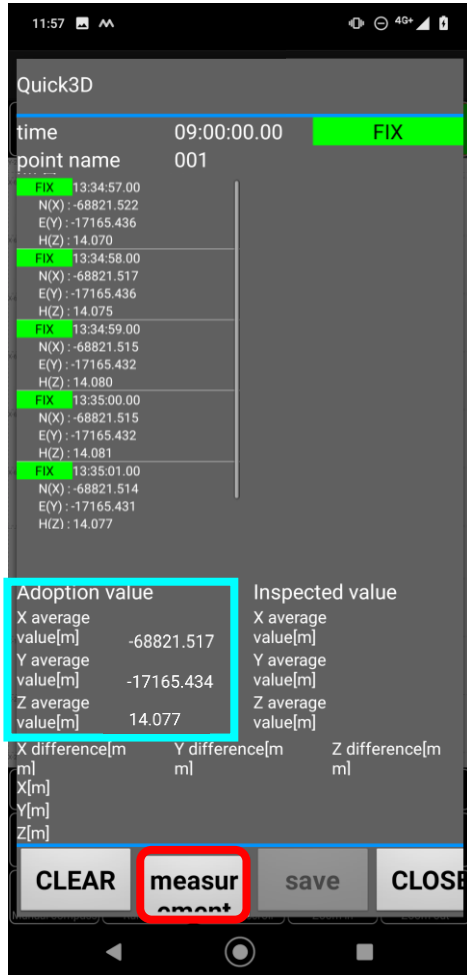

The average values of 10 epochs are listed in the **adoption value** section.

Tap **[measurement]** again to perform the measurement of the **inspected values**.

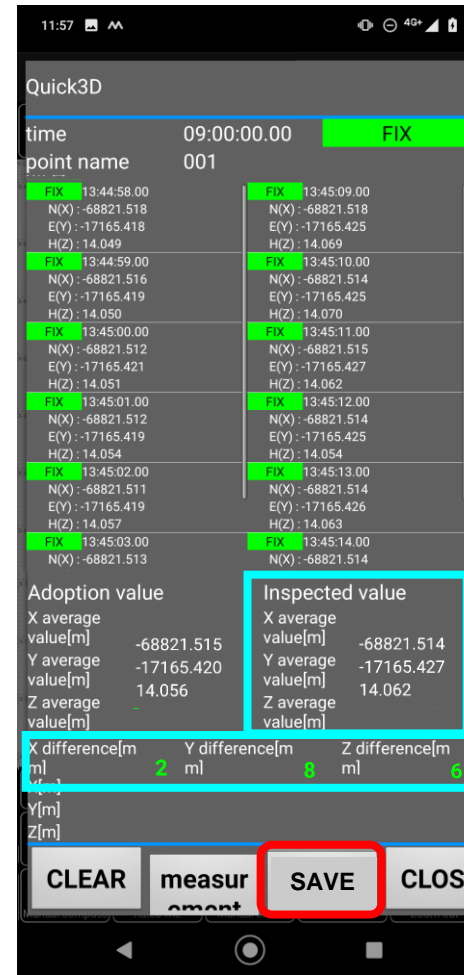

The average values of 10 epochs of the **inspected values** are listed, and the **differences between the adoption and inspected values** are listed.

When the difference between the adoption and inspected values is **in the specified range**, **[Save]** is enabled. Tap it to send the measured data to the server.

* The coordinate values sent are **adoption values**.

* Specified range
X and Y differences: ≤ 20 mm
Z difference: ≤ 30 mm

* **For re-measurement, see the next page.**

11-1. Measurement by reading the QR code

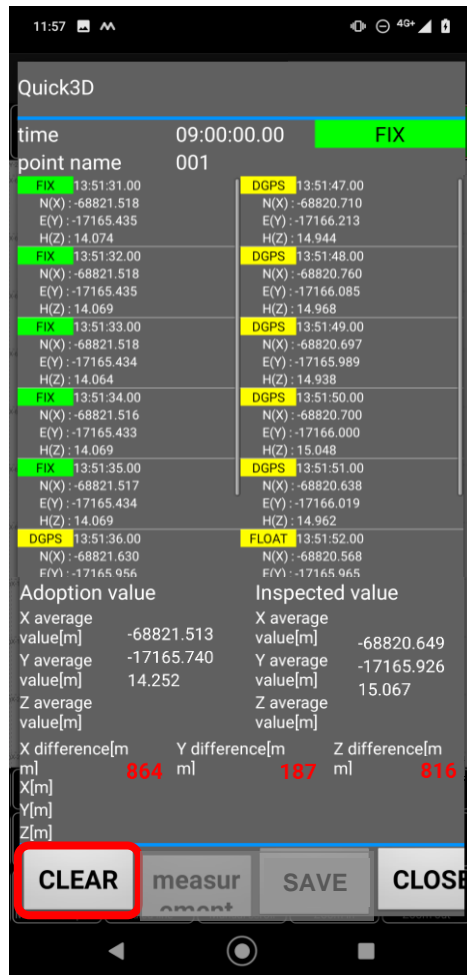

If the measurement result is out of the specified range, tap **[CLEAR]** and perform the re-measurement.

* Inspected values are cleared by tapping **[CLEAR]** in the [Inspected value] section. Tapping **[CLEAR]** again clears adoption values.

11-2. Measuring the ground control points (GCPs) manually

If the QR code on the GCP sheet cannot be read

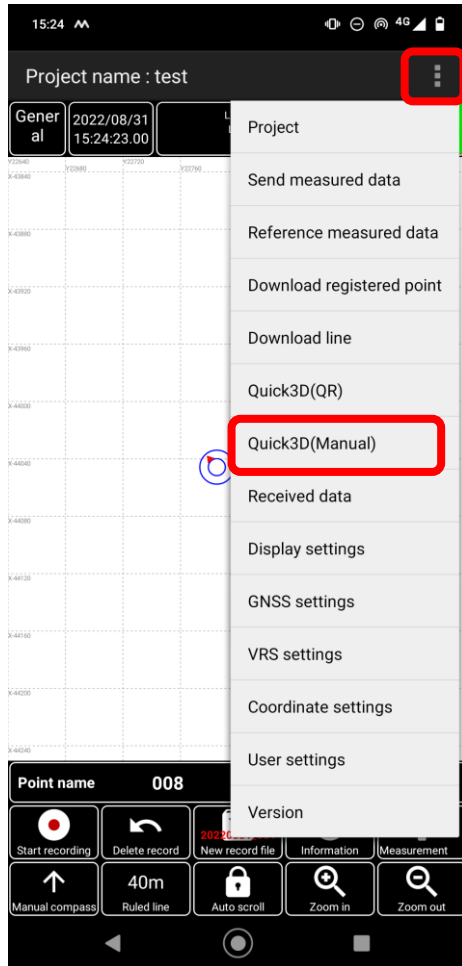

If the QR code on the GCP sheet cannot be read

Tap the menu  and then [Quick3D (Manual)].

Note
The [Quick3D] menu appears only when the project is linked to LANDLOG.

See "3-2-2. Linking to a LANDLOG work".

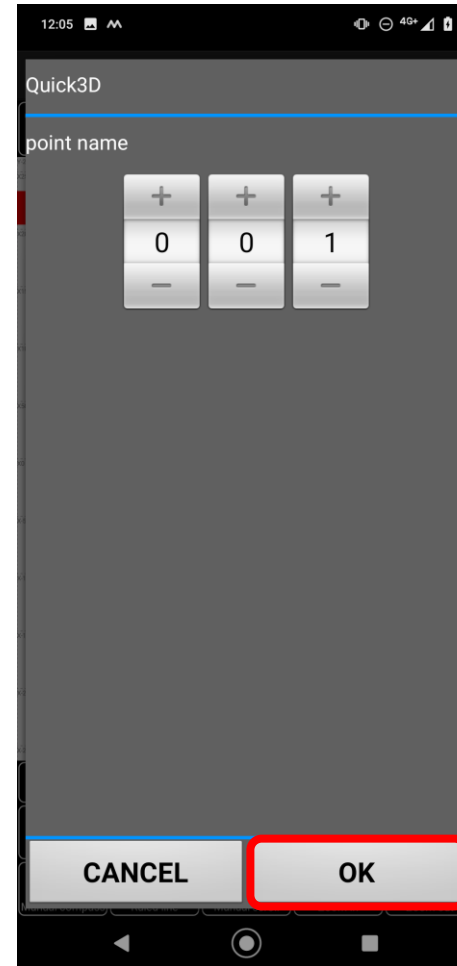

Manually enter the point name on the GCP sheet and tap [OK].

After that, the measurement method is the same as "11-1. Measurement by reading the QR code".

Contact information



EARTHRAIN Ltd.

You can contact support via the following site:

<https://support.smartconstruction.com/hc/en-us/requests/new>