

**GNSS RECEIVER "SC Rover"  
Configuration Application**

**RTFSetting  
Manual**

**Application Ver.000010 or later**

**November 1, 2022**

**Sales**



**EARTHBRAIN**

**Manufacturing**

**AKASAKATEC INC.**

**AKT**

# Contents

About Chapter 1 "RTFStetting" .....	5
1-1. About "RTFSetting" .....	6
Chapter 2 "RTFStetting" Installation .....	7
2-1. "RTFSetting" Installation .....	8
Chapter 3 "RTFStetting" Version Up .....	13
3-1. "RTFSetting" Version Up .....	14
About Chapter 4 About the "SC Rover" .....	21
4-1. About the "SC Rover" Specification .....	22
4-2. "SC Rover" internal switch (back side of receiver: inside the battery case) .....	23
4-3. "SC Rover" Start and Stop .....	24
Chapter 5 Wi-Fi connection for "SC Rover" and "Android device" .....	25
5-1. Wi-Fi connection for "SC Rover" and "Android device" .....	26

# Contents

<b>Chapter 6 "SC Rover" Firmware Update</b>	<b>32</b>
6-1. "SC Rover" Firmware Update...	33
<b>Chapter 7 "SC Rover" Connection Specification</b>	<b>35</b>
7-1. "SC Rover" Cable Specifications	36
7-2. The usual use of "SC Rover" and "SmartMate" (Ntrip)	
Using "SC Rover" as a rover with network RTK-GNSS (free choice of connection point)	37
7-3. RTK-GNSS using "external radio" with base station "SC Rover"	
Using "SmartMate" with the rover "SC Rover"	38
7-4. RTK-GNSS using "external radio" with base station "SC Rover"	
Using "retrofit kit, iMC Machine Type 11" as a rover	39
7-5. RTK-GNSS using "Komatsu Ntrip Caster" with base station "SC Rover"	
Using "SmartMate" with the rover "SC Rover"	40
7-6. . RTK-GNSS using "Komatsu Ntrip Caster" with base station "SC Rover"	
Using "retrofit kit, iMC Machine Type 11" as a rover	41
<b>Chapter 8 "SC Rover" base station installation recommended specifications</b>	<b>42</b>
8-1. "SC Rover" base station installation recommended specifications	43

# Contents

<b>Chapter 9 "SC Rover" Setup Preparation</b>	<b>45</b>
9-1. "SC Rover" Setup Preparation	46
<b>Chapter 10 "SC Rover" Setup</b>	<b>53</b>
10-1. Base station setup	54
10-1-1. "SC Rover" base station RTK Correction Data	55
10-1-2. "SC Rover" base station settings	56
10-1-3. Pre-registration of base station coordinates	58
10-1-4-1. Using an "external radio" with the base station	73
10-1-4-2. Using the "Komatsu Ntrip Caster" with the base station	85
10-2. Rover Setup	104
10-2-1. "SC Rover" rover RTK reception correction data	105
10-2-2. "SC Rover" rover settings	106
10-2-3-1. Using "SmartMate" with "Ntrip" method at rover	108
10-2-3-2. Using an "external radio" with the rover	116
10-2-3-3. Using the "Komatsu Ntrip Caster" with the rover	123

# Contents

Chapter11 Simple Measurement of base station Coordinates	131
11-1. Simple measurement of base station coordinates	132
11-2. Simple measurement setup of base station coordinates	133

# Chapter 1

## About the RTFSetting

# 1-1. About "RTFSetting"

■ GNSS receiver [RTF500(SC Rover)] [CSMate PRO] This application is dedicated for setting up.

※ Configure settings for the base station and rover.

■ This application is for Android terminals only.

■ It may not be available depending on the model and OS version of the Android terminal.

※ If you want to display the character display correctly on a usable terminal, you need to set the character size and display size on the Android terminal.

■ You can download it from "Google Play".

※ If the Play store version is older, you may not be able to download it. (Please update the Play Store to the latest version)

■ GNSS receiver [SC Rover] can be configured with Wi-Fi or Bluetooth communication connection.

▣ **Configure with a Wi-Fi connection. (Using a Bluetooth communication connection is a special case.)**

※ You can configure the Wi-Fi connection

"RTFSetting" Application Version - 000003 or higher (as of November 2022 - 000010)

"RTF500(SC Rover)" Firmware Version: 1.1.5 or Higher (as of November 2022:1.3.0.)

▣ When configuring with a Wi-Fi connection, you must configure the access point of your Android device.

■ The GNSS receiver [CS Mate PRO] is configured with a Bluetooth communication connection. (no pairing or other settings)

# Chapter 2

## "RTFSetting" Installation



## 2-1. "RTFSetting" Installation

When installing "RTFSetting" for the first time or after uninstalling it

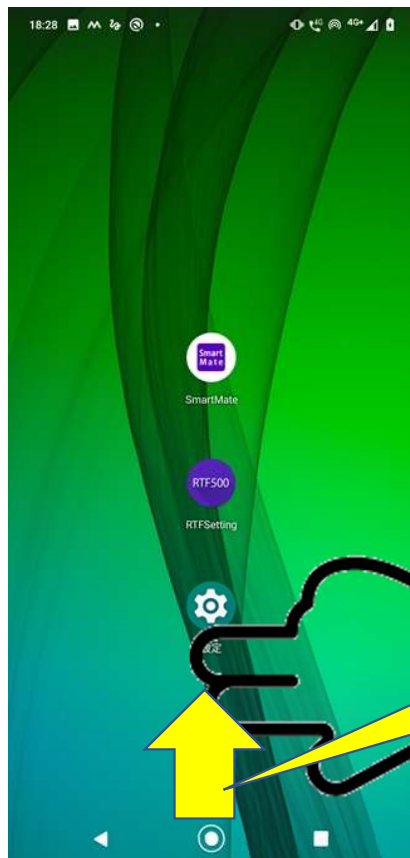

Install the latest version from



"Play Store".

e.g.) Motog7

\*The place of the "Play Store" on the screen may differ depending on the Android device.

e.g.) Motog7  
Swipe up with your finger  
on the bottom of the  
screen.



Tap "Play Store".

## 2-1. "RTFSetting" Installation

When installing "RTFSetting" for the first time or after uninstalling it

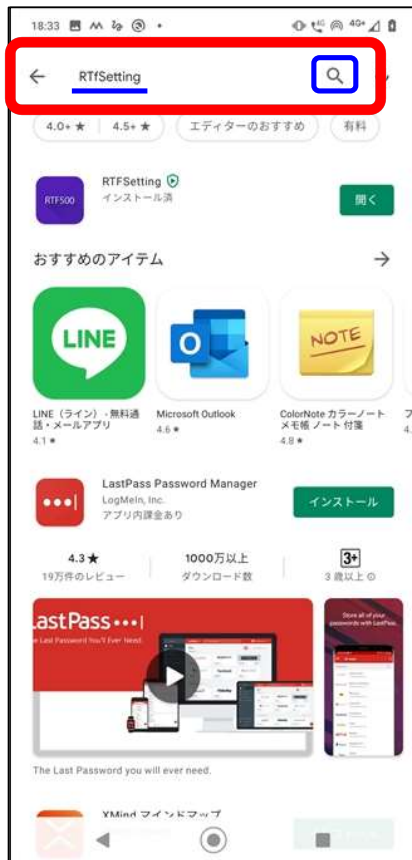

Enter "RTFSetting" in the search box and tap

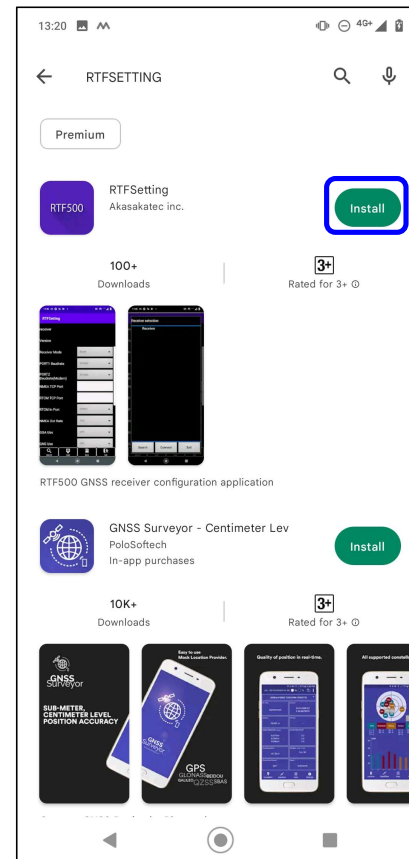

Tap "Install."

## 2-1. "RTFSetting" Installation

When installing "RTFSetting" for the first time or after uninstalling it



If you see a screen like the one on the left, select **"Download Now"** and tap **"OK"**.

**"RTFSetting"** is installed.

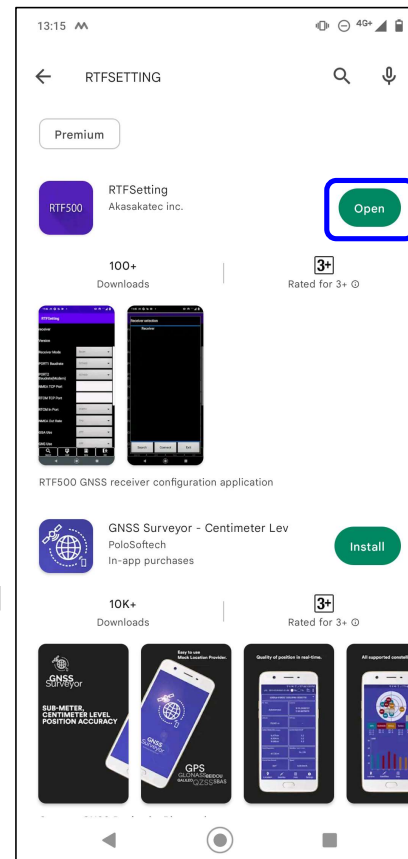

After installation, tap **"Open"**.

## 2-1. "RTFSetting" Installation

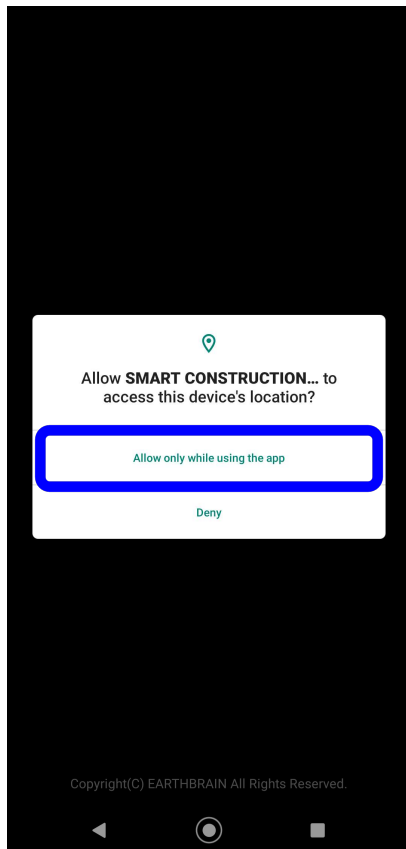

When the screen on the left appears, tap **"Allow only while using the app"**.

\*The message displayed and how to grant permission may differ depending on the OS version of the device.

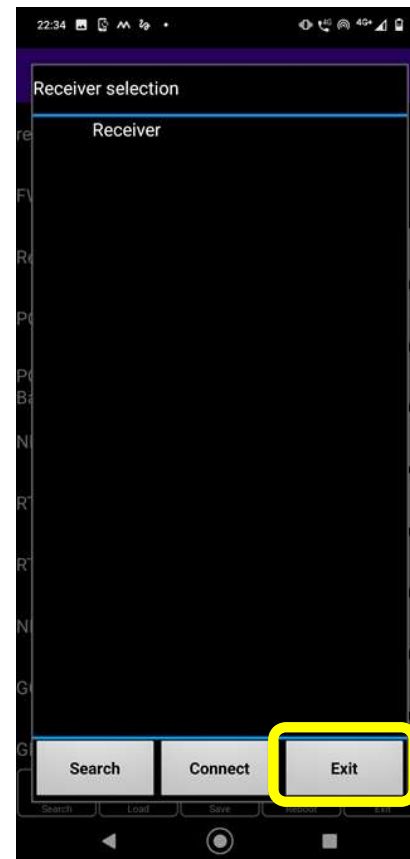

Tap **"Exit"**

## 2-1. "RTFSetting" Installation

When installing "RTFSetting" for the first time or after uninstalling it

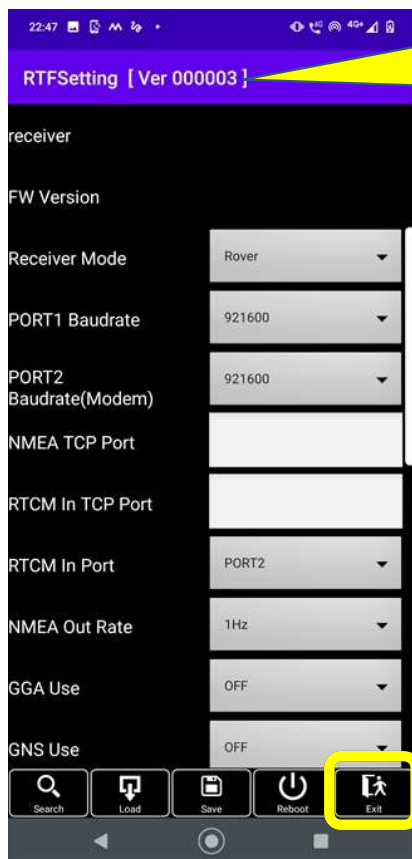

The version of "RTFSetting" installed.

Tap "Exit" to close the application.

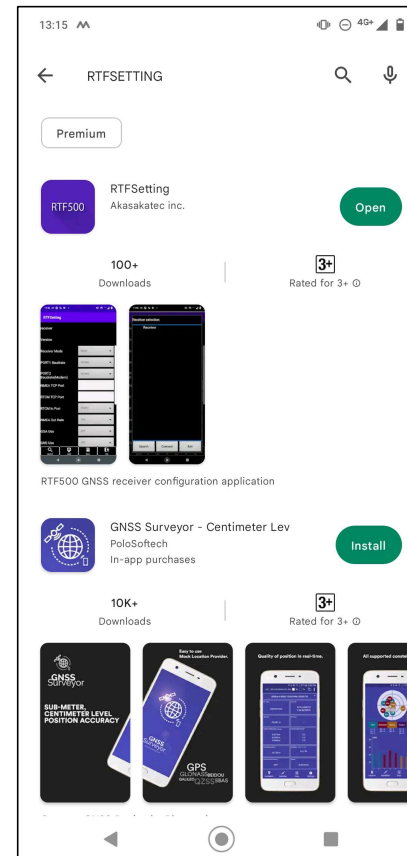

The installation of "RTFSetting" is complete.

# Chapter 3

## RTFSetting Version Up

## 3-1. RTFSetting Version Up

Check the current version.

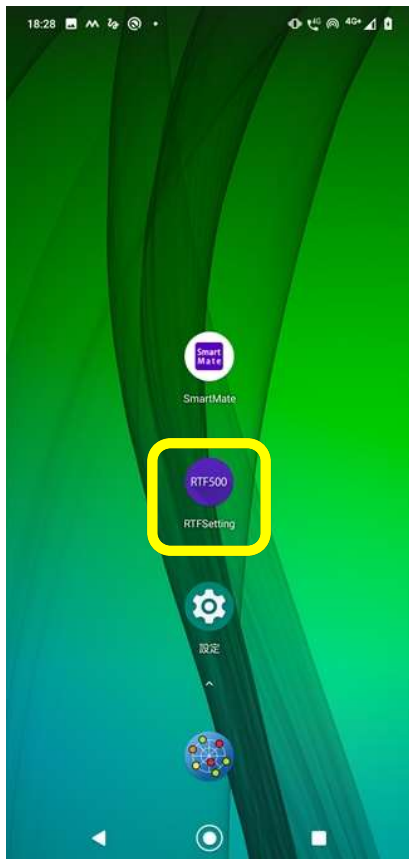

Tap "RTFSetting".

\*The place of the installed "RTFSetting" icon may differ on each device.

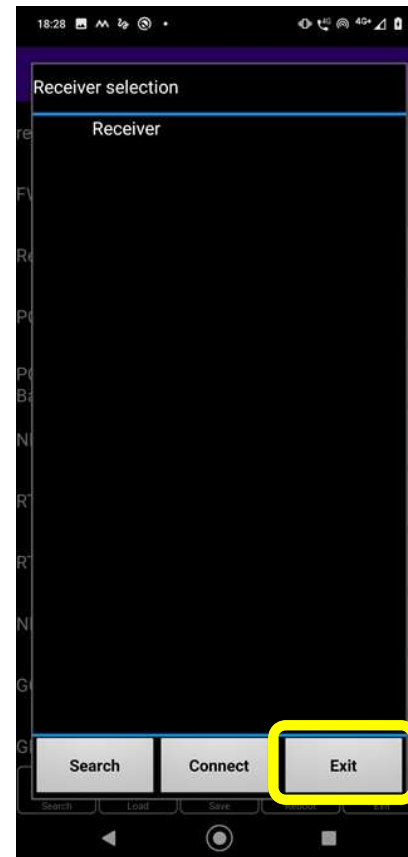

Tap "Exit"

# 3-1. RTFSetting Version Up

Check the current version.

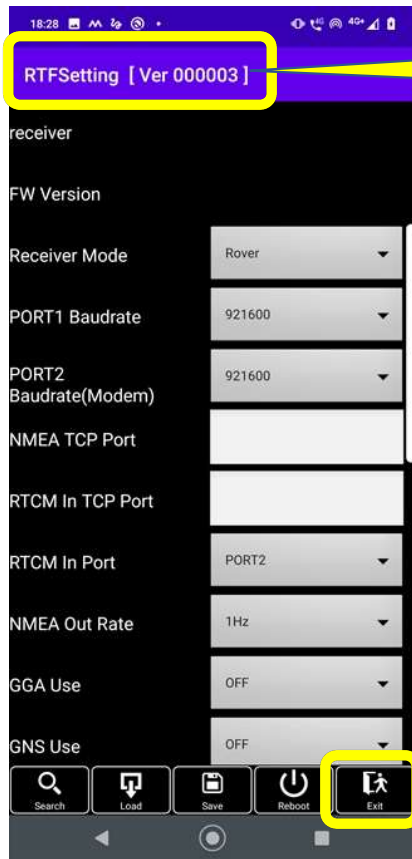

**Current Version**

The currently installed version is displayed.

Confirm the version, and then tap "Exit" to close the app.

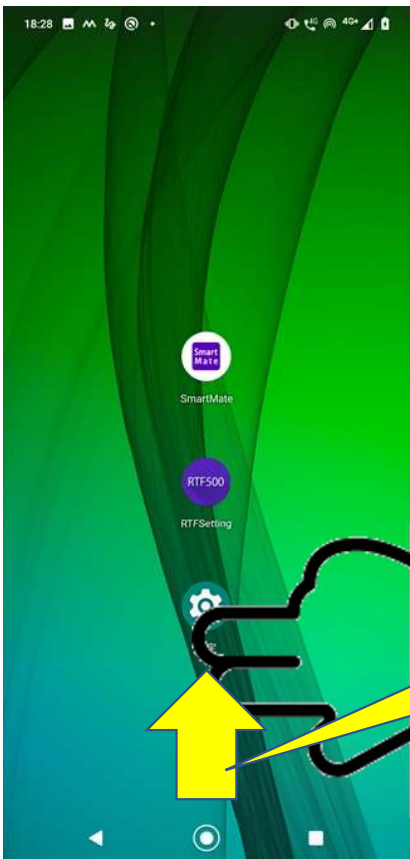

e.g.) Motog7

Install the latest version from



**"Play Store".**

\*The place of the "Play Store" on the screen may differ depending on the Android device.

**e.g.) Motog7**  
Swipe up with your finger on the bottom of the screen.



# 3-1. RTFSetting Version Up

Check the latest version.



e.g. : Motog7



Tap "Play Store"



Enter "RTFSetting" in the search box and tap



# 3-1. RTFSetting Version Up

Check the latest version.



Tap the "RTFSetting" icon.



If there is no updated version, "Open" will be displayed. please close the screen.

更新の内容  
最終更新: 2021/02/07  
beta 000003

Check "Update" for the latest version.

## 3-1. RTFSetting Version Up

### Install the latest version



If there is an updated version, **"Update"** will be displayed. Tap **"Update"** to install the latest version of "RTFSetting".

**Precautions**  
If the version of the Play Store is old, you may not be able to download the software.  
In that case, please upgrade the version of the Play Store.

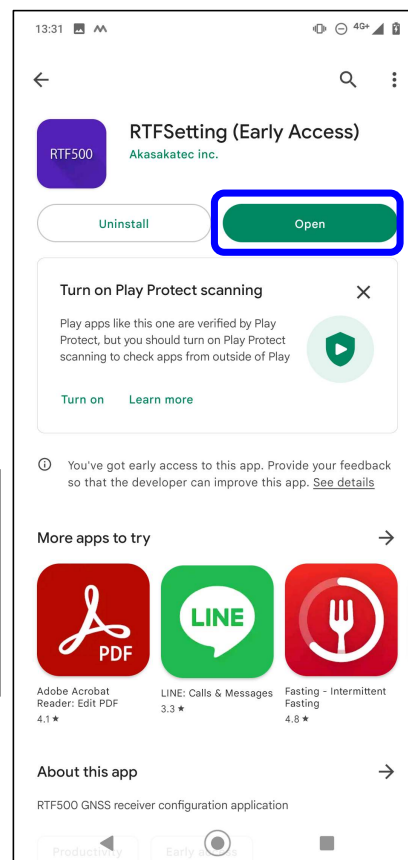

After the installation is complete, tap **"Open"**.

## 3-1. RTFSetting Version Up

### Install the latest version

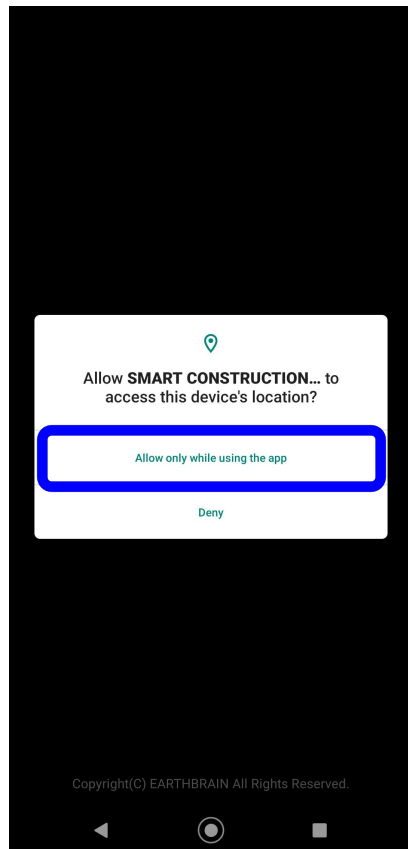

When the screen on the left appears, tap **"Allow only while using the app"**.

\*This screen will not appear if you have already installed the app and have "allowed" it before. If you have uninstalled and reinstalled the app, this will appear.

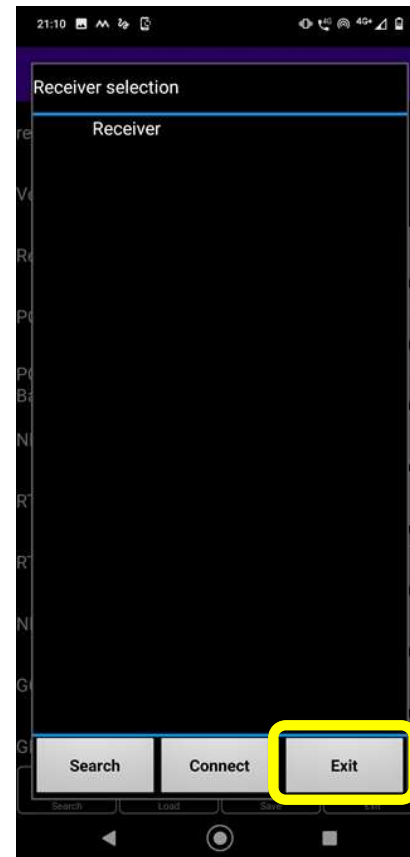

Tap **"Exit"**

# 3-1. RTFSetting Version Up

## Install the latest version

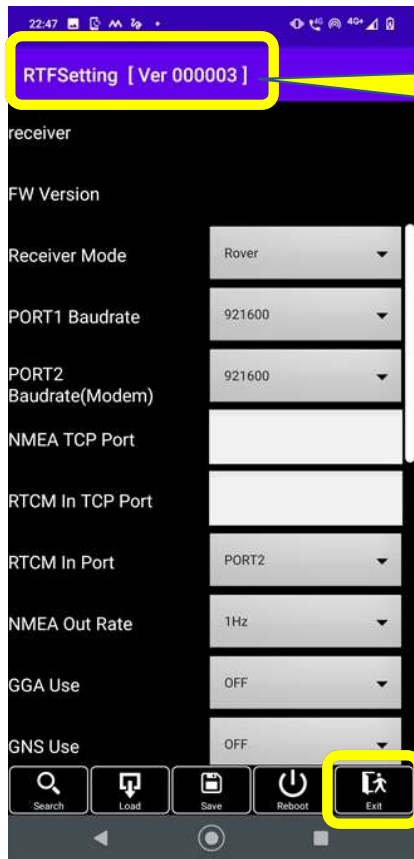

Check for updated version.

Tap "Exit" to close the app.

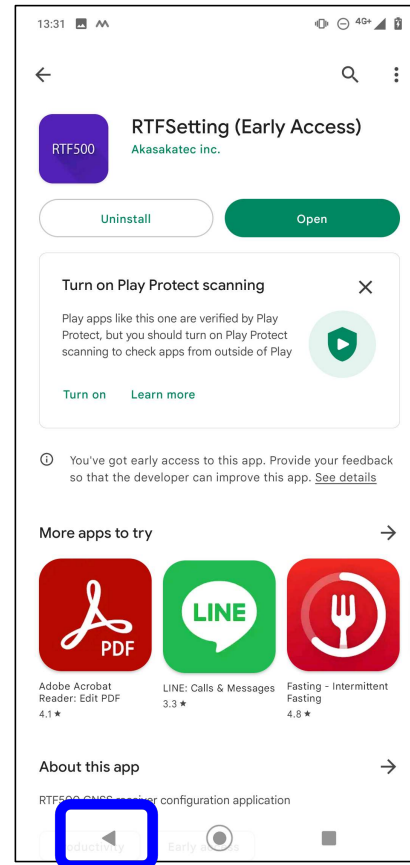

The update of RTFSetting is complete.

Close the screen.

# Chapter 4

## About the SC Rover

## 4-1. About the "SC Rover" Specification



2-frequency multi-GNSS receiver "SC Rover"

**Receive Channel:** 184 Channel.

**Received signal:** GPS L1C/A, L2C  
GLOANSS L10F, L20F  
GALILEO E1-B/C, E5b  
BeiDou B1I, B2I  
QZSS L1C/A, L2C

※QZSS is not used for RTK analysis.

**Accuracy (RTK):** Horizontal 0.01m+1ppm (× Baseline Distance) C.E.P  
Vertical 0.01m+1ppm (× baseline distance) C.E.P

※ Depends on the environment. We do not guarantee accuracy.

**Dust and Water Resistant:** IP65 (when the connector is covered with a special cap)

※ Please note that the receiver is not installed outdoors as it is.

**Operating temperature range:** -20° C~60° C

※ When the temperature in the receiver exceeds the range due to direct sunlight or the like at the installation site.

It may stop working.

**External Power Supply Range:** DC9-36V

※ **Battery Life:** Operating for about 4 hours with × 4 AA batteries (for general nickel hydride batteries)

**It can be used in the RTK-GNSS base station and rover modes.**

※ We do not guarantee compatibility with other manufacturers' GNSS receivers.



### Multi-GNSS antenna "AR270"

#### 4-FREQUENCY GNSS ANTENNA

L1, L2, L5, L6 Support

IP67: Can be installed outdoors at all times.

※ When installing outdoors at any time, protect the antenna cable connector with self-adhesive tape or the like.

## 4-2. "SC Rover" internal switch (back side of receiver: inside the battery case)

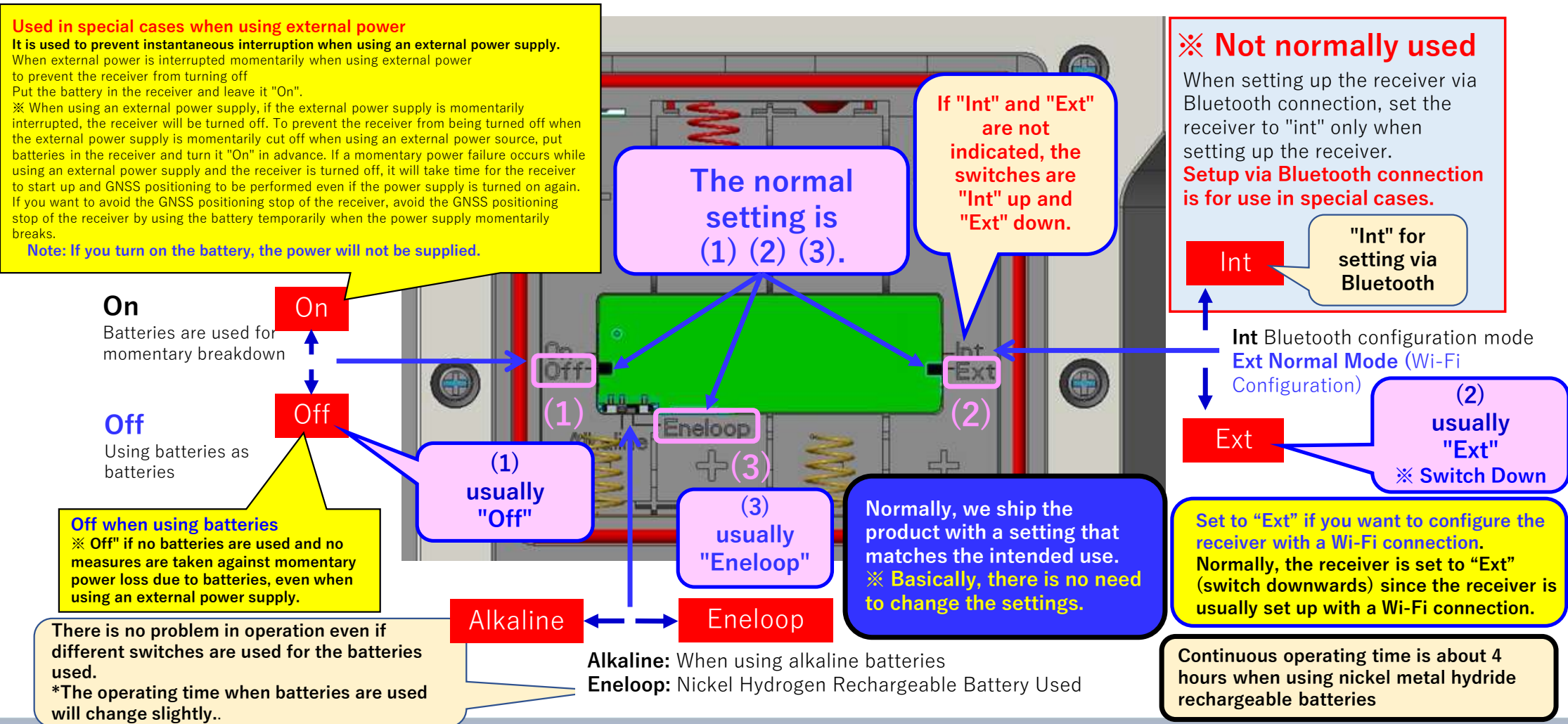



## 4-3. "SC Rover" Start and Stop

### Power Supply ON/OFF Button

※ Used for ON/OFF when using batteries.

Press for about two seconds.

When using external power, there is no need for button operation.

### When the battery is in use:

If the BATT light is "red", there is only a little battery left.

※ Please replace the batteries.

### ▶ Boot (Power ON)

#### ■ When using batteries

Press the "Power ON/OFF" button and the BATT LED will be "Green".

※ It will take a while (about 40 seconds) to start.

#### ■ With external power

When power is supplied externally, the BATT LED lights up "red" and the system starts automatically.

※ It will take a while (about 40 seconds) to start.

**After all LEDs (GNSS, WIFI, and BT) are turned on, the receiver starts.**

### When starting up in rover mode, GNSS lights up and WiFi/BT blinks.

This state is normal.

※ If GNSS is blinking, it does not capture the satellite.

### If you are using Komatsu Ntrip Caster in base station mode,

The WiFi lamp will light up when the server connection correction data is transmitted normally.

### ▶ Power Off Stop

#### ■ When using batteries

When the BATT LED "Green" lights up, press the "Power ON/OFF" button to stop.

※ It will take a while to stop.

#### ■ With external power

Turn off the external power supply when the BATT LED "Red" is turned on, then it stops.

There is no button press.

※ It will take a while to stop.

If all LEDs are turned off, the startup will be stopped.

### About GNSS Receiver Reset

There is no reset operation of the GNSS receiver.

※ Resetting on startup (read final settings after reset)

### About Firmware Updates (Automatic Updates)

Power "ON" and all LEDs (GNSS, WiFi, BT) remain lit (Usually about 1 minute) When power is automatically "OFF"

**The firmware for "SC Rover" may have been updated automatically.**

• Please press the power button again to turn it on when using a battery.

• When using an external power supply, it will be automatically restarted and the power will be "ON".

※ See Chapter 6

# Chapter 5

## Wi-Fi connection for “SC Rover” and “Android device”

When configuring the receiver with "RTFSetting", it is also necessary to configure the receiver with "SmartMate".

## 5-1. Wi-Fi connection for “SC Rover” and “Android device”

The "RTFSetting" setup application and "SmartMate" measurement application for the "SC Rover" will normally use a Wi-Fi connection for setup and measurement.

If the "SC Rover" and "Android device" are delivered separately, or if the "SC Rover" receiver itself to be used is changed, the access point settings for the "Android device" may have to be configured.

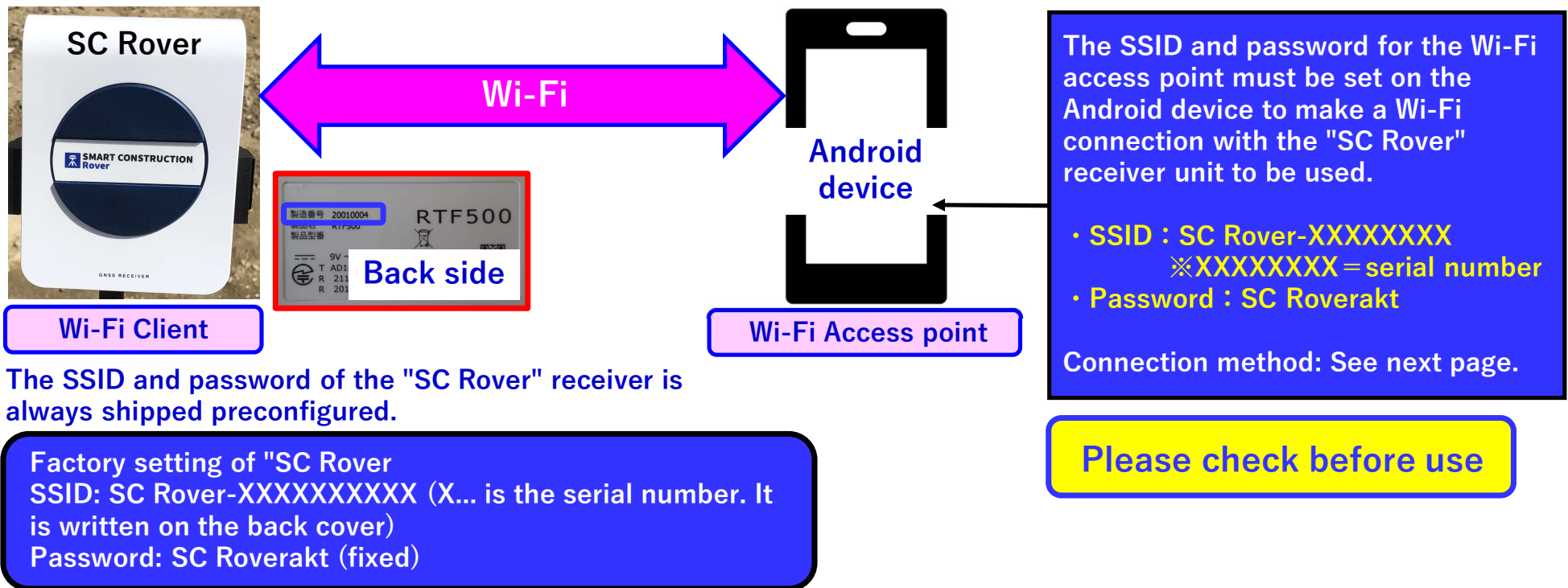

## 5-1. Wi-Fi connection for “SC Rover” and “Android device”

### Wi-Fi access point settings for Android devices

The setting screen may differ depending on your Android device or OS version.  
Please refer to the user's manual (web information) of the Android device you are using for the setting method.

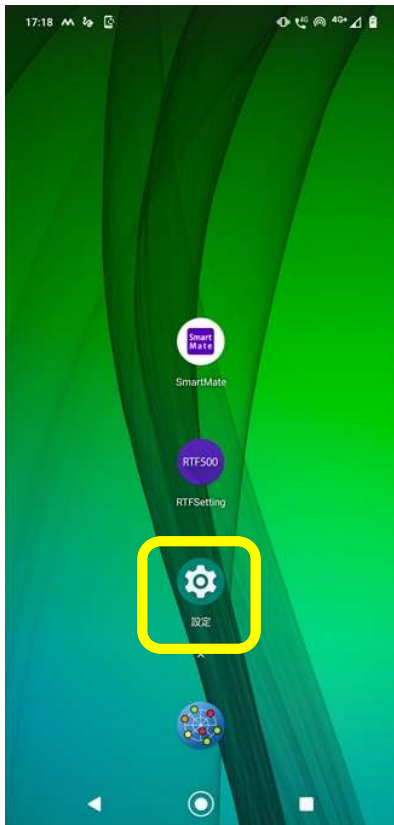

Example: Motog7

Tap "Settings".

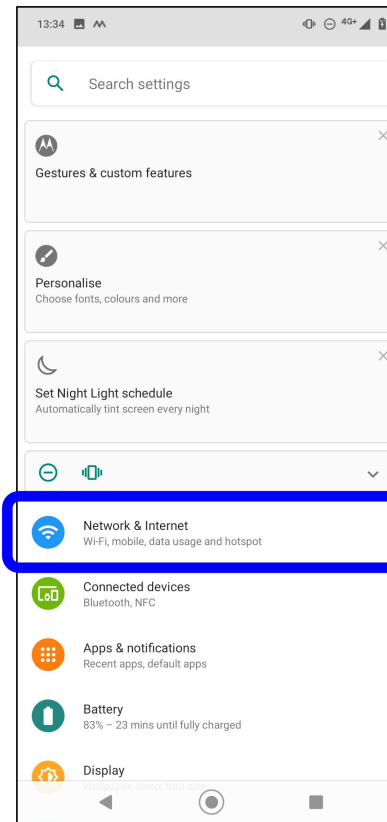

Tap "Network and Internet".

**\*The display location and name may differ depending on the device and OS version used.**

# 5-1. Wi-Fi connection for “SC Rover” and “Android device”

## Wi-Fi access point settings for Android devices

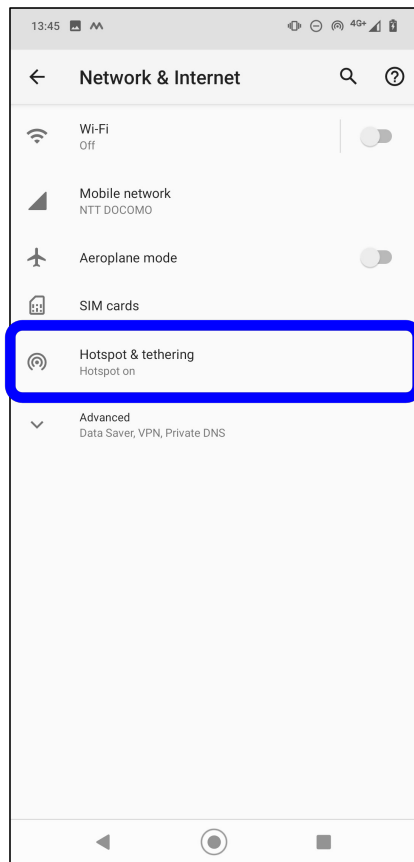

Tap “Hotspot & tethering”.

\* Depending on the device used, it may be "tethering".

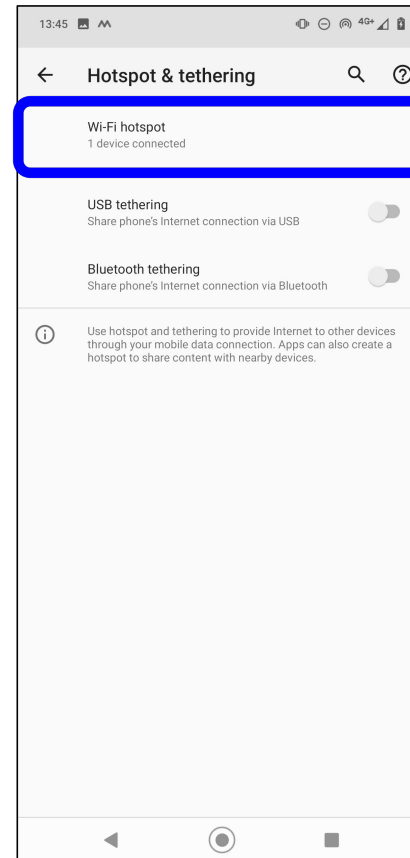

Tap "Wi-Fi hotspot".

\* Depending on the device used, it may be "tethering", "Wi-Fi tethering setting", etc.

## 5-1. Wi-Fi connection for “SC Rover” and “Android device”

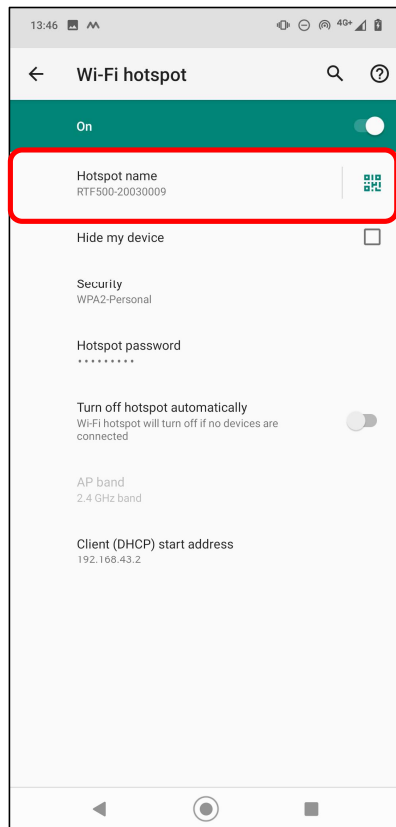

Tap “Hotspot name”.

\* The access point name (SSID) or network name (SSID) and password entry screen may differ depending on the device used.

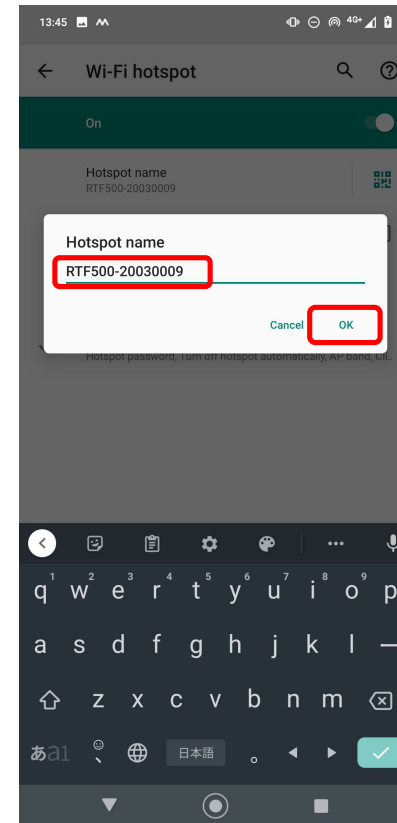

Don't forget the hyphen

Without fail enter RTF500-.

to hotspot name

**"RTF500-XXXXXXXX"**

→XXXXXXXX is the **SC Rover product number**

※Enter the number on the back cover of the SC Rover and tap "OK".

## 5-1. Wi-Fi connection for “SC Rover” and “Android device”

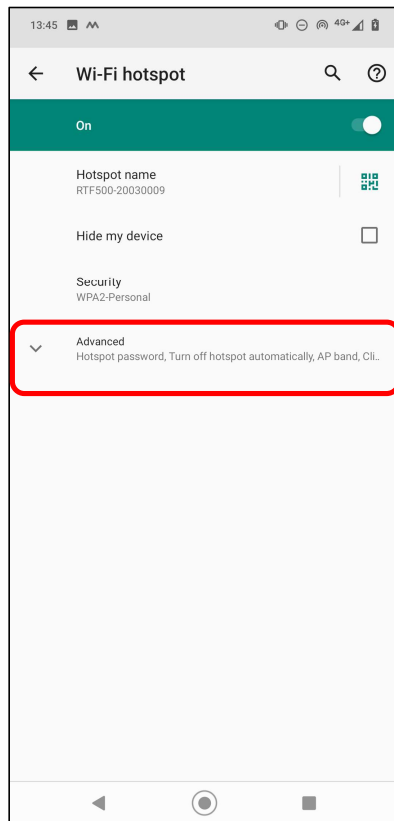

Tap "Advanced".

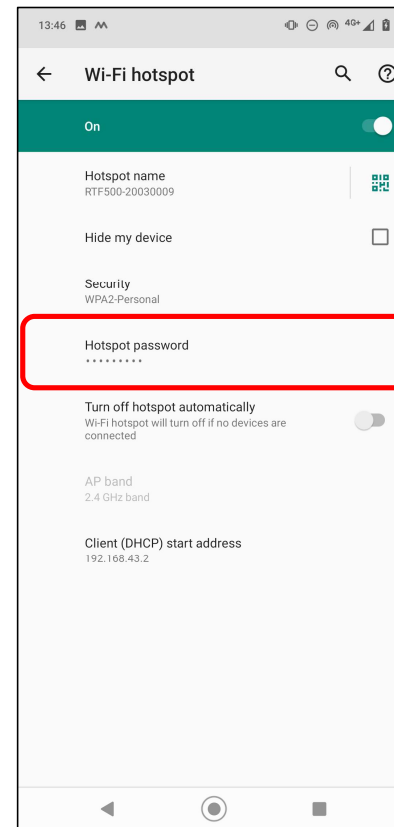

Tap "Hotspot password".

## 5-1. Wi-Fi connection for “SC Rover” and “Android device”

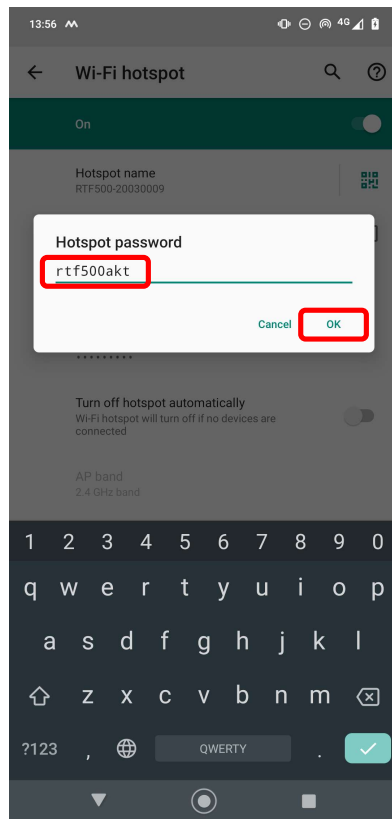

Enter the access point password  
"rtf500akt" and tap "OK"

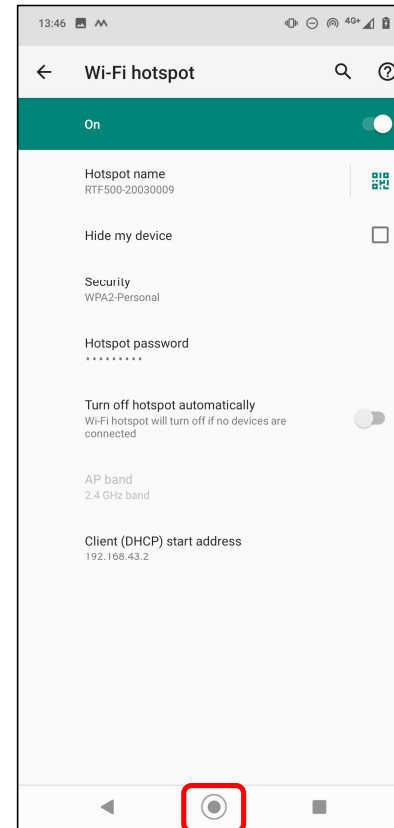

This completes the SSID and  
password settings.

Tap  and close the window



# Chapter 6

## "SC Rover" Firmware Update

## 6-1. "SC Rover" Firmware Update

### Automatic firmware update for "SC Rover"

When the latest firmware for "SC Rover" is released, it will be automatically updated when "SC Rover" is launched while the communication device paired with "SC Rover" is connected to the Internet.

If "SC Rover" and the "communication device" (usually an Android device) are set up for Wi-Fi (access point) connection and the "communication device" (usually an Android device) is connected to the Internet when "SC Rover" is started, the firmware will be automatically updated if there is updated firmware on the server.

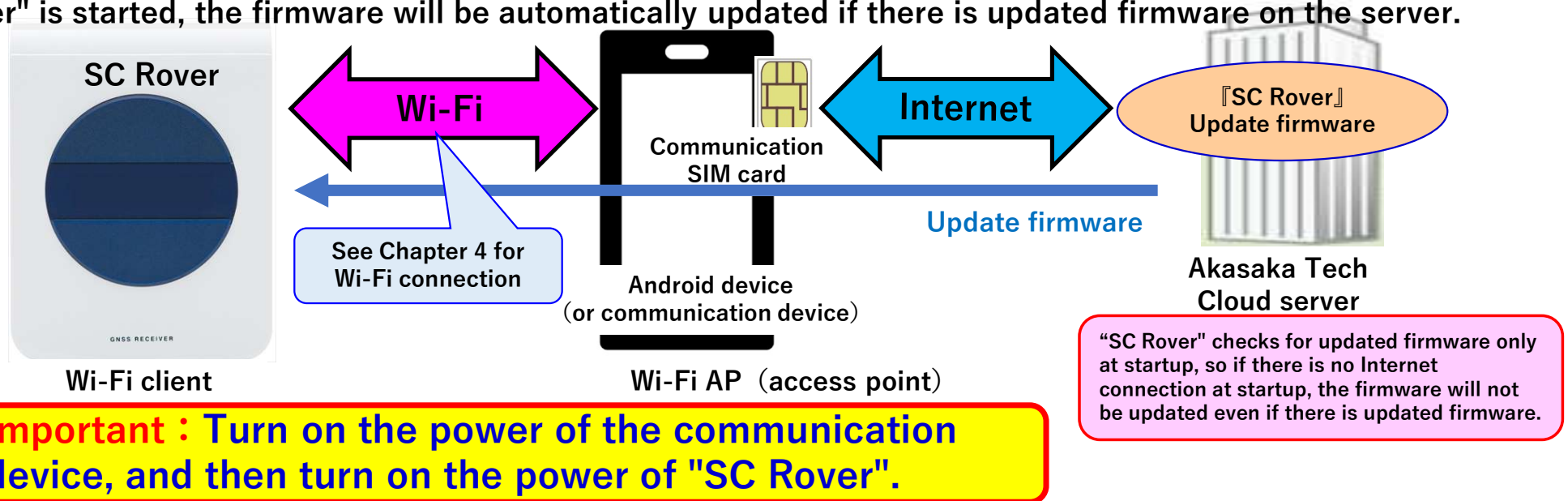

\*If the "SC Rover" is turned on first and the Android device or communication device is turned on later, it will not be updated automatically.

When the firmware update of "SC Rover" is performed, the power of "SC Rover" will be turned off after the update. (See next page)

## 6-1. "SC Rover" Firmware Update

### Automatic update of "SC Rover" firmware

If the latest firmware for SC Rover is released with a terminal paired with "SC Rover" connected to the Internet It will be automatically updated when you launch SC Rover.



#### ■ operation

BATT: Red on (external power)  
Green Light (Battery)

Used)

GNSS: On  
Wi-Fi: Blink  
BT:blinking  
→ Available.

Turn on the power supply and leave all LEDs (GNSS, WiFi, and BT) on.

After a few minutes (approximately 1 minute) the power supply automatically goes "OFF".

The firmware for "SC Rover" may have been updated automatically.

※ When using the battery, please turn the power back on after the power is automatically turned off.

When using an external power supply, it will automatically reboot and the power will be "ON".

The firmware update for "SC Rover"

Check if there is any update firmware on the server when "SC Rover" starts.

If the terminal is connected to the Internet at startup, it will be automatically updated; however, if the terminal is not connected to the Internet at startup, it will not be automatically updated.

※ The communication terminal configured to connect the "SC Rover" and the Wi-Fi access point

If you are connected to the Internet and you do not have to turn on the SC Rover "SC Rover" firmware will not be updated automatically.

**Important:** When using, please turn on the communication terminal, confirm the start, and turn on the "SC Rover".

# Chapter 7

## "SC Rover" Connection Specification

# 7-1. "SC Rover" Cable Specifications

About "SC Rover" connection cable "Port1" "Port2" cable.

**Port2 RS232C**

When using an external radio at a rover, an optional Port2 cable is required.

- Used to input correction data for external radios of Rover.

**Port1 RS232C, External power supply**

- Used to supply external power to the base station and rover
- Used to output correction data in the base station
- Used for NMEA data output in the rover

**Port2 cable**  
\*Option  
This is not a standard accessory and must be purchased separately.

**Port1 cable**  
\*Option  
SC Rover includes this as a standard attachment.

**DSUB9 female**

**Power supply wire (2-core)**  
Red: Voltage  
Black: Ground

## 7-2. The usual use of "SC Rover" and "SmartMate" (Ntrip) Using "SC Rover" as a rover with network RTK-GNSS (free choice of connection point)

Use "Rover", a measurement application, for measurement, localization, etc.

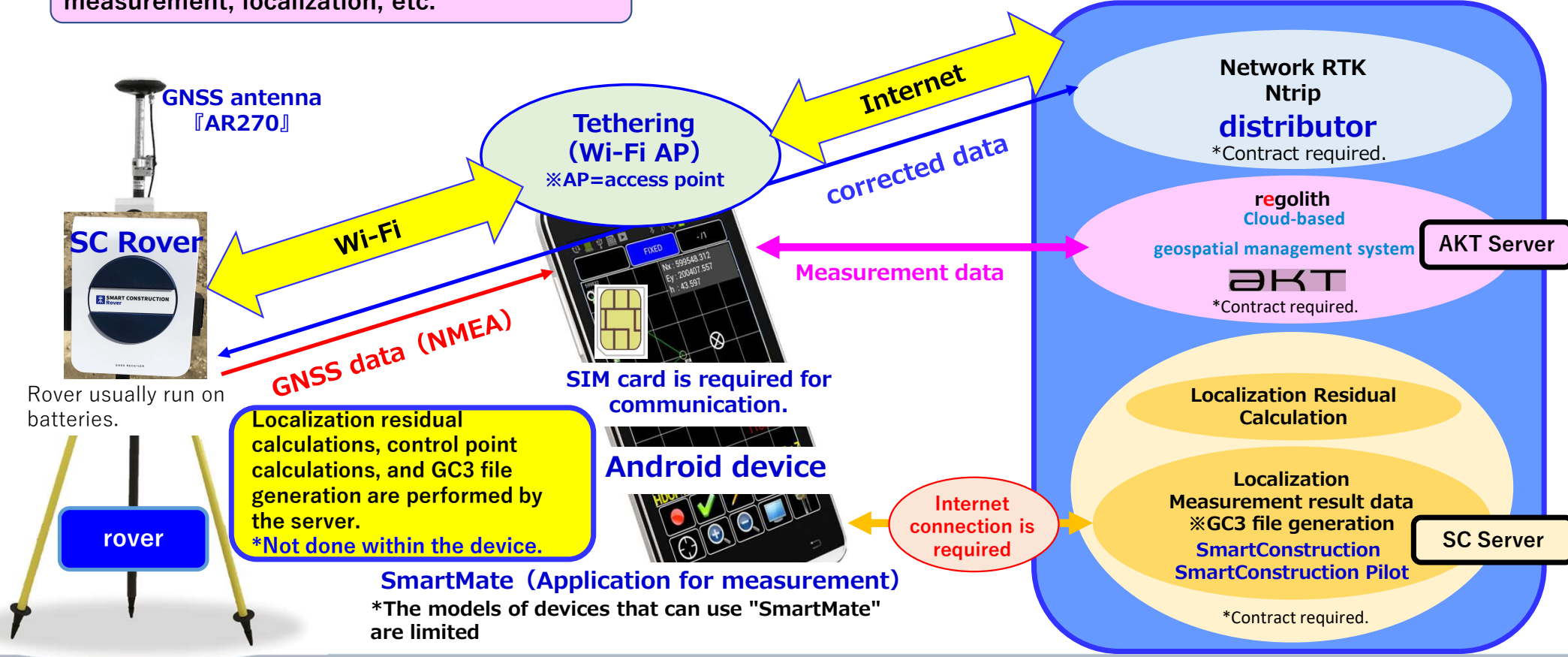

# 7-3.

## RTK-GNSS using "external radio" with base station "SC Rover" Using "SmartMate" with the rover "SC Rover"

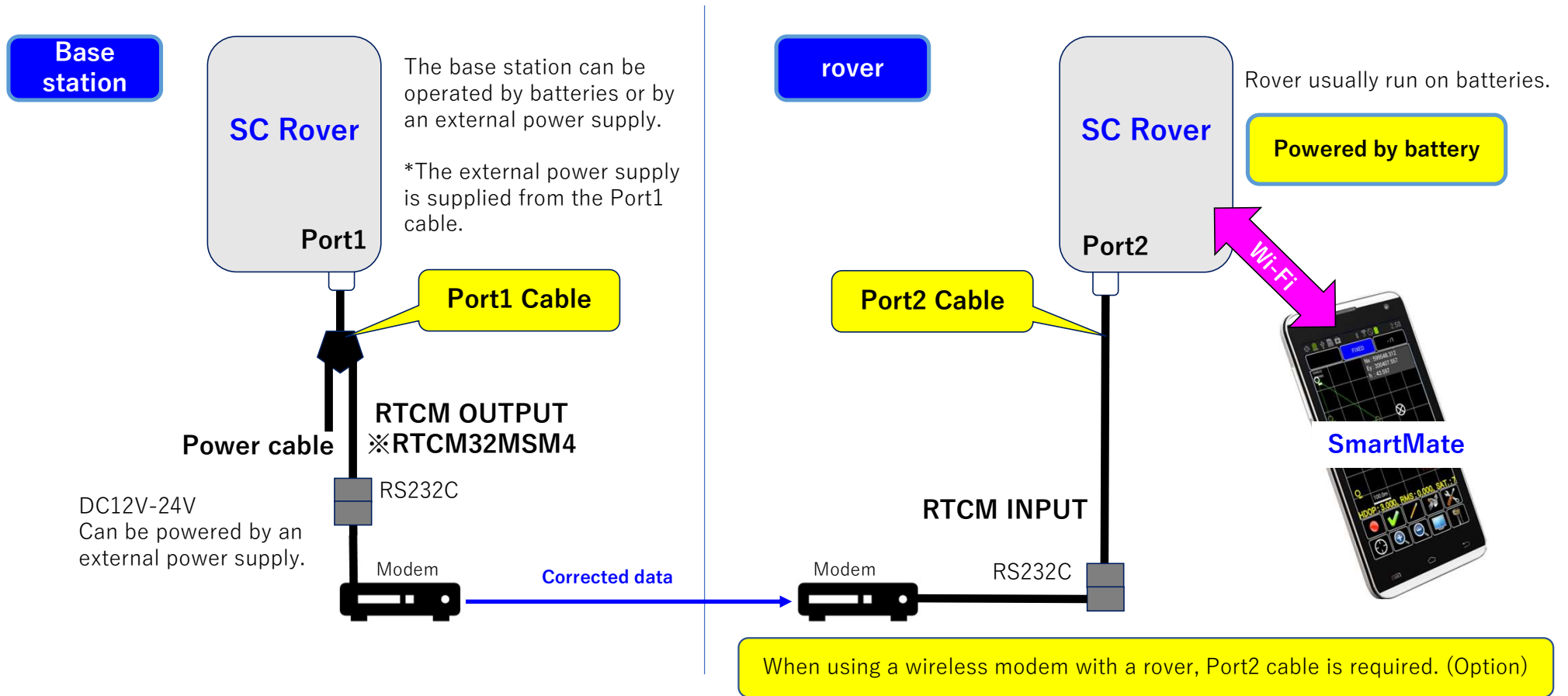

# 7-4.

## RTK-GNSS using "external radio" with base station "SC Rover" Using "retrofit kit, iMC Machine Type 11" as the rover

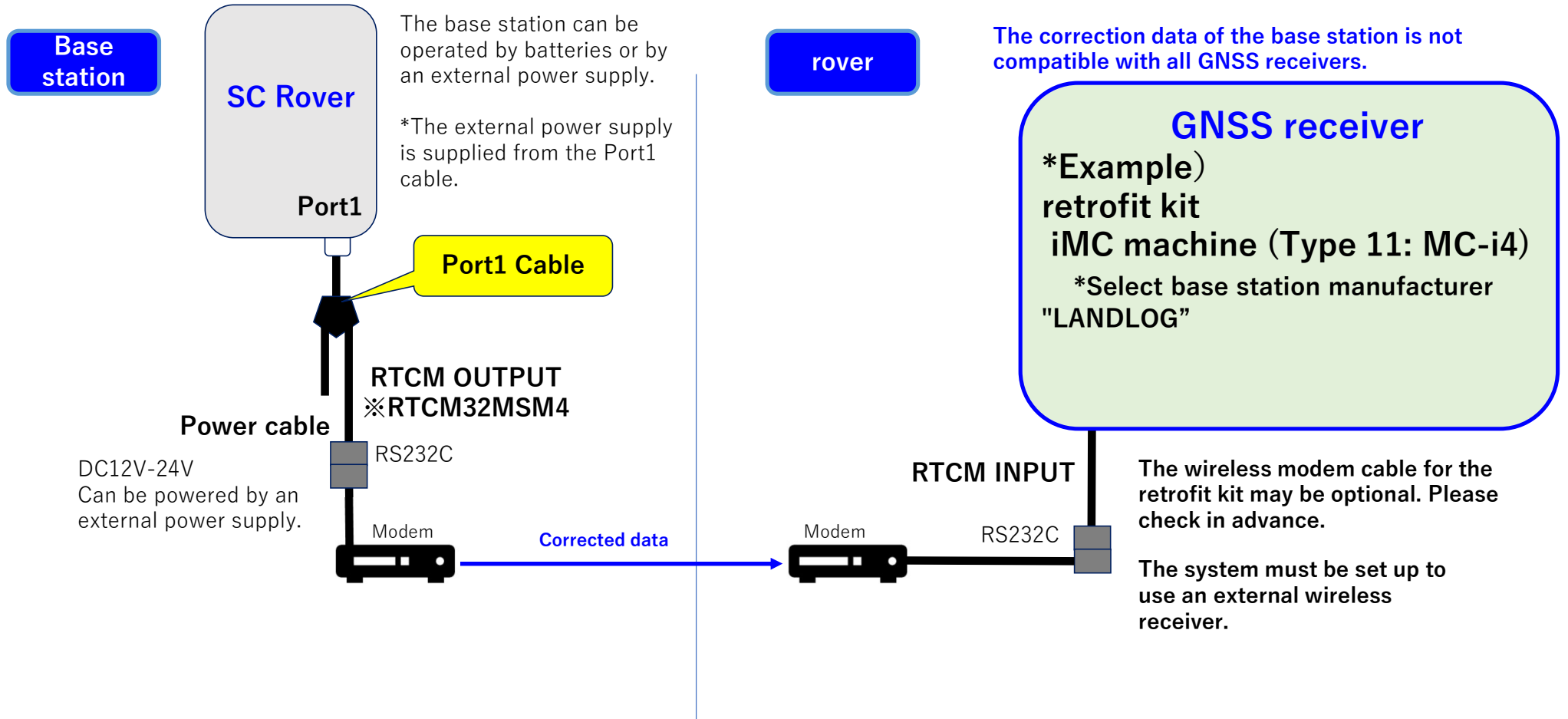



# 7-5.

## RTK-GNSS using "Komatsu Ntrip Caster" with base station "SC Rover" Using "SmartMate" with the rover "SC Rover"

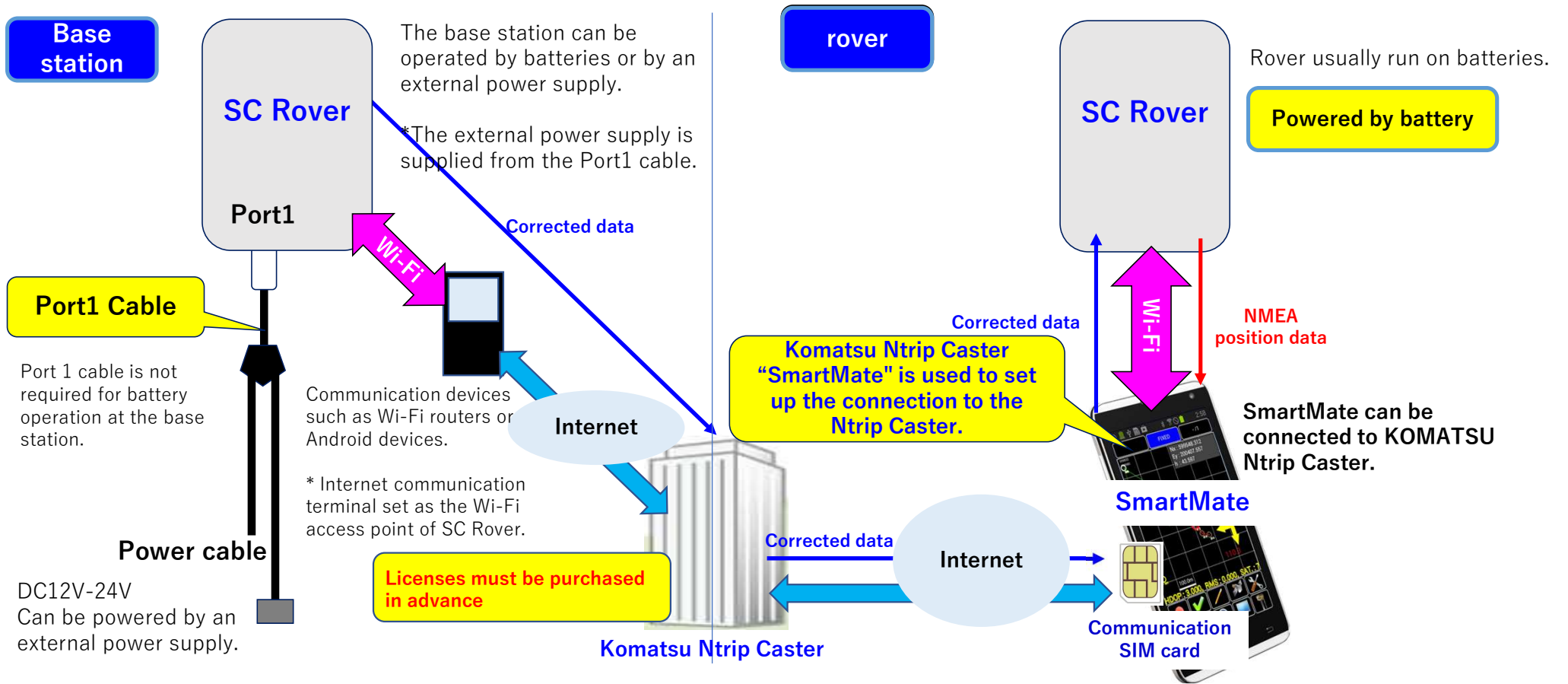

# 7-6.

## RTK-GNSS using "Komatsu Ntrip Caster" with base station "SC Rover" Using "retrofit kit, iMC Machine Type 11" as a rover

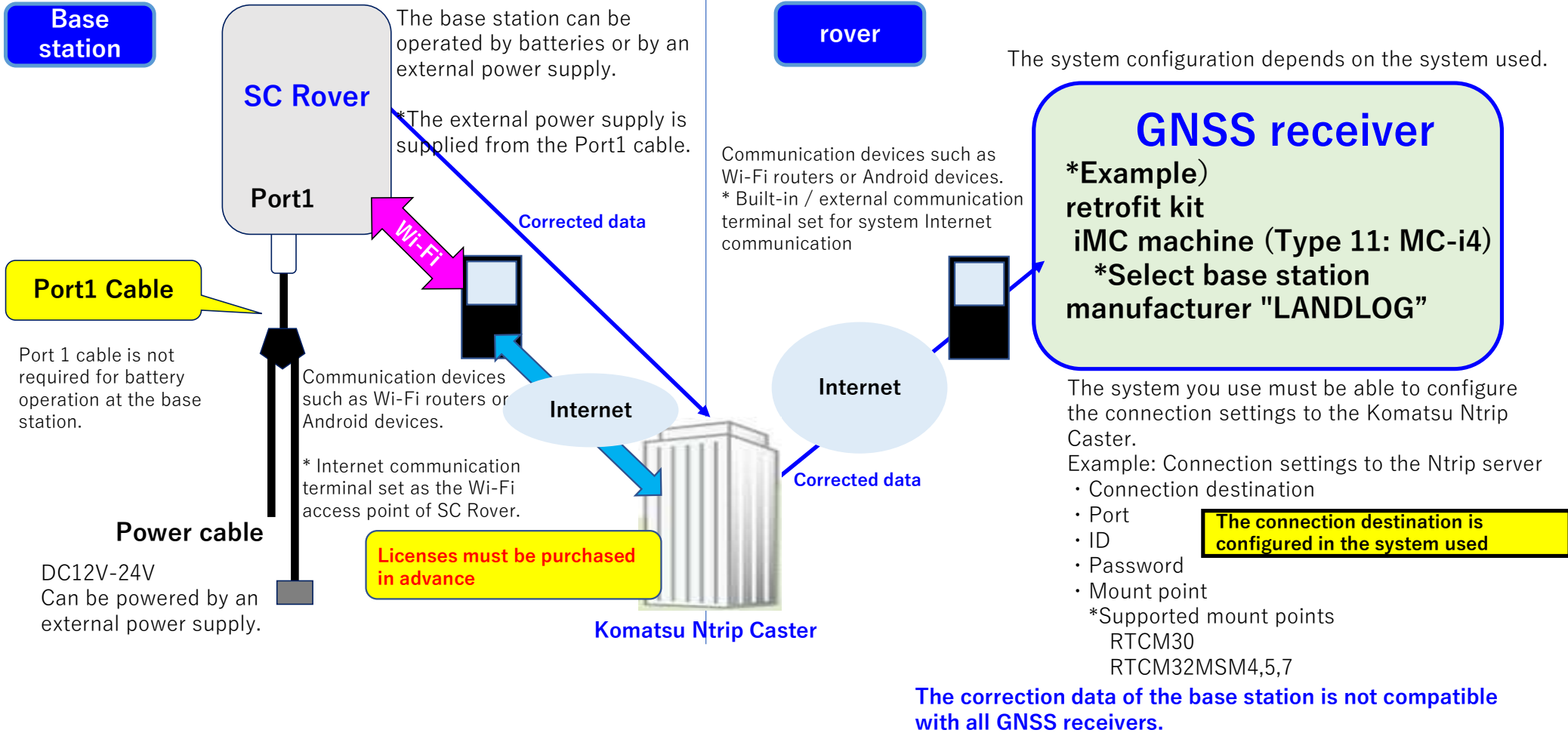

# Chapter 8

## “SC Rover” base station installation recommended specifications

## 8-1. “SC Rover” base station installation recommended specifications

### ★Speaking from experience

This is just our opinion as AKASAKATEC INC.

We sell and rent GNSS-based systems.

For construction sites where a radio modem must be used instead of a networked RTK-GNSS (Ntrip)

We intentionally use a separate GNSS receiver and GNSS antenna for base stations.

The receiver with integrated GNSS receiver, antenna, and radio transmitter is used by surveying companies for a day's surveying work, etc.

We do not think that the integrated type should be used in base stations at construction sites for long or medium term.

If the GNSS receiver and GNSS antenna are separated, they can be installed in the field house or guard box, and the GNSS antenna and radio transmitter antenna can be connected to a single pipe or other equipment.

GNSS antenna and radio transmission antenna will be installed.

In addition, an AC100V power supply is secured at the location where the base station is installed, and the base station is permanently installed from the start of the site to the end of the site.

\*Because the GNSS receiver and GNSS antenna are separated, the antenna cable can be used to separate the receiver from the antenna installation site.

The antenna of the radio transmitter can also be separated from the installation site because of the cable connection.

### ★Disadvantages of using a GNSS receiver with integrated GNSS receiver and radio transmitter at a base station

- ▣ Because the GNSS receiver, GNSS antenna, and radio transmitter are integrated, the installation location is fixed to a single location.
- ▣ If an AC power source is not available due to tripod installation at the base point, the GNSS receiver battery must be charged and replaced each time it is used.
- ▣ If the tripod is set up every morning, the receiver must be set up for each installation because the installation height changes.

# 8-1. "SC Rover" base station installation recommended specifications



GNSS antenna can be installed.

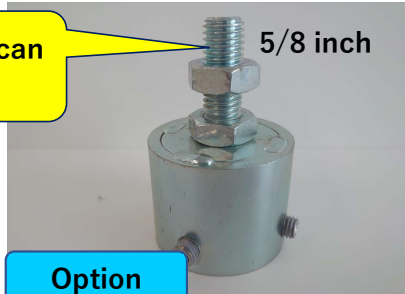

**Option**  
Single Tube Pipe Cap for GNSS Antenna Mounting

Installation can be done in the form of covering an ordinary single pipe.

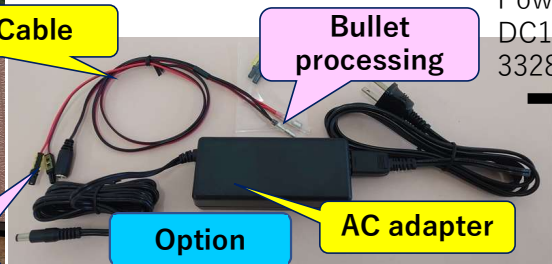

Relay Y Cable

Bullet processing

3328 connector

**Option** AC adapter (AC100V-240V → DC12V)

Power is supplied to the GNSS receiver and radio transmitter using an adapter from 100 VAC.  
\*The relay Y-type cable is bullet-processed for the power supply for the radio transmitter.  
Use 3328 connector for power connection for SC Rover.  
Attach the 3328 connector to the power line of the Port1 cable of the SC Rover.

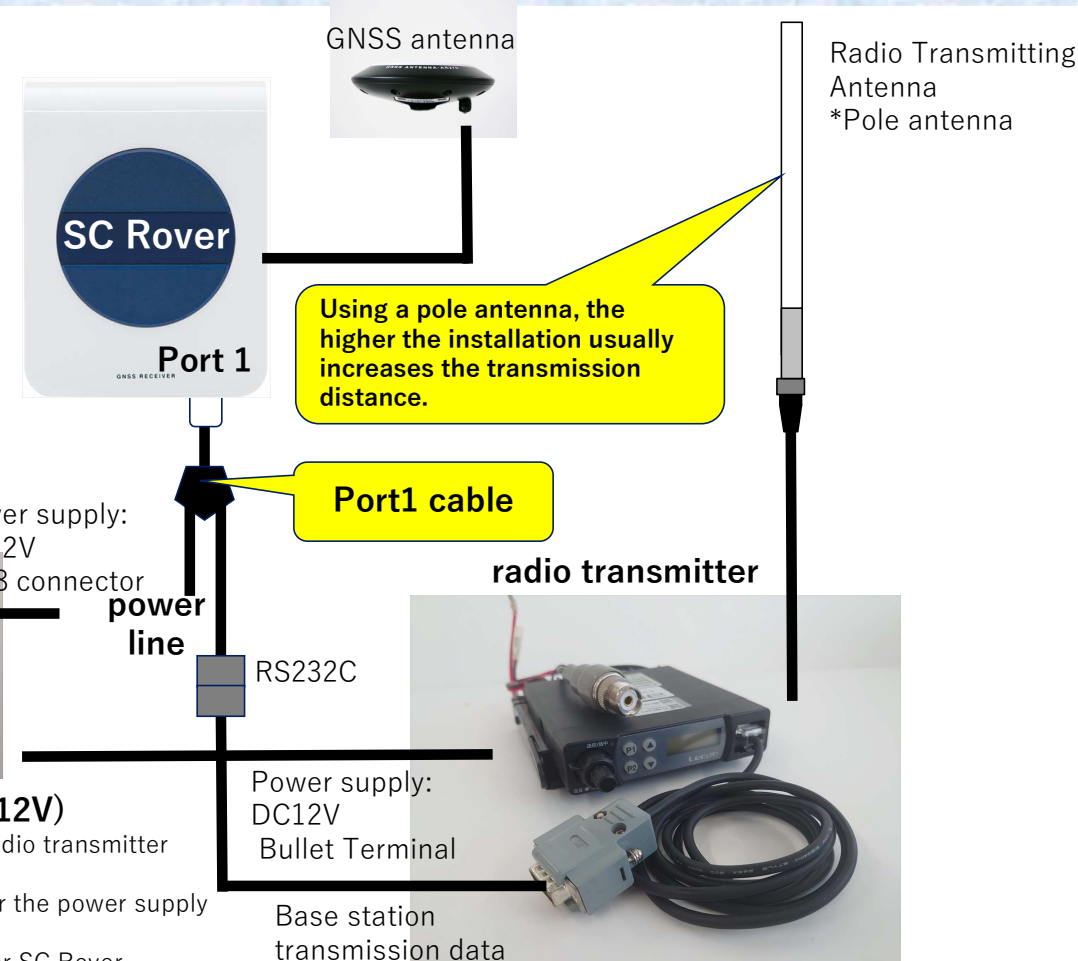

Using a pole antenna, the higher the installation usually increases the transmission distance.

Port1 cable

radio transmitter

Power supply: DC12V  
Bullet Terminal

Base station transmission data

# Chapter 9

## "SC Rover" Setup Preparation

## 9-1. "SC Rover" Setup Preparation

『The "SC Rover" receiver can be set via **Wi-Fi or Bluetooth** connection on an Android device with "RTFSetting" installed.

**Normally, "SC Rover" is configured with a Wi-Fi connection.**

※Setting up a Bluetooth connection is only used in special cases.

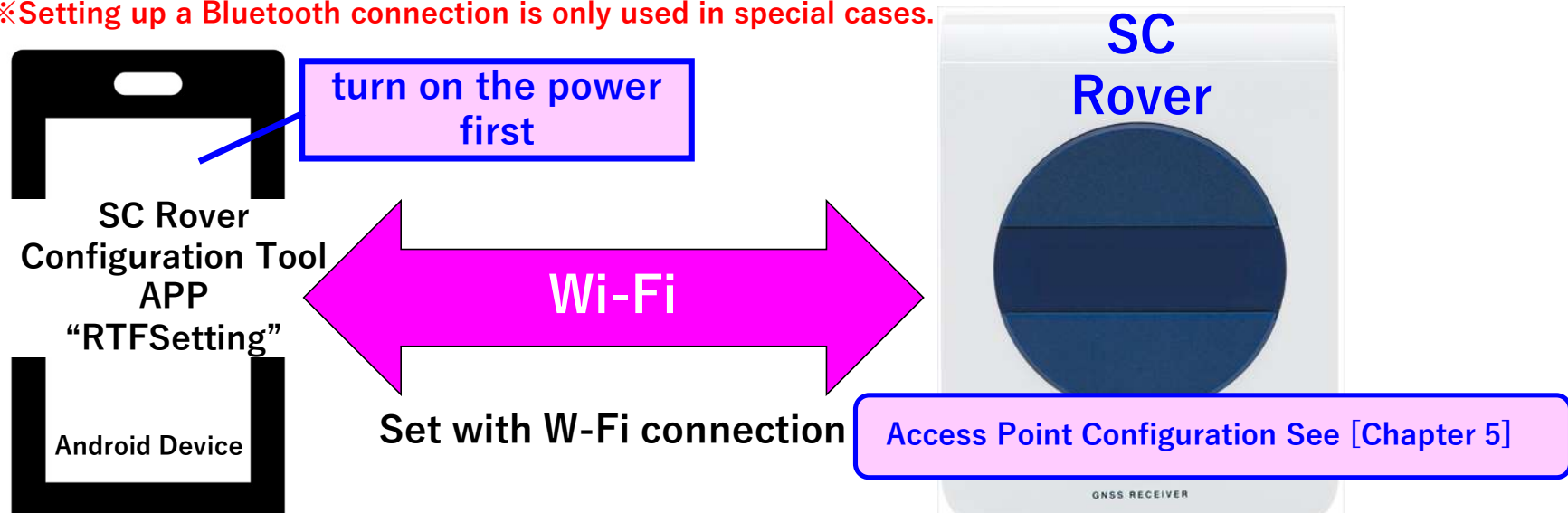

**Important: Turn on the communication terminal, confirm the start, then turn on the "SC Rover".**

You can configure with a W-Fi connection  
RTFSetting version 000003 or higher (as of April 2022:00008)  
SC Rover Firmware version 1.1.5 or higher (as of April 2022:1.2.)

# 9-1. "SC Rover" Setup Preparation

## "SC Rover" Setup Preparation

Verify that the access point is "ON" after the terminal is booted.



(e.g. Motog7)

**Motog7**  
with one's finger on the top  
of the screen  
slide down  
(swipe down)

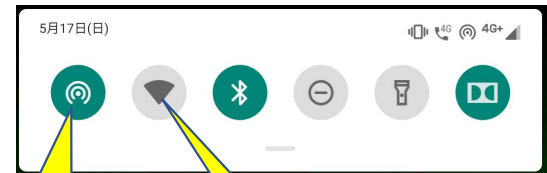

Make sure the access point is "ON".

Make sure the access point is "ON" and turn on the SC Rover



# 9-1. "SC Rover" Setup Preparation

## "SC Rover" Setup Preparation

If the WiFi on the terminal is "ON", it cannot be used by the access point.  
If Wi-Fi is "ON" then turn it "OFF" and turn the access point "ON".



If Wi-Fi is set to ON



Tap, and then



Turn it off.



Tap, and then



Turn on.

**Make sure the access point is "ON" and turn on the SC Rover**

# 9-1. "SC Rover" Setup Preparation

## "SC Rover" Setup Preparation

Once the SC Rover is up, make sure that the terminal and receiver are connected.



(e.g. Motog7)

**Motog7**  
with one's finger on the top  
of the screen  
slide down  
(swipe down)

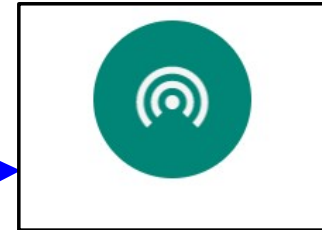
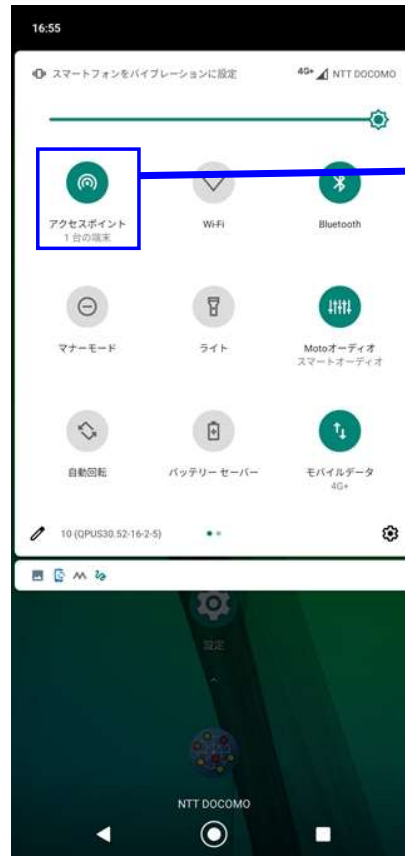

If the access point is displayed, the terminal and the receiver are connected, and you can configure the settings.

# 9-1. "SC Rover" Setup Preparation

## "SC Rover" Setup Preparation

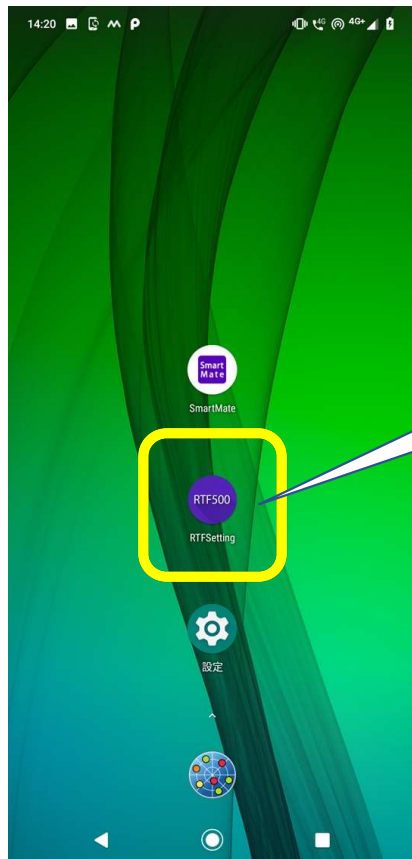

The "RTFSetting" can be downloaded from Google Play.  
\* Please check that it is the latest version.  
See Chapter 3

**RTFSetting.**  
Tap the icon.

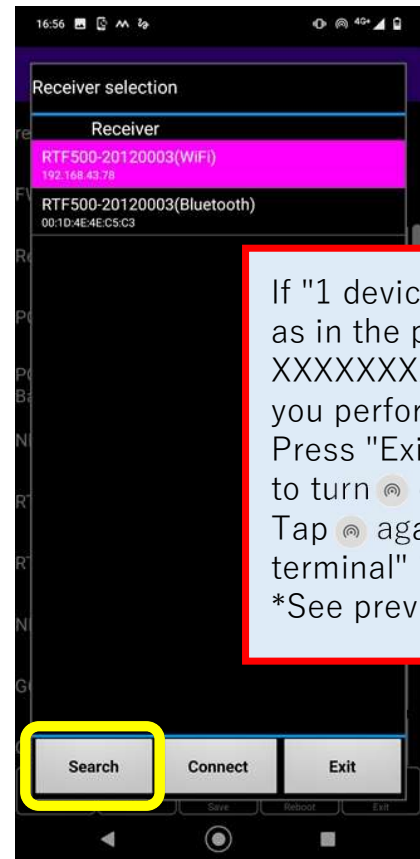

If "1 device" is displayed on the access point as in the previous page, but "RTF500-XXXXXXX (Wi-Fi)" is not displayed even if you perform "Search" in "RTFSetting", Press "Exit" once to exit the app, then tap to turn Wi-Fi off.  
Tap Wi-Fi again to make it ON, wait until "1 terminal" is displayed, and start "RTFSetting".  
\*See previous page.

Tap "Search".  
\* The information may be displayed without "Search".

# 9-1. "SC Rover" Setup Preparation

## "SC Rover" Setup Preparation

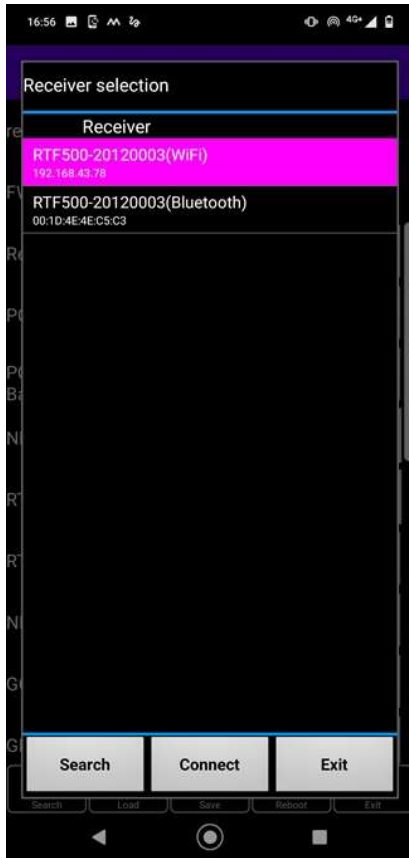

The serial number of the "SC Rover" Receiver found in "Search" is displayed.

The serial number of the SC Rover can be found on the back cover of the unit.

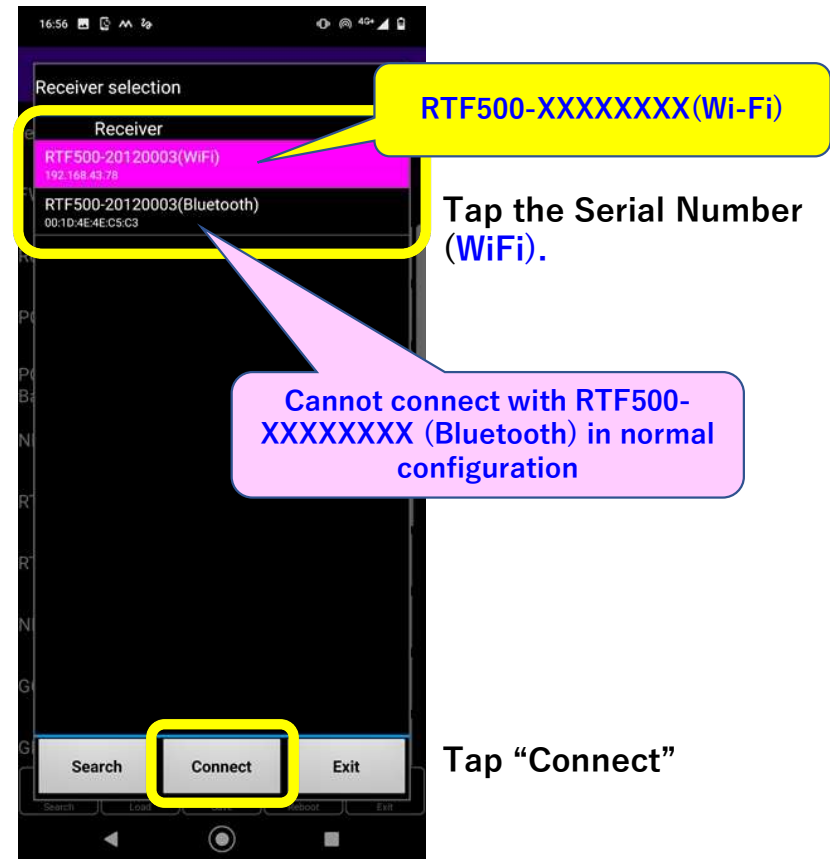

# 9-1. "SC Rover" Setup Preparation

## "SC Rover" Setup Preparation

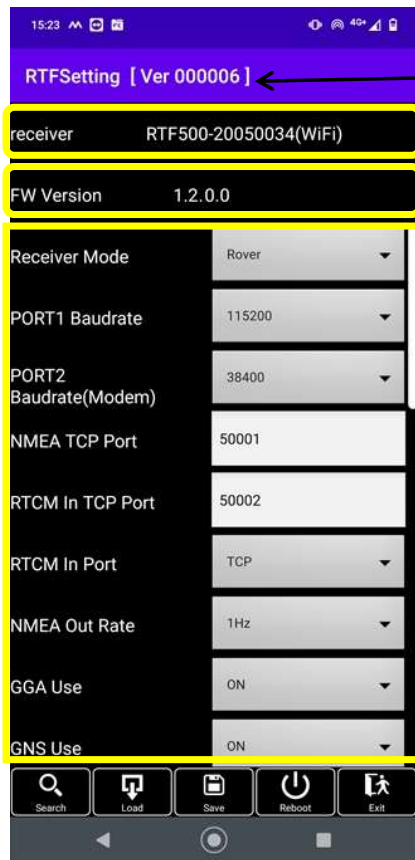

RTFSetting app version

When "SC Rover" and Android device are connected, the connected receiver's information will be displayed for the following items.

- receiver: **Serial Number (Manufacturing Number)**
- FW Version: **Receiver firmware version** is displayed.
- Current Receiver Configuration** is read and displayed.

\* Depending on the environment, you may not be able to connect once. In that case, please refer to the right.

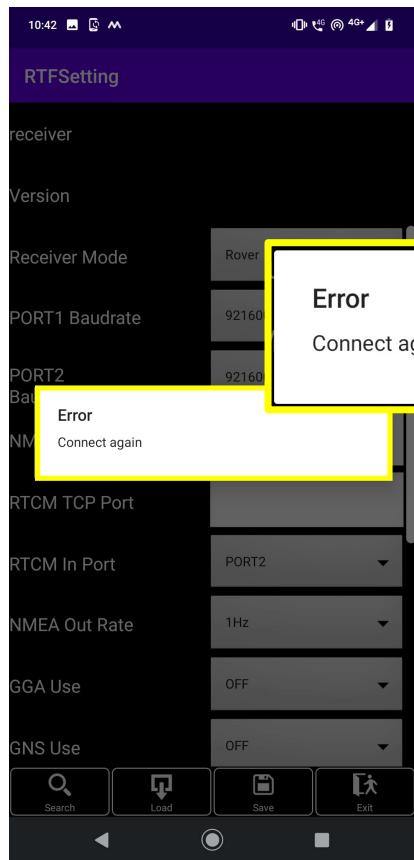

Error  
Connect again

When "Error" is displayed, tap "Search" and try "Connect" again.

If "Error" appears more than 3 times, restart the receiver by turning the power of the receiver off and on, and then execute again from "Search".

# Chapter 10

## "SC Rover" Setup

※ Setup of the base station and rover

# 10-1. Base station setup

## Base Station (Reference station)

## 10-1-1. “SC Rover” base station RTK Correction Data

■ When using an external radio with the “SC Rover” base station, the correction data to be transmitted outputs "RTCM32MSM4" from Port1 of the receiver.

\* You can also send with "RTCM32MSM7", but the amount of data will be about 1.7 times that of "RTCM32MSM4".

In order to reduce the amount of data to be transmitted, it is transmitted by "RTCM32MSM4".

\*When using Komatsu Ntrip, "RTCM32MSM7" is sent to the server.

■ Depending on the specifications of the external radio equipment used, it may not be possible to send all satellite information of the base station.

• In the case of ALINCO XETPD1, we have confirmed that it transmits without any problem in "1024 byte mode" when verified with multi-GNSS (GPS+GLONASS+BEIDOU+GALILEO), but if a problem occurs, please restrict transmission to a group of satellites.

If you have a problem, please transmit only "GPS+GLONASS" or "GPS+GALILEO" with the "512 byte mode" setting or with a radio transmitter that can only transmit in "512 byte mode".

• In case of Lecuo STANDARD U7000UJC181, multi GNSS (GPS+GLONASS+BEIDOU+GALILEO) can also be transmitted.

\*In case of transmitting multi-satellite, it is possible to transmit in normal mode, but the reception of mobile stations will be more stable and accurate if the setting is set to "Multi-compatible mode". (From the verification results).

→Multi-capable mode“ can be set with U7000UJC181 firmware version VER22 or later.

■ If the rover GNSS receiver does not support the correction data "RTCM3.2MSM4,5,7", it will not be RTK"FIX".

■ Even if the mobile station receiver supports the correction data "RTCM3.2MSM4,5,7", it may not be RTK "FIX" due to manufacturer specification compatibility.

※ Please check in advance.



## 10-1-2. "SC Rover" base station settings

Item	Setting Values and Descriptions
Receiver Mode	<b>Select</b> Base Station.
PORT1 Baudrate (Modem)	Sets the communication speed of PORT1 (RS232C). In base station mode, correction data is output from PORT1 when RTK is performed using a radio. Please match the communication speed set by the radio.
GPS	"ON" when using <b>satellites</b> , Select OFF <b>if</b> not used.
GLONASS	ditto
Beidou	ditto
Galileo	ditto
RTCM Interval(Sec)	1 is the default. ※ You cannot change this. (as of November, 2022)
Komatsu Ntrip Use	<b>When using Komatsu NtripCaster, set it to ON.</b> ※You need to purchase a license in advance to use it.
Komatsu Ntrip Host	Komatsu Ntrip Use"ON" will be displayed. Specifies the server to use. New Server=new server Old Server=old server Typically selected "New Server" after March 14, 2022.

Item	Setting Values and Descriptions
License status	Komatsu Ntrip Use"ON" will be displayed. When using Komatsu Ntrip Caster, you need to purchase a license and tap "Authentication" to log in during initial setup. If successfully authenticated, the "SC Company" and "SC User" are displayed, "OK" is displayed in "License status". * If "NG" is displayed, it is not authenticated. If you terminate your license or If you want to change it, use "Authentication clear" Tap.
Base Lat	Enter the latitude of the location where the base station GNSS antenna was installed. <b>deg(degrees).</b> <b>or enter in dms (in degrees and minutes)</b> [60 decimal system].
Base Lon	Enter the determine the longitude of the location where the base station GNSS antenna is installed <b>deg(degrees).</b> <b>or enter in dms (in degrees and minutes)</b> [60 decimal system].
Base Ellipse H	Enter the height ( <b>ellipsoid height</b> ) of the location where the base station GNSS antenna is installed.

## 10-1-2. "SC Rover" base station settings

Item	Setting Values and Descriptions
?	<p>Press the? button.</p> <ul style="list-style-type: none"> <li>• Base Ellipse H</li> <li>• Base Antenna H</li> <li>• Base Phase center H</li> </ul> <p>Displays how to enter height for.</p>
Select Base List	<p>You can file and select the base station coordinates (latitude, longitude, ellipsoid height).</p> <p><b>■ Cautions</b></p> <ul style="list-style-type: none"> <li>• The CSV file to register  <b>Under CSV UTF-8 (comma separated values) (*.csv):</b>                      It must be preserved.                      ※ For overseas correspondence</li> <li>• <b>Latitude and longitude are deg (degrees) [decimal]</b>                      It is input.</li> <li>• The CSV file to be loaded must be saved in the specified folder on the Android device.</li> </ul>
Base Antenna H	Enter the antenna height. (to bottom of antenna)
Base Phase center H	<p>Enter the antenna phase center height from the bottom of the antenna for the antenna being used.</p> <p><b>The AR270 antenna is "0.0386"m.</b></p>

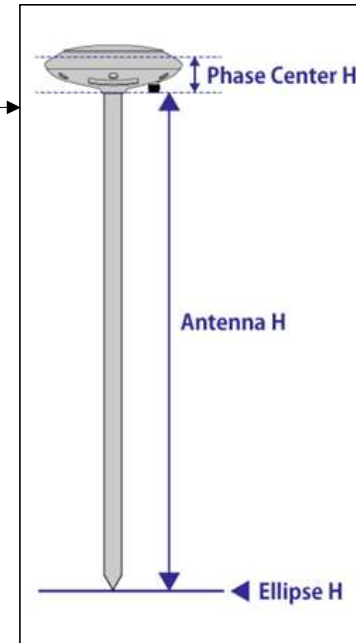

## 10-1-3. Pre-registration of base station coordinates

base station coordinates can be registered in advance, and setup can be performed by selecting the registered base station coordinates at the time of base station setup.

▣ No manual input of the reference coordinates is required during setup.

Even if you do not register, you can manually enter at the time of the base station setup.

This is useful when the installation of a base station is scheduled to be replaced at the site of use, or as a preventive measure against mistakes in the input of coordinate values at the site.

The base station coordinate registration is created in a CSV file format to be specified in advance and saved on the Android device to be used.

### ■ File conditions to register **Important**

- The CSV file to be registered must be saved in the **"CSV UTF-8 (comma delimited) (\*.csv)"** format in the specified file format.

※ For use overseas, it is **"CSV UTF-8 (comma separated value) (\*.csv)"**.

- **Latitude and longitude are input of deg(degrees) [decimal].**

- The CSV file that you are reading must **be saved in the folder specified** on the Android terminal.

※RTFSetting version 000006 or later

## 10-1-3. Pre-registration of base station coordinates

### About file formats

example) Microsoft Excel

	point designation	latitude	longitude	ellipsoidal height	
	A	B	C	D	E
1	P01	35.22481773	139.3841868	40.892	
2	P02	35.22569926	139.3836823	40.848	
3	P03	35.23033822	139.3835432	40.974	
4	P04	35.23094857	139.3838128	40.995	
5	P05	35.23136665	139.3844197	40.776	
6	P06	35.23153749	139.3855893	41.111	
7	P07	35.23137066	139.3903553	40.972	
8	P08	35.23095439	139.3909634	41.287	
9	P09	35.23001452	139.3912731	40.926	
10	P10	35.22538728	139.3910693	40.721	
11	P11	35.22476015	139.3901602	40.873	
12	P12	35.22450644	139.3850126	40.811	
13					
..					

No header, etc. is needed for line 1.

Column A: **Point Name**  
Column B: **Latitude** → deg (Degrees) [decimal] Input  
Column C: **Longitude** → deg (degrees) [decimal] Input  
Column D: **Ellipsoid Height**

## 10-1-3. Pre-registration of base station coordinates

### About file formats

example) Microsoft Excel

The screenshot shows the '名前を付けて保存' (Save As) dialog box in Microsoft Excel. The title bar indicates the file name '鳥浜護岸工事\_基準点.csv' and the status '保存しました' (Saved). The dialog is divided into several sections:

- Left Panel:** Contains navigation options like 'ホーム' (Home), '新規' (New), '開く' (Open), '情報' (Info), and '上書き保存' (Overwrite Save). The '名前を付けて保存' (Save As) option is highlighted with a red box and labeled (1).
- Right Panel:** Shows the save location 'この PC' (This PC) selected under 'その他の場所' (Other locations), highlighted with a red box and labeled (2).
- File Name Input:** The text '鳥浜護岸工事\_基準点' is entered in the input field, highlighted with a red box and labeled (3).
- File Type Selection:** The file type 'CSV UTF-8 (コンマ区切り) (\*.csv)' is selected in the dropdown menu, highlighted with a red box and labeled (4).
- Save Button:** The '保存' (Save) button is highlighted with a red box and labeled (5).

Additional annotations include a yellow box labeled 'Important' and a pink box labeled 'Save in CSV UTF-8 (\*.csv)' pointing to the selected file type.

- (1) File > Save As
- (2) Select Destination
- (3) File name input → **The file name is also valid in Japanese.**
- (4) **CSV UTF-8 (comma separated) (\*.csv)**
- (5) Save → The file is saved to the destination specified in (2).

## 10-1-3. Pre-registration of base station coordinates

**Migrate the created files to the Android device to be used.**

**Notes:**

In RTFSetting version 00006 and later, the folder in which files can be read is limited.

※ It is no longer possible to read from the "Download" folder of Android terminal.

The folders that RTFSetting can read files from

**Internal Shared Storage > Android > data > jp.akt.rtfsetting > files**  
**Limited.**

Migrate the files to internal shared storage > Android > data > jp.akt.rtfsetting> files.

## 10-1-3. Pre-registration of base station coordinates

Migrate the created files to the Android device to be used.

Example: Connecting PC to Motog 7

Connect your PC and Motog7 to a USB cable.

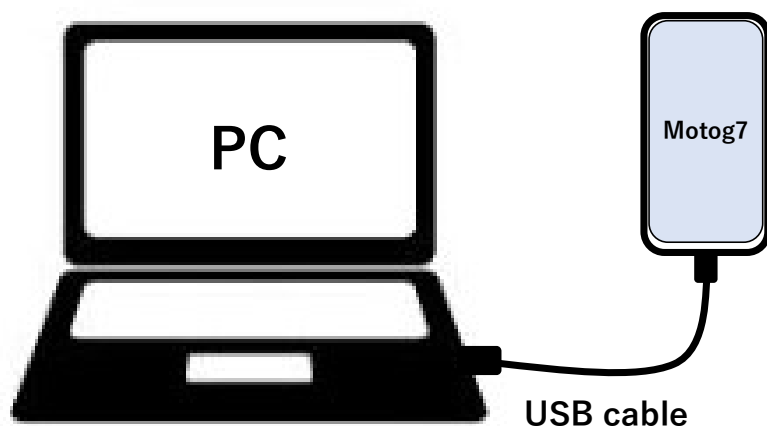

USB cable

※ USB cables have different connector types depending on the Android device model



Motog7

with one's finger on the top of the screen slide down (swipe down)

※ The operation of connecting to a computer varies depending on the Android device used.

## 10-1-3. Pre-registration of base station coordinates

Migrate the created files to the Android device to be used.

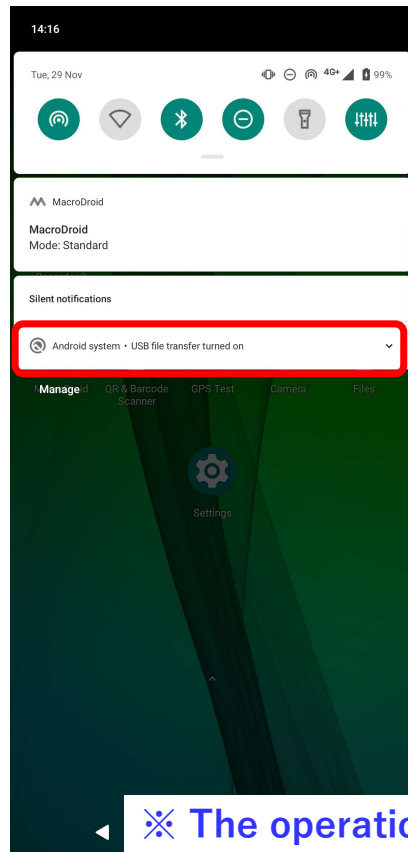

“Android System • USB file transfer turned on”  
Tap.

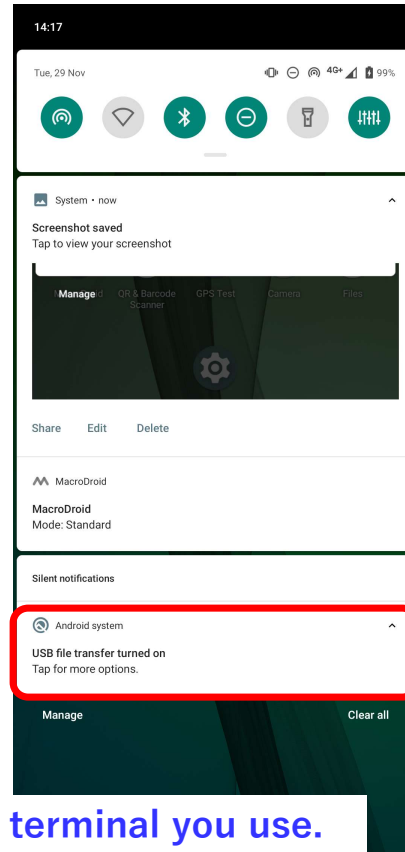

“USB file transfer turned on”  
Tap.

※ The operation depends on the Android terminal you use.



## 10-1-3. Pre-registration of base station coordinates

Migrate the created files to the Android device to be used.

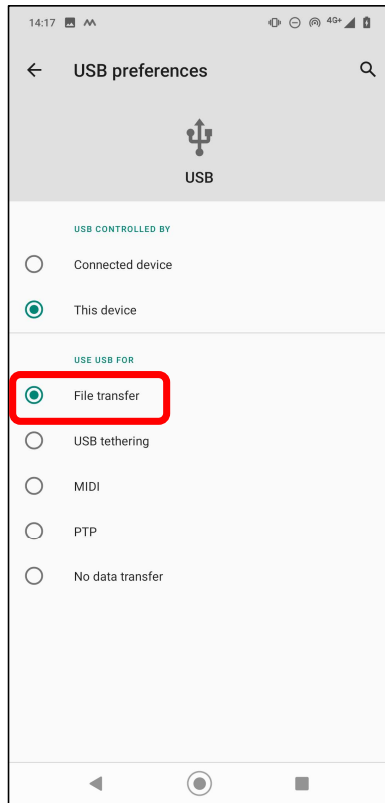

"File Transfer"  
Tap.

→ The terminal is recognized  
by the connected PC.

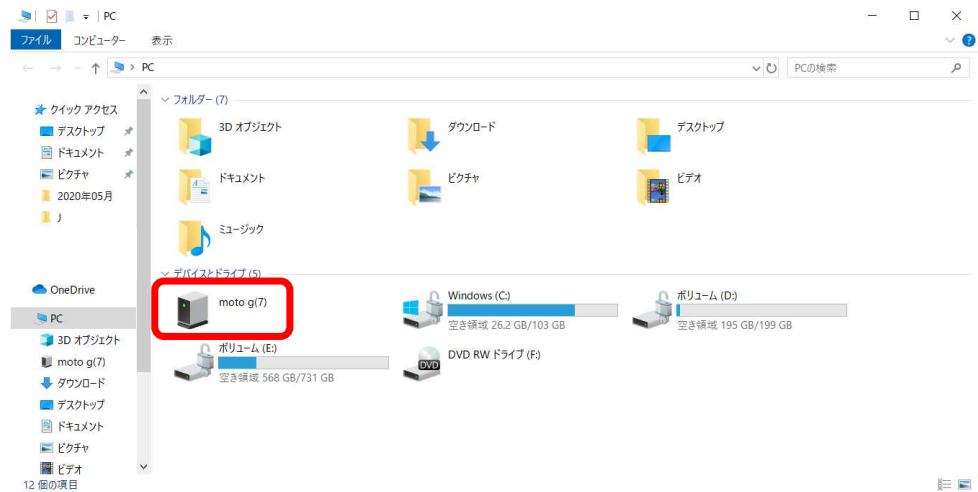

Open the "PC" on your computer.  
Double-click moto g(7).

## 10-1-3. Pre-registration of base station coordinates

### Migrate the created files to the Android device to be used.

Transfer (copy and paste) the file to the internal folder of the terminal (Motog7) that reads the reference point file.

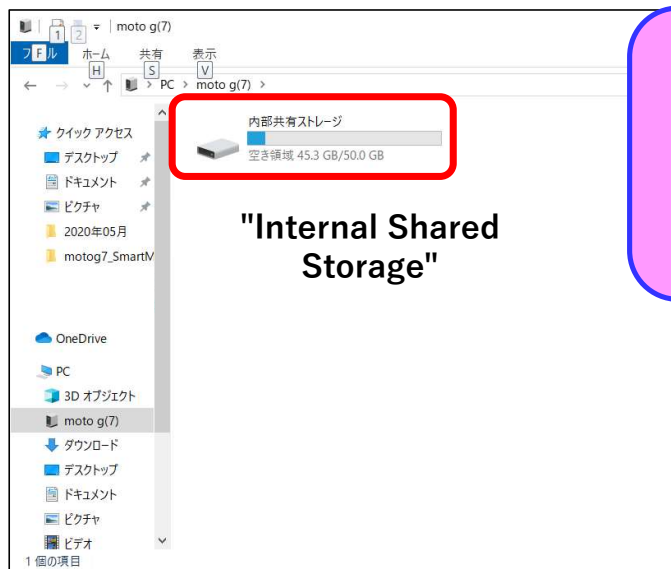

The folders to which each file is copied and pasted are limited to the following.

※Ver000006 or later

Internal shared storage  
/Android/data/jp.akt.rtfsetting/files

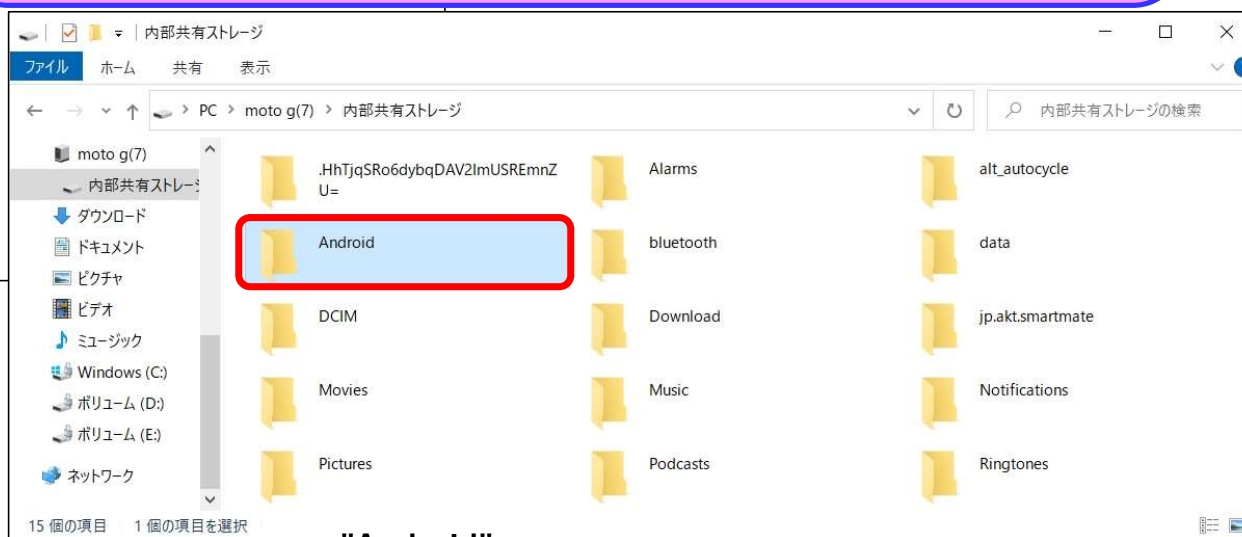

>"Android"

## 10-1-3. Pre-registration of base station coordinates

Migrate the created files to the Android device to be used.

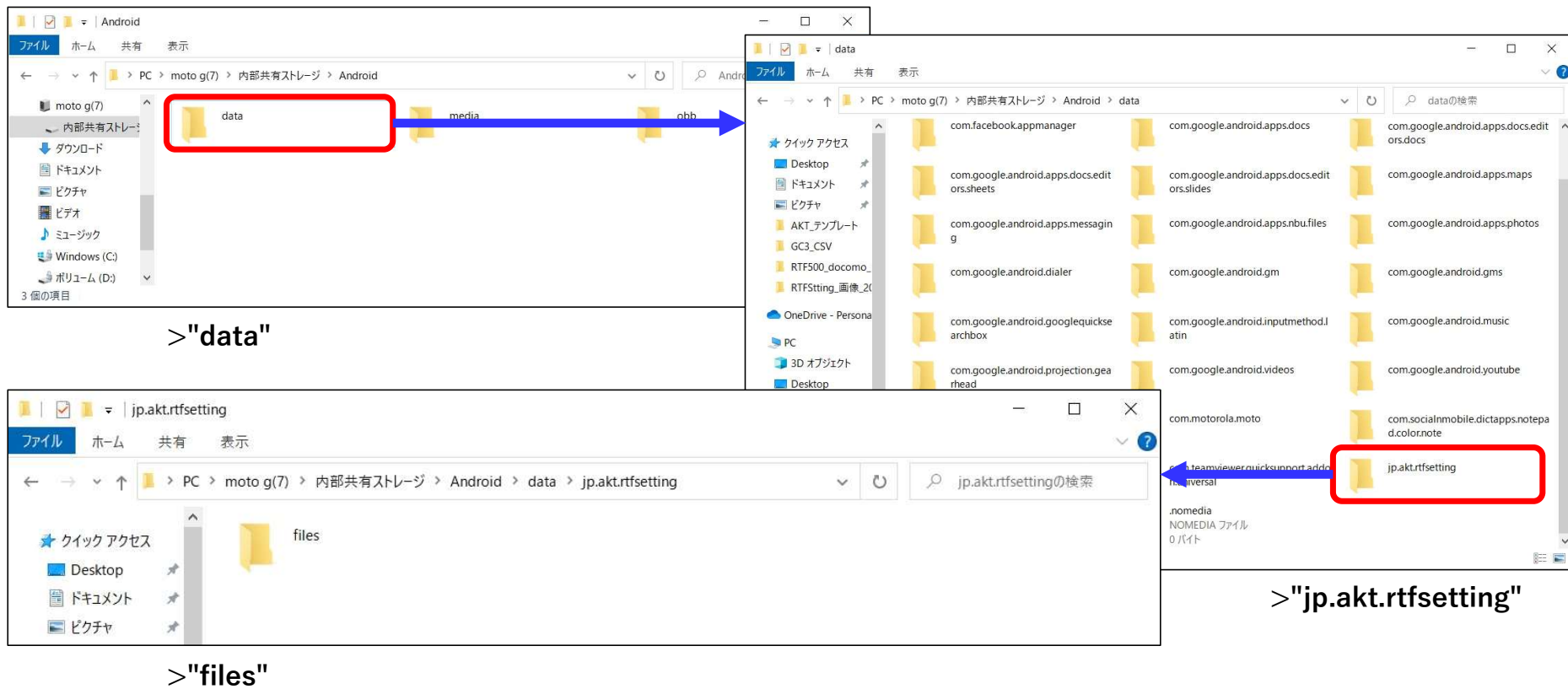

## 10-1-3. Pre-registration of base station coordinates

Migrate the created files to the Android device to be used.



Open the files folder.

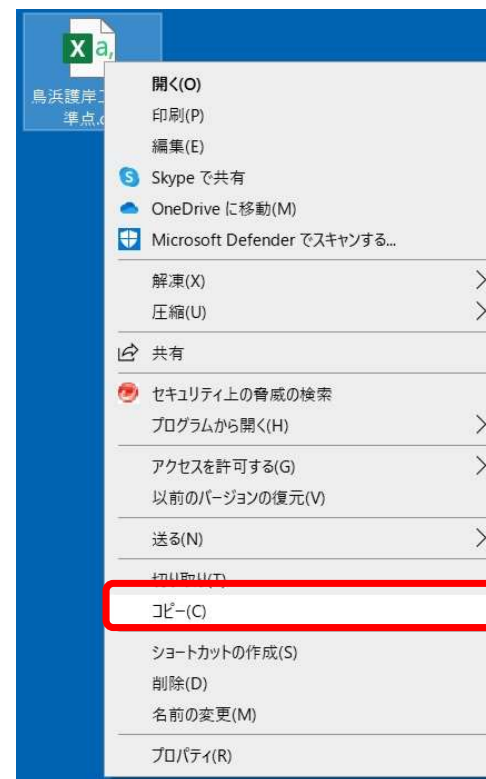

Copy the CSV file you created on your computer.

## 10-1-3. Pre-registration of base station coordinates

Migrate the created files to the Android device to be used.

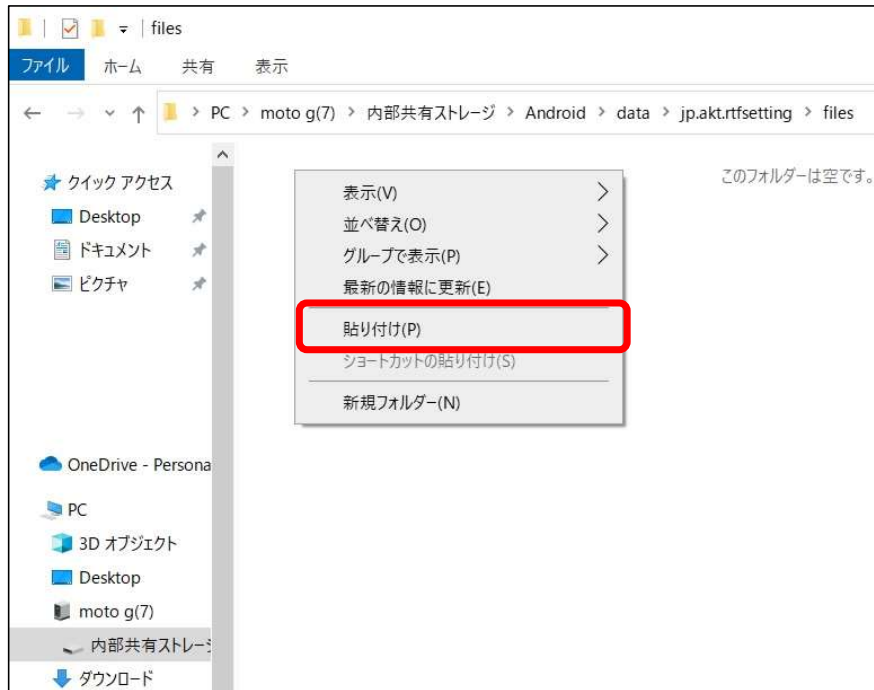

Paste in the "files" folder

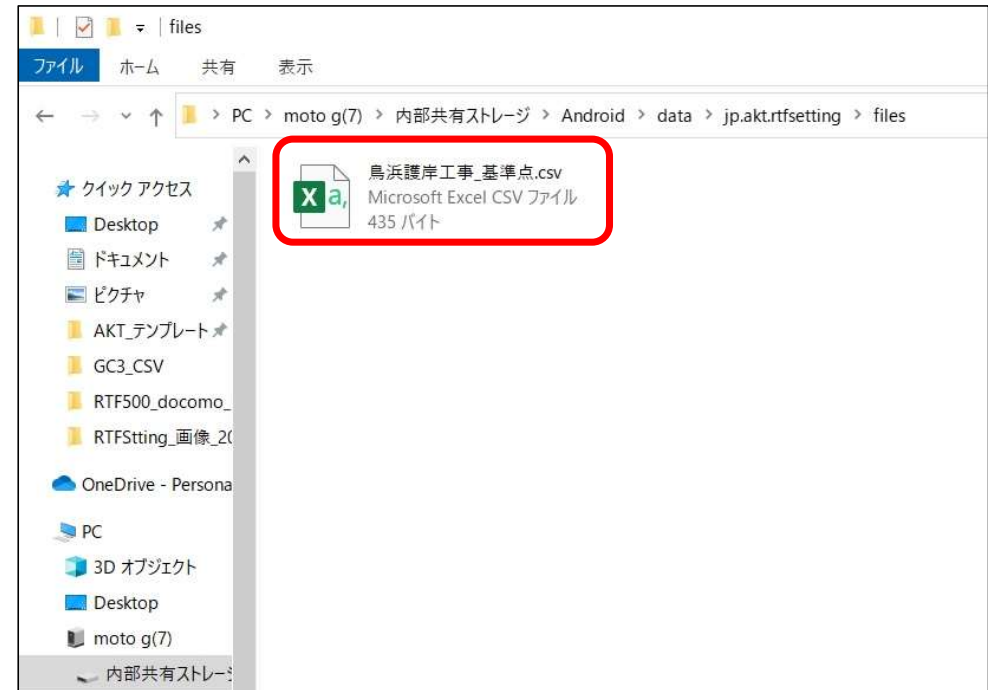

Verify that the file was transferred.

## 10-1-3. Pre-registration of base station coordinates

### Checking Migrated Reference Coordinates

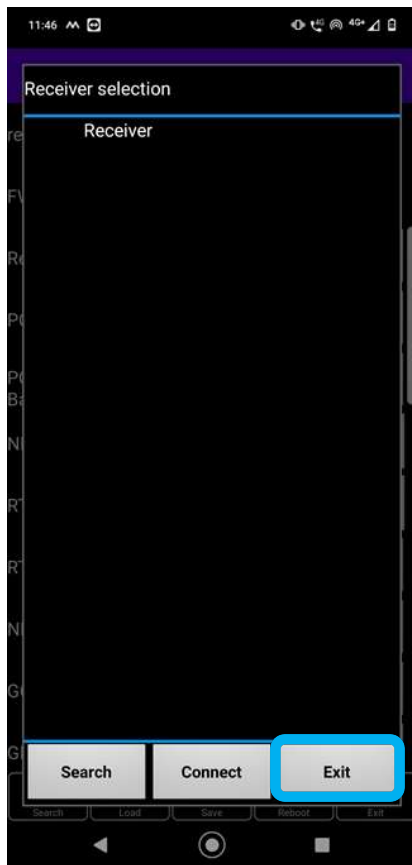

It is not necessary to connect to a GNSS receiver to check the reading of the base station coordinates.

Launch the RTFSetting.

Tap Exit.

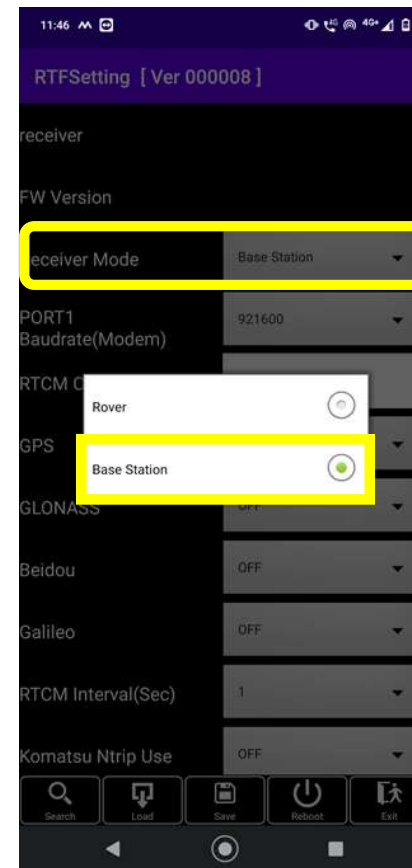

Tap "Receiver Mode" and then

Tap Base Station.

# 10-1-3. Pre-registration of base station coordinates

## Checking Migrated Reference Coordinates

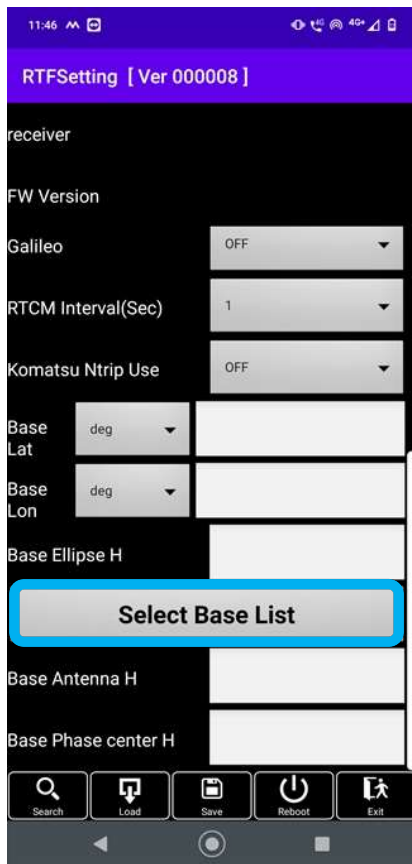

Tap "Select Base List"

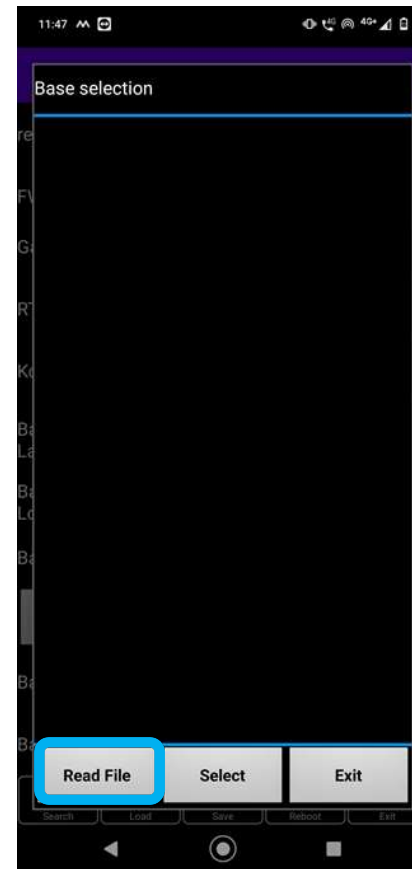

Tap "Read File"

## 10-1-3. Pre-registration of base station coordinates

### Checking Migrated Reference Coordinates



The reference point coordinate file migrated to internal shared storage/Android/data/jp.akt.rtfsetting/files is displayed.

Tap the “\*.csv” that is read and displayed.



The reference point coordinates that have been read are displayed.

Confirm and tap "Exit".



## 10-1-3. Pre-registration of base station coordinates

### Checking Migrated Reference Coordinates

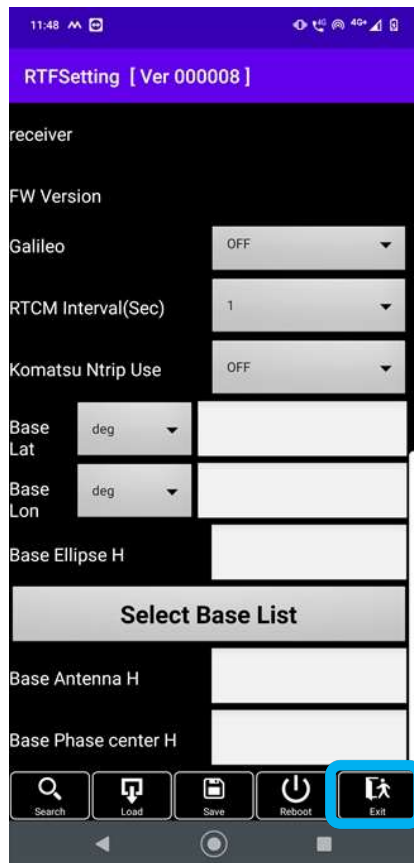

Tap "Exit" to exit the application

# 10-1-4 Base station Setup

10-1-4-1. Using an "external radio" with the base station

# 10-1-4-1. Using an "external radio" with the base station

## (1) RTK-GNSS using an "external radio" with a base station "SC Rover"

▶ Rover "SC Rover" uses "SmartMate"

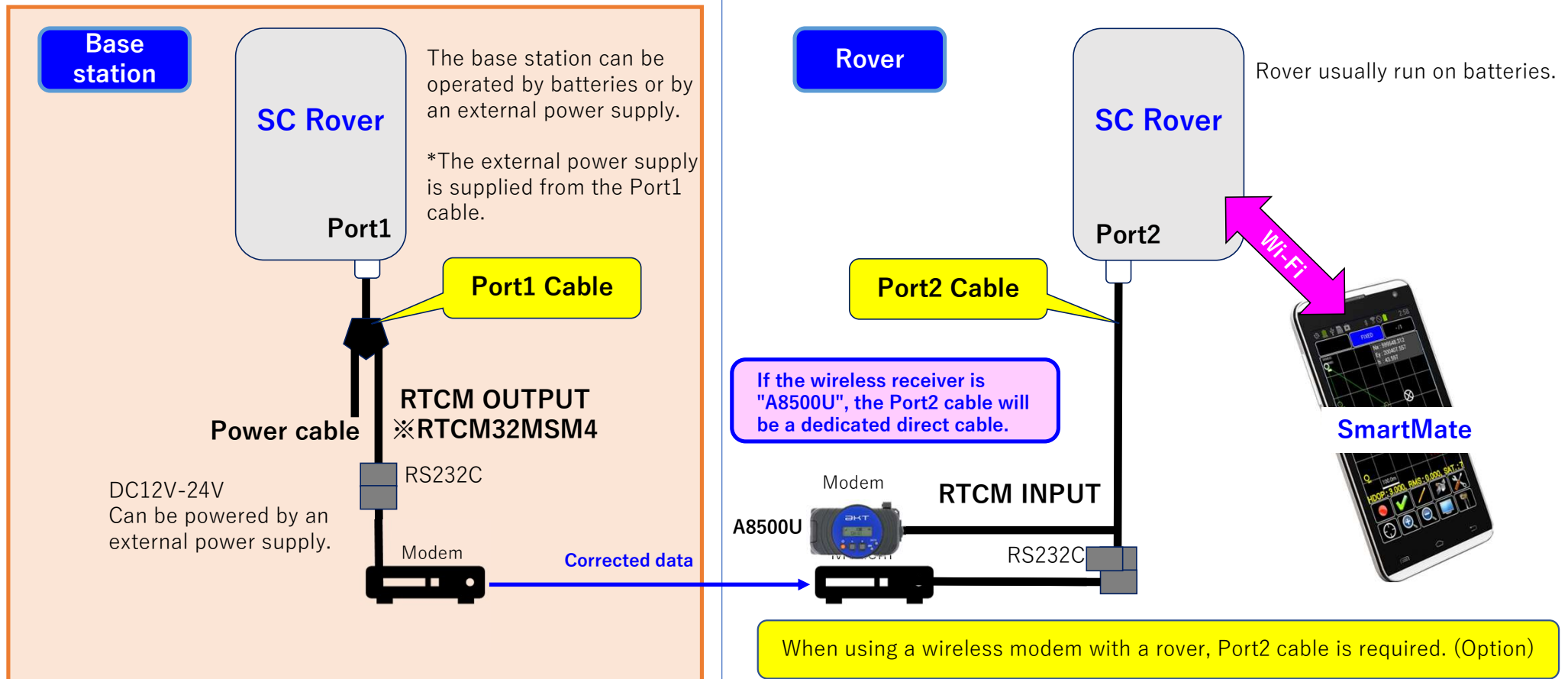

# 10-1-4-1. Using an "external radio" with the base station

## (2) RTK-GNSS using "external radio" with the base station "SCRover" installed.

▶ rover "retrofit kit, i-Construction Equipment (Type 11: MC-i4)"

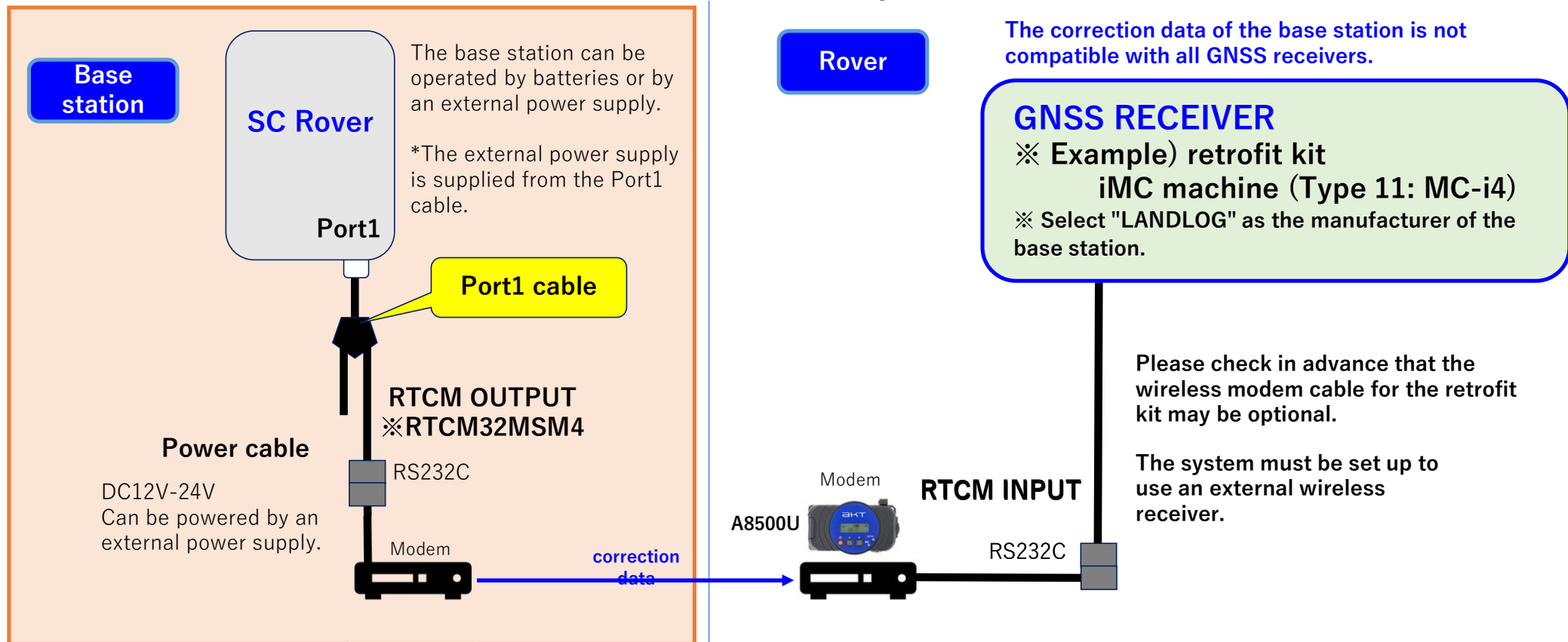

# 10-1-4-1. Using an "external radio" with the base station

After connecting to Receiver

See Chapter 9

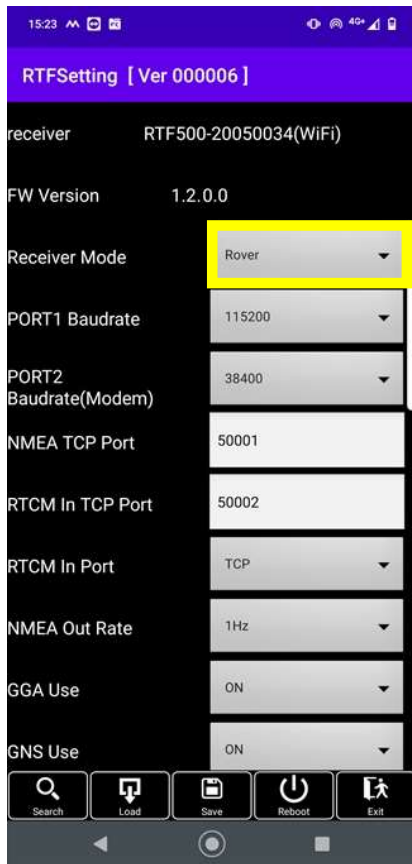

Tap "Receiver Mode"

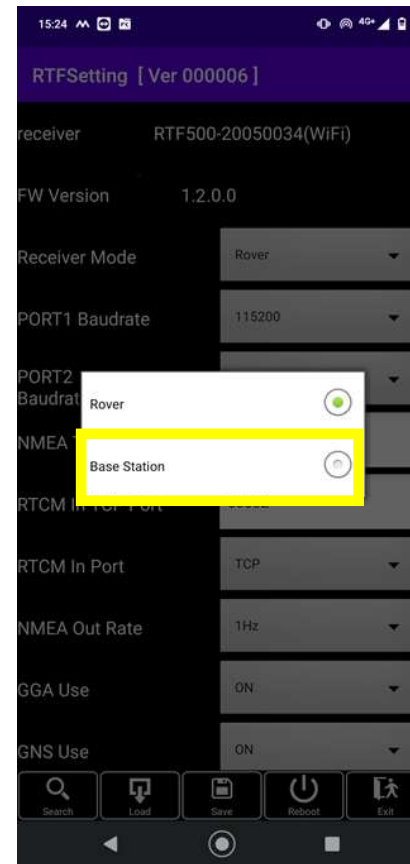

Select "Base Station" and tap.

# 10-1-4-1. Using an "external radio" with the base station

## Use the base station "external radio"

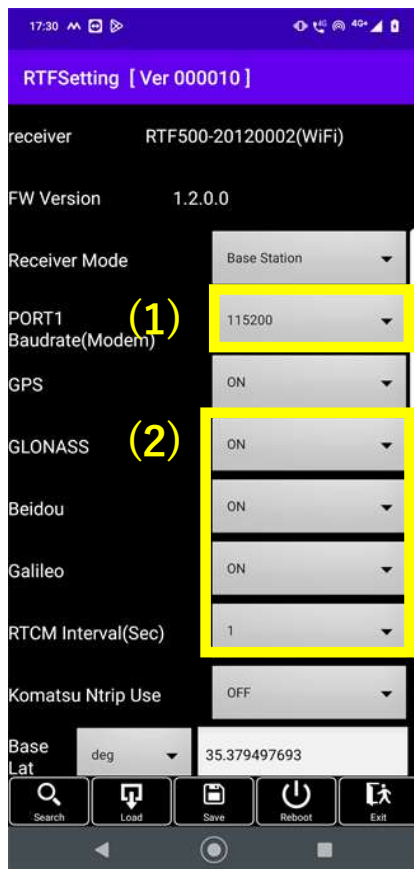

(1) "PORT1 Baudrate(Modem)" Select the baud rate(communication speed) of the wireless device to be used.

(2) Turn on the satellite group to be used. Select the satellite group according to the specifications of the external radio used. See \*10-1-1.

When using "SC Rover" as a base station with an external radio, the correction data to be transmitted is fixed to "RTCM32MSM4".

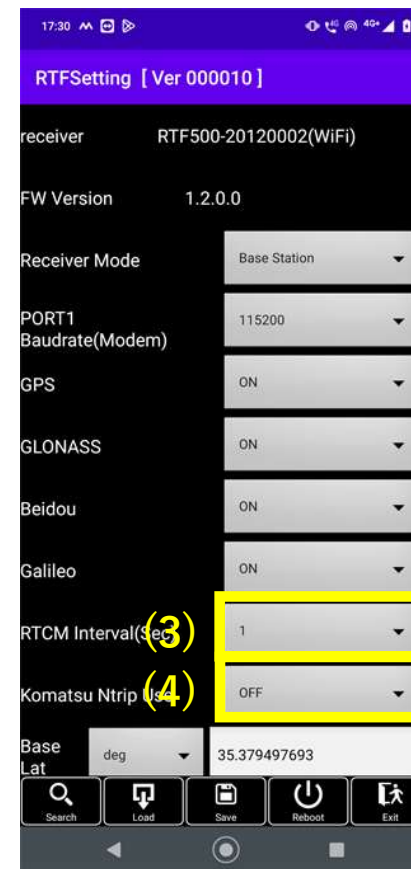

(3) "RTCM Interval(sec)" "RTCM Interval(sec)" Sets the transmission interval of correction data transmitted from the base station. \* "1" is the default. "It cannot be changed in Ver000010." As of November 2022

(4) "Komatsu Ntrip Used" If you use an external wireless modem, be sure to turn it off.

# 10-1-4-1. Using an "external radio" with the base station

## Use the base station "external radio"

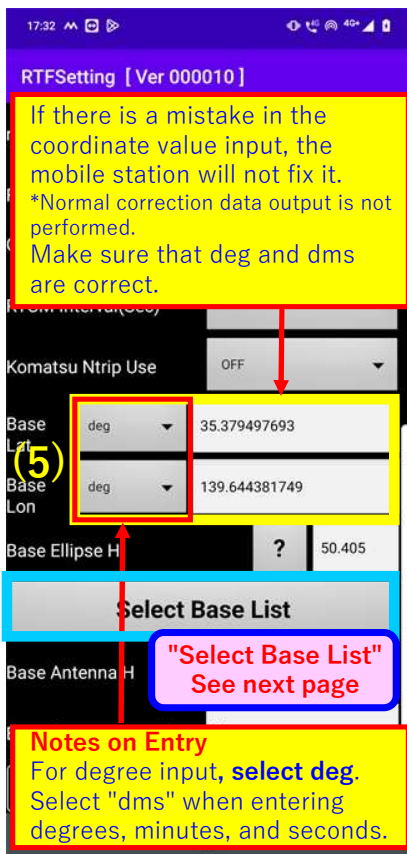

(5) Enter the coordinates of the base station.

**Base Lat**=Enter the latitude.  
**Enter Base Lon**=longitude.  
※ Latitude: South adds (-) to Head  
※ Longitude: West adds (-) to Head

**Enter in deg (degrees) or dms (degrees minutes seconds).**

- **deg**= degree input
  - **dms**= degrees, minutes, seconds  
d=degree, m= minute, s=second
- **deg (degrees) [decimal] example**  
Latitude: 35.1508955145  
Longitude: 135.1348706894  
※ Please enter at least 9 digits after the decimal point in the deg input

■ **dms (degrees, minutes, seconds) [60th] Example**

Latitude: 35 degrees 9 minutes 3.22385  
dd mm ss.sssss  
35 09 03.22385

Longitude: 135 degrees 8 minutes 5.53448  
ddd mm ss.sssss  
135 08 05.53448

\* Please enter at least 4 digits or more after the decimal point in the dms input.

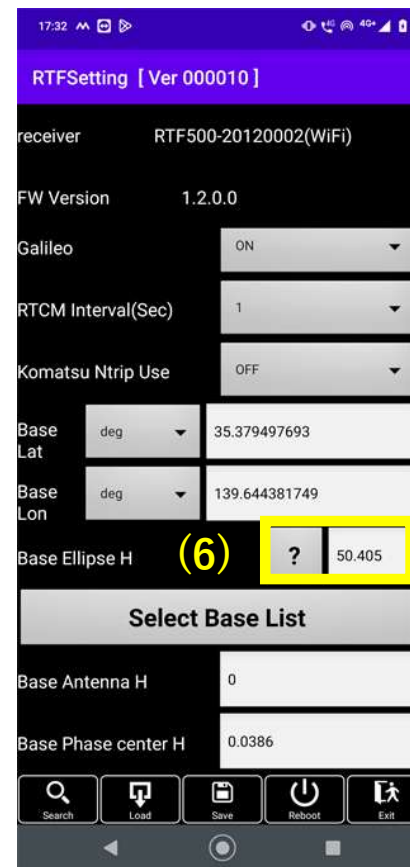

(6)

**Base Ellipse H: Ellipsoidal height (m)**  
Enter the ellipsoid height (ground height).

Press the? Button, the height input method for

- Base Ellipse H
  - Base Antenna H
  - Base Phase center H
- are displayed.

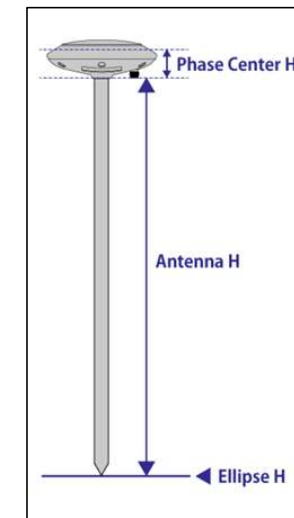

# 10-1-4-1. Using an "external radio" with the base station

## Use the base station "external radio"

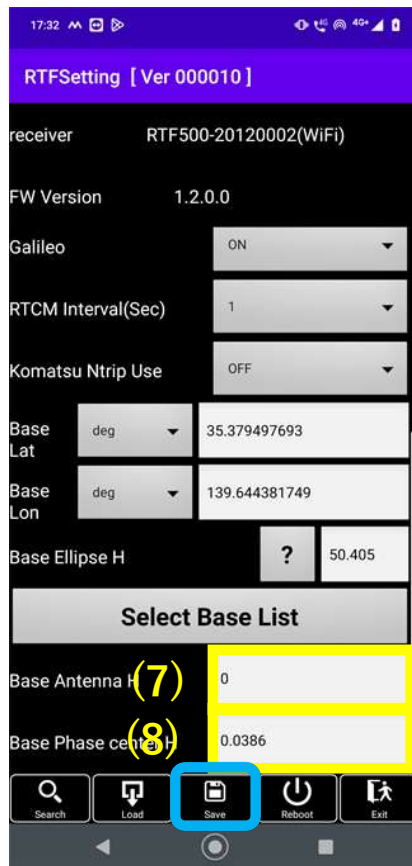

(7)  
**Base Antenna H=Antenna Height (m)**  
\*Enter the height from the reference point to the bottom of the antenna.

(8)  
**Base Phase Center = Antenna Phase Center Height (m)**  
"0.0386" input

\*The phase center height of the "AR270" antenna in the normal set is "0.0386" m from the bottom of the antenna.  
\*If an antenna other than AR270 is used, enter the phase center height of that antenna.

Check and Tap Save.

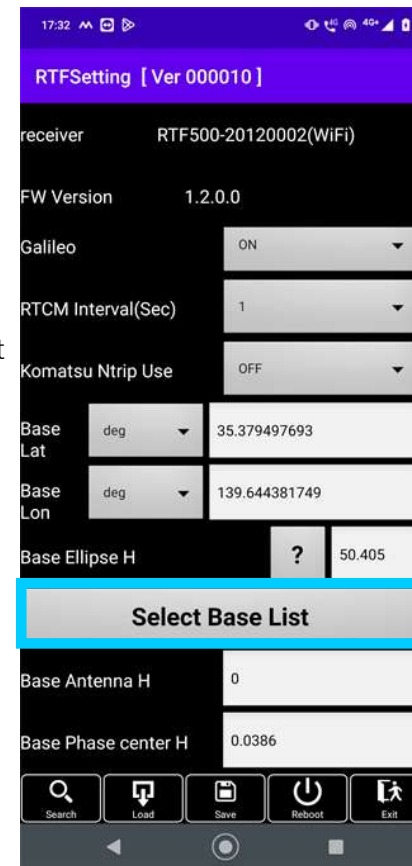

### ■ "Select Base List"

You can select the coordinates of a reference point that has been registered in a file in advance.

\*Refer to ["10-1-3. Pre-registration of base station Coordinates"](#)

Select Base List.  
Tap.



## 10-1-4-1. Using an "external radio" with the base station

### Use the base station "external radio"

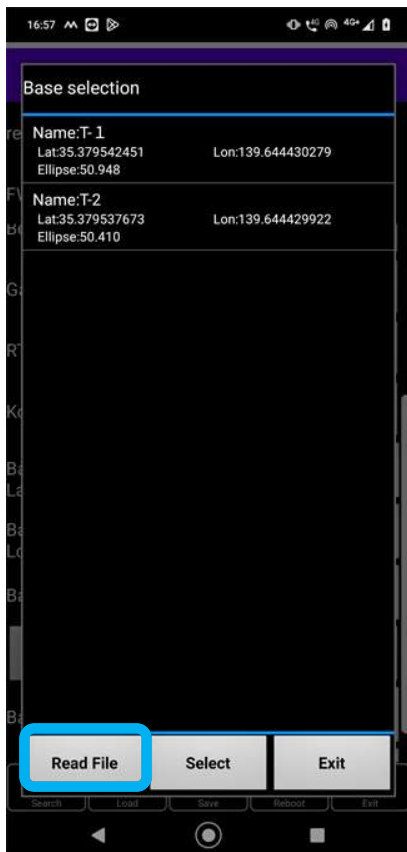

If already loaded, a list of reference coordinates will be displayed.

Read File.  
Tap.



Migrated reference point coordinate files are displayed in the internal shared storage /Android/data/jp.akt.rtfsetting/files. read-displayed

Tap the "\*.csv" that appears on the import screen.

# 10-1-4-1. Using an "external radio" with the base station

## Use the base station "external radio"

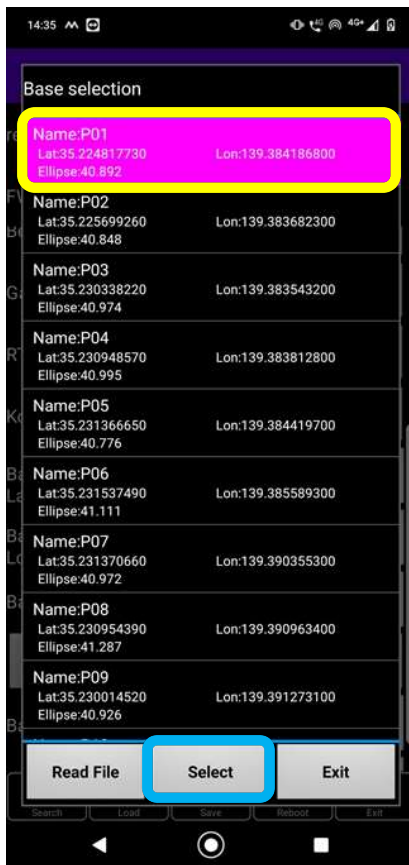

The reference point coordinates that have been read are displayed.

Tap the base station coordinate point to be installed, and tap "Select".

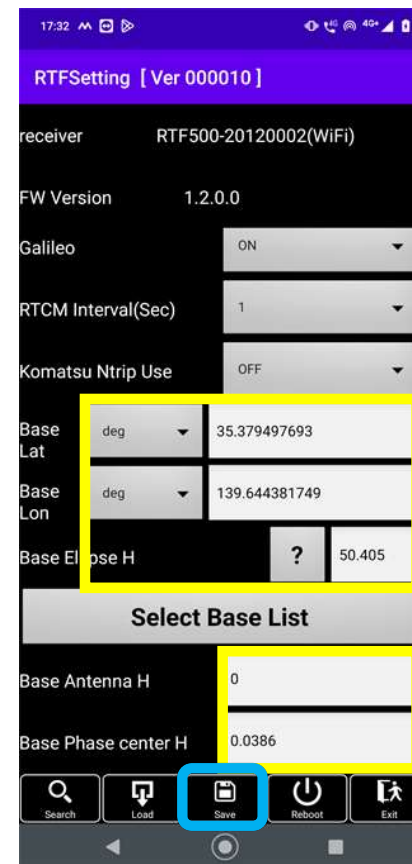

The coordinates of the selected reference point are reflected.

Check  
• Base Antenna H  
• Base Phase center H  
And tap Save.

# 10-1-4-1. Using an "external radio" with the base station

## Use the base station "external radio"

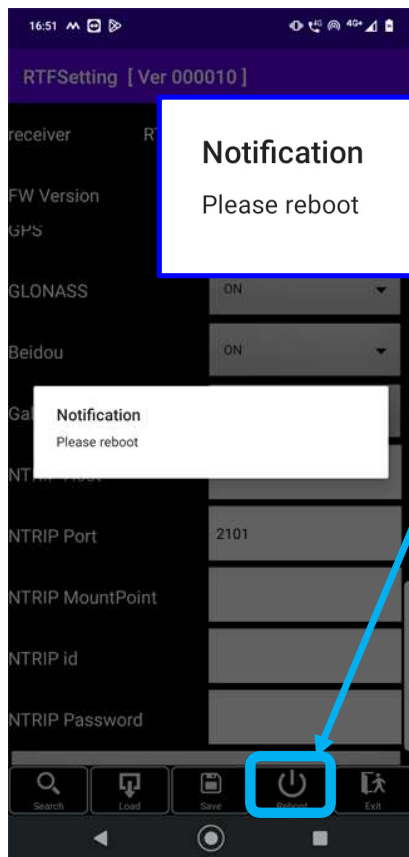

If the write succeeds, the above message will be displayed.

Tap Reboot.

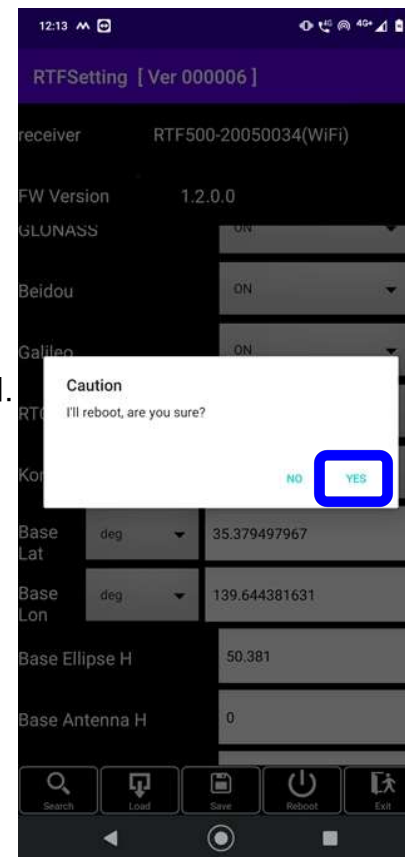

After tapping "Reboot",

Tap "YES".

The receiver power is OFF.

## 10-1-4-1. Using an "external radio" with the base station

### Use the base station "external radio"

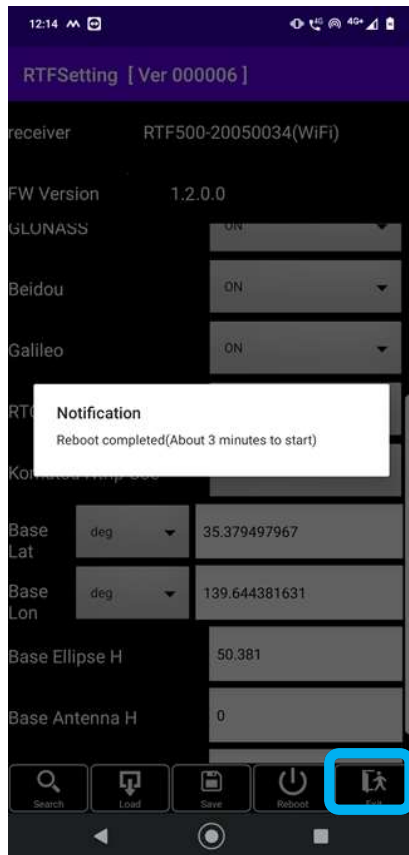

Tap "Exit" to exit the app.

"Reboot" turns off the receiver's power supply

- When using batteries, press the power button to turn on and start to reflect the settings.
- When external power is supplied, the power is automatically turned on and the setting is reflected.

After that, even if the power of the GNSS receiver is turned off, it will start up with the same settings until the settings are changed.

# 10-1-4-1. Using an "external radio" with the base station

## Use the base station "external radio"



### ■ Normal operation

**BATT** : Lit red (using external power supply)

Lights green (using batteries)

**GNSS**: lit

**Wi-Fi**: Flashing

**BT**: Flashing

→ Ready to use.

**critical  
confir  
mation**

Make sure that the PORT1 cable and radio transmitter are connected.

- Verify that the power to the wireless transmitter is ON.
- Check the transmit channel (CH).
- Verify that the wireless transmitter is transmitting the data.

※ The transmission state of the wireless transmitter used is different for each manufacturer, please check the instruction manual etc.

Example) • **ALINCO** • **XETPD1**:

→ "P" flashes or lights up on the indicator.

• **Lecuo STANDARD** • **U7000UJC181**:

→ "TL", "TM", etc. are displayed on the main panel.

\*Communication is not possible if the transmitter and receiver have different channels.

\*The setting of the radio transmitter cannot normally be changed if the data cable between the GNSS receiver and the radio transmitter is connected while correction data is being sent from the GNSS receiver. (Settings cannot be changed if there is data input to the radio transmitter.)

→ When changing settings (CH change, etc.), disconnect the data cable between the GNSS receiver and wireless transmitter, change the settings of the wireless transmitter, and reconnect the data cable after changing the settings.

▶ **If the coordinates input at the time of setting the base station are greatly different from the actual coordinates, the base station GNSS receiver will not output correction data normally.** ※ If the base station receives a coordinate that is different from the actual coordinate and is sent, the rover will not be FIX.

▶ **About transmission output of radio transmitter**

In a normal digital radio transmitter, the transmitter output can be selected.

\*Normally, 1W (L), 2W (M), and 5W (H) are selected.

When transmitting at 5W (H), there is a high possibility of thermal runaway of the transmitter itself, so It is recommended to set the transmitter to 1W (L) or 2W (M). (Normally 1W)

※ Please refer to the instruction manual of each manufacturer for the setting method.

# 10-1-4 Base station Setup

10-1-4-2. Using the “Komatsu Ntrip Caster” with the base station



## 10-1-4-2. Using the “Komatsu Ntrip Caster” with the base station

### About Connecting the "SC Rover" base station to Komatsu Ntrip Caster

Base  
station

You must purchase a license in advance  
Make sure that the Komatsu Ntrip Caster license is enabled.



When using "Komatsu Ntrip Caster" at the base station, if the WiFi light of the GNSS receiver is off, no correction data is being sent from the GNSS receiver in use.

**Important:** When using "Komatsu Ntrip Caster", turn on the power of the communication terminal and confirm that the communication terminal has started up before turning on the power of "SC Rover".

When using "Komatsu Ntrip Caster" at the base station, license authentication is confirmed with the Komatsu Ntrip Caster server when the GNSS receiver is started.

If the communication terminal is not connected to the Internet when the GNSS receiver is started, authentication cannot be confirmed even if the license is purchased and the receiver is set. The lamp goes out.

\*In this case, the correction data of the base station will not be distributed.

If the WiFi lamp is off at startup even though you have purchased a license and already confirmed authentication, check that the communication terminal has started and communication has been established, then connect the GNSS receiver. Please turn off the power and turn it on again.



## 10-1-4-2. Using the "Komatsu Ntrip Caster" with the base station

### (1) RTK-GNSS using "Komatsu Ntrip Caster" with the base station "SC Rover"

#### ► Using SmartMate with mobile station "SC Rover"

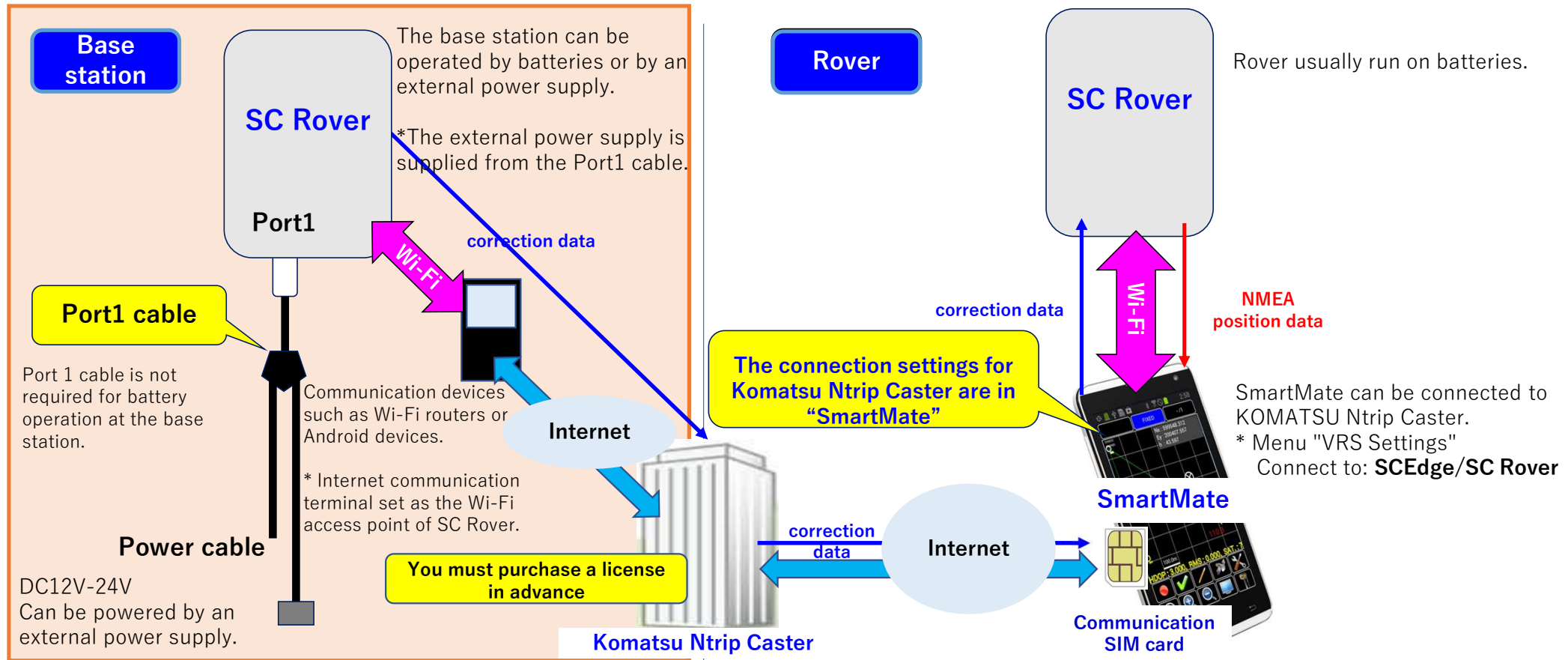



## 10-1-4-2. Using the “Komatsu Ntrip Caster” with the base station

After connecting to Receiver

See Chapter 9

When using “Komatsu Ntrip Caster” at the base station, it is necessary to purchase a license in advance.

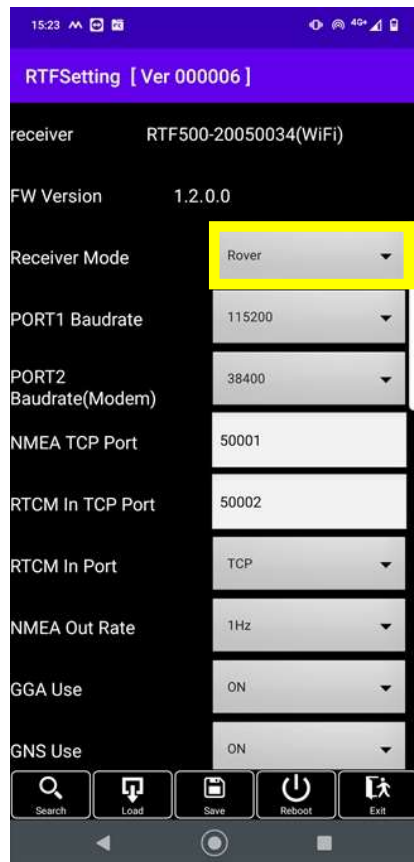

"Receiver Mode"  
Tap.

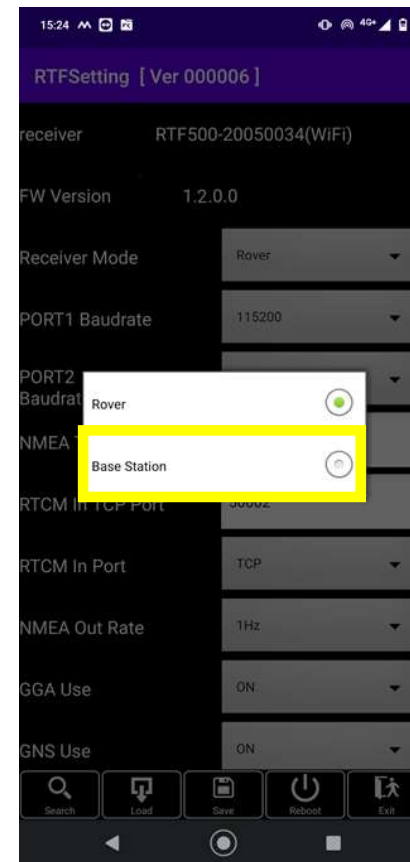

"Base Station"  
Select and tap.

## 10-1-4-2. Using the “Komatsu Ntrip Caster” with the base station

### Using “Komatsu Ntrip Caster” with the base station

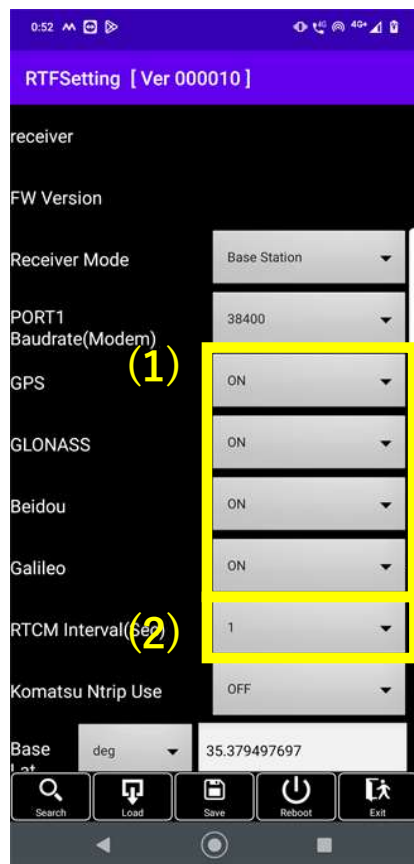

(1)  
Set the satellite group to be used to "ON".  
• Basically, set all to "ON".

(2)  
"RTCM Interval(sec)"  
Set the transmission interval of correction data transmitted from the base station.  
\* "1" is the default.  
"It cannot be changed in Ver000010."  
As of November 2022

When using NtripCaster with "SC Rover" as the base station, the correction wave to be transmitted is "RTCM32MSM7"

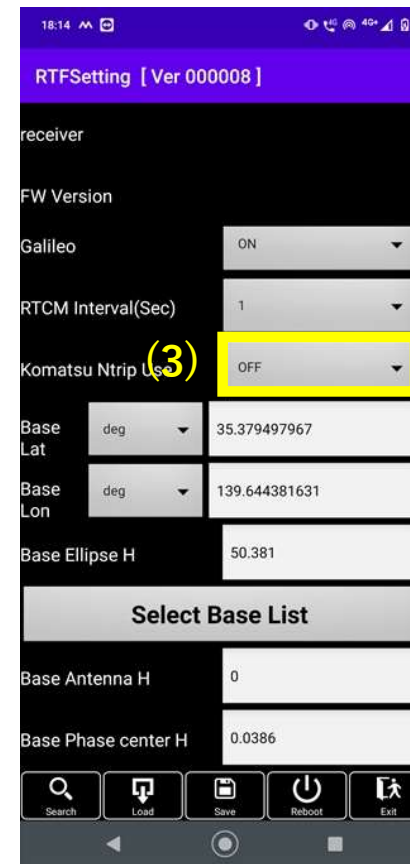

(3)  
Komatsu Ntrip Use  
Tap.

## 10-1-4-2. Using the “Komatsu Ntrip Caster” with the base station

### Using “Komatsu Ntrip Caster” with the base station

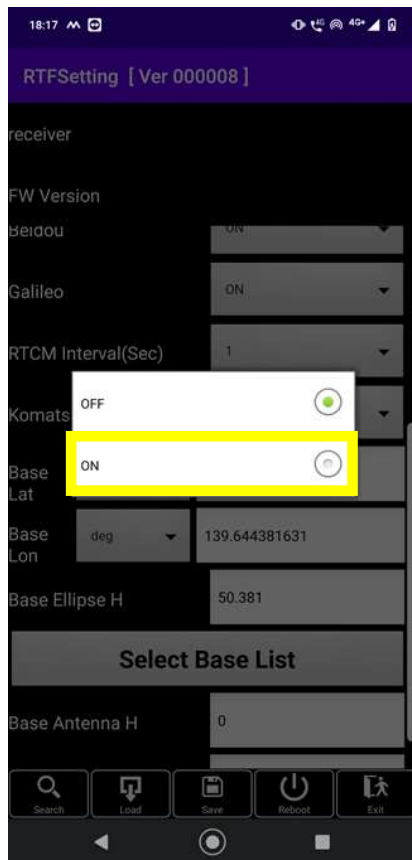

"ON"  
Tap.



(4)  
Komatsu Ntrip Host  
Tap.

## 10-1-4-2. Using the “Komatsu Ntrip Caster” with the base station

### Using “Komatsu Ntrip Caster” with the base station



New Server  
Select.



(5)  
Select Authentication.

## 10-1-4-2. Using the “Komatsu Ntrip Caster” with the base station

### Using “Komatsu Ntrip Caster” with the base station

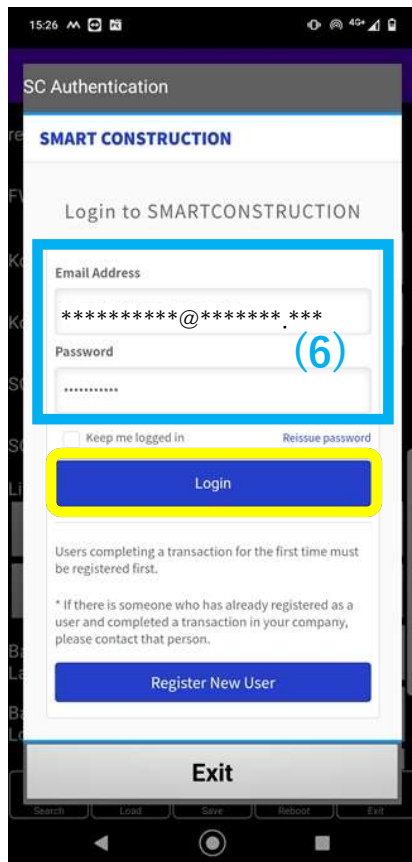

(6)  
Enter the email address and password you used when purchasing the license.

Tap "Login"

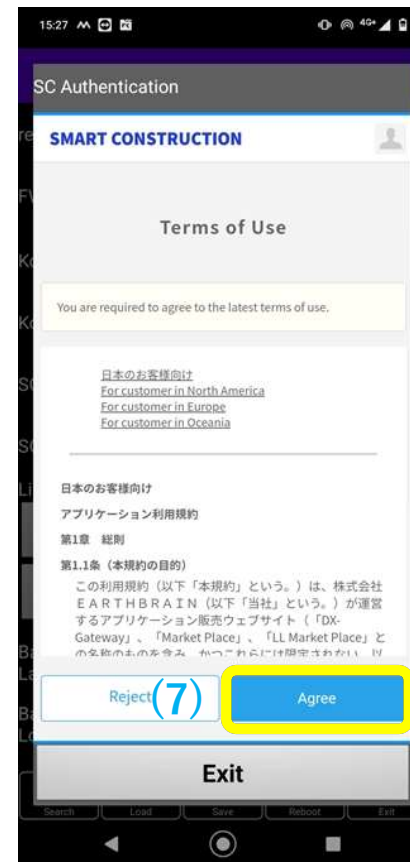

(7)  
When the terms of use are displayed, confirm the terms of use and tap "Agree"

## 10-1-4-2. Using the “Komatsu Ntrip Caster” with the base station

### Using “Komatsu Ntrip Caster” with the base station

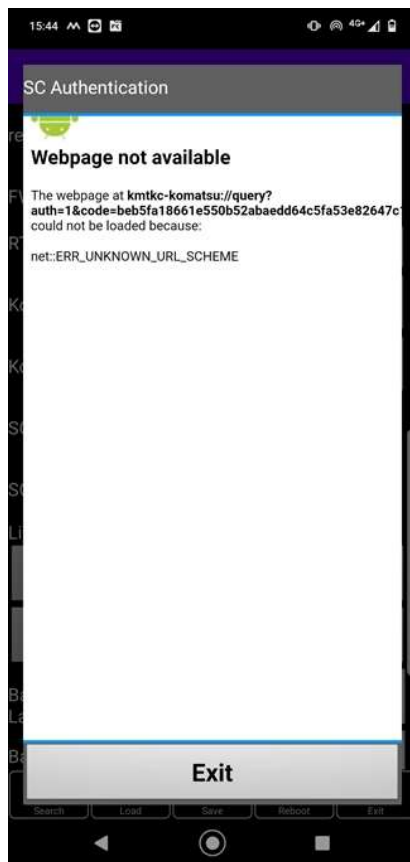

Authentication is performed.

The screen disappears after a short time.



(8)

After successful authentication SC Company and SC User at the time of license purchase are displayed and “License status” becomes “OK”.  
\*If "NG" is displayed, it is not authenticated.

When “License status” becomes “OK”, the serial number “SC Rover” can be used as a base station with Komatsu Ntrip Caster.

\* If "NG", it is not certified.  
Please check if the license was purchased correctly.



# 10-1-4-2. Using the “Komatsu Ntrip Caster” with the base station

## Using “Komatsu Ntrip Caster” with the base station

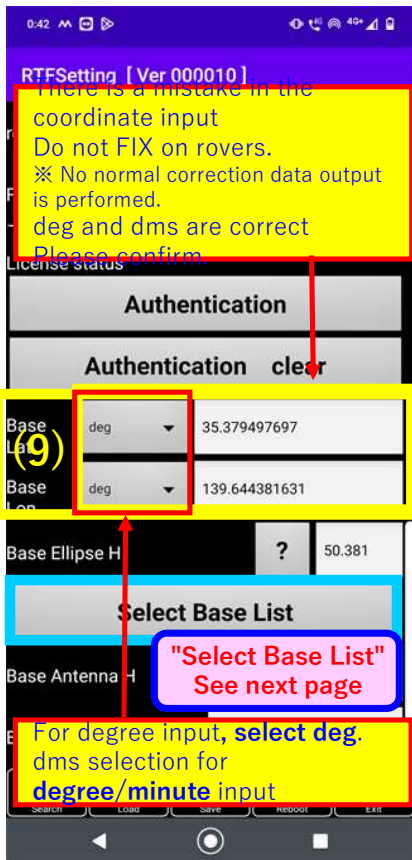

(9)

Enter the coordinates of the base station.

**Base Lat**=Enter the latitude.

**Enter** Base Lon=longitude.

※ Latitude: South adds (-) to Head

※ Longitude: West adds (-) to Head

Enter in deg (degrees) or dms (degrees minutes seconds).

- deg= degree input
- dms= degrees, minutes, seconds  
d=degree, m= minute, s=second

■ Example of input in deg (degree) [decimal system

Latitude: 35.1508955145

Longitude: 135.1348706894

\*Please enter at least 9 digits after the decimal point in the deg input.

■ dms (degree minutes and seconds) [60 decimal system] input example

Latitude: 35 degrees 9 minutes 3.22385

dd mm ss.sssss

35|09|03.22385

Longitude: 135 degrees 8 minutes 5.53448

ddd mm ss.sssss

135|08|05.53448

\* Please enter at least 4 digits or more after the decimal point in the dms input.

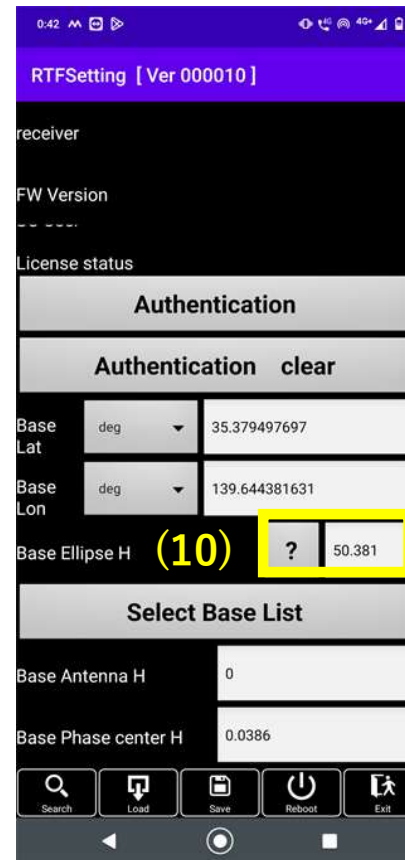

(10)

**Base Ellipse H: Ellipsoidal height (m)**

Enter the ellipsoid height (ground height).

Press the? Button,

- Base Ellipse H
- Base Antenna H
- Base Phase center H

will displays how to enter height for.

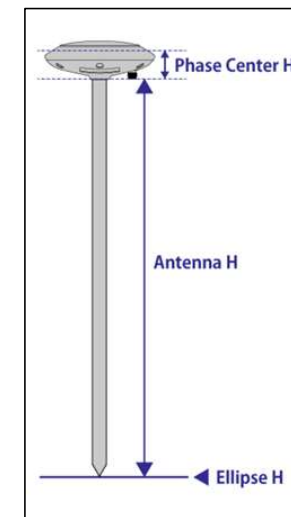

## 10-1-4-2. Using the “Komatsu Ntrip Caster” with the base station

### Using “Komatsu Ntrip Caster” with the base station

0:42 RTFSetting [ Ver 000010 ]

receiver

FW Version

License status

Authentication

Authentication clear

Base Lat deg 35.379497697

Base Lon deg 139.644381631

Base Ellipse H ? 50.381

Select Base List

Base Antenna H (11) 0

Base Phase center H (12) 0.0386

Search Load Save Reboot Exit

(11)  
**Base Antenna H=Antenna Height (m)**  
\*Enter the height from the reference point to the bottom of the antenna.

(12)  
**Base Phase Center = Antenna Phase Center Height (m)**  
"0.0386" input  
\*Normal set  
The phase center height of the "AR270" antenna is "0.0386" m from the bottom of the antenna.  
\*If an antenna other than AR270 is used, enter the phase center height of that antenna.

Check and Tap "Save".

0:42 RTFSetting [ Ver 000010 ]

receiver

FW Version

License status

Authentication

Authentication clear

Base Lat deg 35.379497697

Base Lon deg 139.644381631

Base Ellipse H ? 50.381

Select Base List

Base Antenna H 0

Base Phase center H 0.0386

Search Load Save Reboot Exit

■ "Select Base List"  
You can select the reference point coordinates registered in the file in advance.  
\*Refer to "10-1-3. Pre-registration of base station Coordinates"

Select Base List. Tap.

## 10-1-4-2. Using the “Komatsu Ntrip Caster” with the base station

### Using “Komatsu Ntrip Caster” with the base station

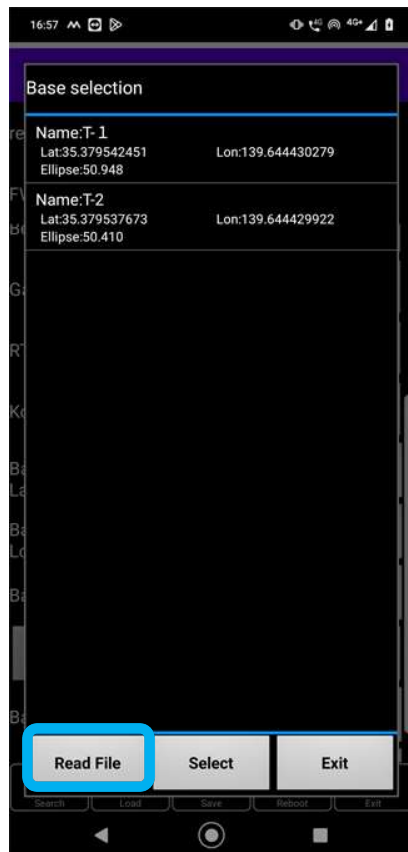

If you have already read, the reference coordinate list will be displayed.

“Read File”  
Tap.



The reference point coordinate file migrated to internal shared storage/Android/data/jp.akt.rtfsetting/files is displayed.

Tap the “\*.csv” that is read and displayed.

## 10-1-4-2. Using the “Komatsu Ntrip Caster” with the base station

### Using “Komatsu Ntrip Caster” with the base station



The reference point coordinates that have been read are displayed.

Tap the base station coordinate point to be installed, and tap "Select".

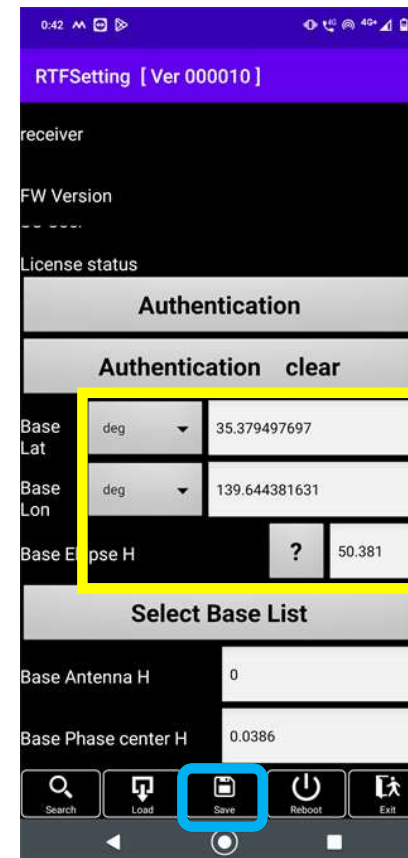

of the selected origin  
The coordinates are reflected.

Check  
• Base Antenna H  
• Base Phase center H  
and tap “Save”.

## 10-1-4-2. Using the “Komatsu Ntrip Caster” with the base station

### Using “Komatsu Ntrip Caster” with the base station

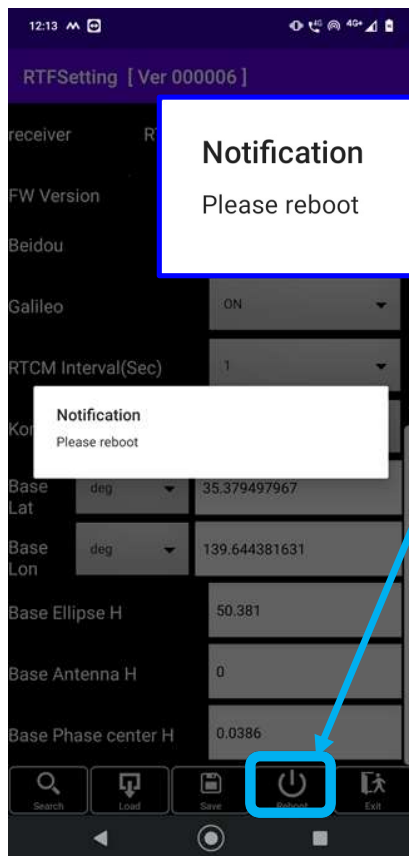

Notification  
Please reboot

Notification  
Please reboot

If the write succeeds,  
above message will be displayed.

Tap Reboot.

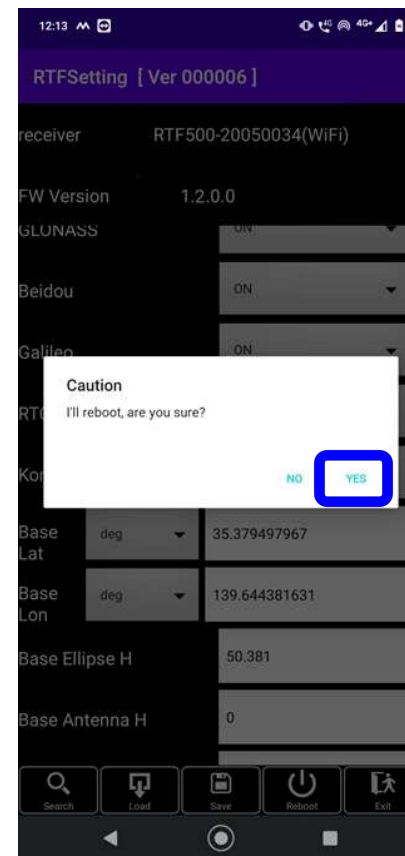

Caution  
I'll reboot, are you sure?

NO YES

After tapping Reboot, tap YES.

Receiver power will be turned off.

## 10-1-4-2. Using the “Komatsu Ntrip Caster” with the base station

### Using “Komatsu Ntrip Caster” with the base station

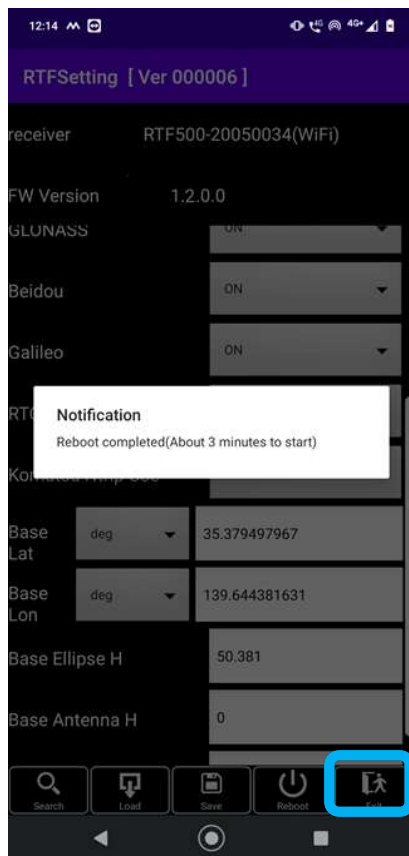

Tap "Exit" to exit the app.

"Reboot" will turn off the power of the receiver.

- When using batteries, press the power button to turn on and start to reflect the settings.
- When external power is supplied, the power is automatically turned on and the setting is reflected.

After that, even if the power of the GNSS receiver is turned off, it will start up with the same settings until the settings are changed.

## 10-1-4-2. Using the “Komatsu Ntrip Caster” with the base station

### Using “Komatsu Ntrip Caster” with the base station



#### ■ Receiver lamp

**BATT** : Lit red (using external power supply)  
Lights green (using batteries)

**GNSS** : Lit

**WiFi** : lit

**BT** : Flashing

If it is in the above state, it is operating normally.

\*If GNSS is blinking, GNSS satellites are not being received properly

If the **WiFi is "lit"**, it is connected to the Ntrip Caster Server and sending correction data.

If the **WiFi is "off"**, no correction data has been sent.

▮ Make sure that the Komatsu Ntrip Caster license is valid (OK).

▮ Turn on the power of the SC Rover receiver while the communication terminal is connected to the Internet.

\* Server authentication with Ntrip Caster Server is performed when SC Rover is started.

If the SC Rover receiver is turned on while the communication terminal is not connected to the Internet, the WiFi lamp will turn off because Server authentication will not be performed and correction data will not be sent.

Also, if the communication terminal and SC Rover receiver are not connected to WiFi, the WiFi lamp will turn off because the correction data will not be sent.

If the power of the base station is turned off, the next time it starts up, Make sure the communication terminal is turned on and running, Turn on the GNSS receiver.

## 10-1-4-2. Using the “Komatsu Ntrip Caster” with the base station

### Using “Komatsu Ntrip Caster” with the base station



#### ■ Receiver lamp

BATT : Lit red (using external power supply)  
Lights green (using batteries)

GNSS : Lit

WiFi : lit

BT : Flashing

If it is in the above state, it is operating normally.

When the WiFi of the base station is "lit" and the correction wave is received by the mobile station, but the mobile station remains "SGPS" and does not become "FIX"

Check that the rover's ID and PASS are correct.

Destination, ID, PASS is not wrong

If the coordinates (latitude, longitude, height of the ellipsoid) input at the time of setting the base station are greatly different from the actual coordinates, the base station SC Rover will not output correction data normally.

**Check the input coordinates of the base station.**

**\*Confirm that the selection of deg (degree) [decimal system] and dms (degree minutes and seconds) [60 decimal system], input values, etc. are correct.**



# 10-2. Rover Setup

## Rover

## 10-2-1. "SC Rover" rover RTK reception correction data

■ The correction data that can be RTK received and analyzed by the "SC Rover" mobile station is as follows.

- RTCM3.0 · 3.1 (GPS/GLONASS) **Not supported for RTCM3.2 MSM3**
- RTCM3.2 MSM4/MSM5/MSM7 (Multi-GPS/GLONASS/GEIDOU/GALILEO Support)

\*QZSS is not used for analysis.

**\*Other correction data formats such as CMR/CMR+/CMRx cannot be received.**

■ "SC Rover" When using an external radio device on a rover, correction data is received by the receiver Port 2.

**\*A Port2 cable (optional) is required to connect to a wireless receiver.**

■ If the base station is made by another manufacturer, even if correction data "RTCM3.0/3.1" and "RTCM3.2 MSM4/MSM5/MSM7" are sent, it may not be RTK "FIX" due to compatibility with manufacturer specifications.

## 10-2-2. "SC Rover" rover settings

Item	Setting Values and Descriptions
Receiver Mode	Select Rover.
PORT1 Baudrate	<b>Sets the communication speed of the PORT1 cable (RS232C).</b> NMEA (0183) set for output is output. Match the communication speed set in the application that captures NMEA (0183).
PORT2 Baudrate (Modem)	<b>Sets the communication speed of the PORT2 cable (RS232C).</b> <b>Used for RTK with radio equipment.</b> Please match the RS232C communication speed set by the radio. *Normally, it is "38400".
NMEA TCP Port	<b>50001</b> Port number for NMEA output to SmartMate. <b>Do not change.</b>
RTCM In TCP Port	<b>50002</b> Port number for inputting RTCM messages (RTK correction data) from SmartMate. <b>Do not change.</b>
RTCM In Port	Select the correction data input port. <ul style="list-style-type: none"> <li>• <b>PORT2: Select to use radio</b></li> <li>• <b>Bluetooth:</b> Select this option when using "GPMate" or other Akasakatec Select this option when using an application.</li> <li>• <b>TCP: Select to use Ntrip with SmartMate</b></li> <li>• <b>SBAS:</b> Select when using in DGPS mode with SBAS</li> <li>• <b>PORT1:</b> Select when using Akasaka Tech applications such as "GPMate".</li> </ul>

Item	Setting Values and Descriptions
RTCM In Port	<ul style="list-style-type: none"> <li>• <b>NTRIP:</b> Select when setting the connection destination for Ntrip (Ntrip Caster) to the receiver.</li> </ul>
NMEA Out Rate	Sets the output cycle of NMEA messages output to PORT1 or TCP port (50001) Choose from 1Hz, 5Hz, or 10Hz. <b>When outputting to a TCP port, it is usually 1Hz.</b> To output to RORT1, select the output cycle you wish to output. <b>1Hz: 1 data output per second</b> 5Hz: 5 data outputs per second 10Hz: 10 times data output per second *GSA and GSV will output data at 1Hz (once per second) even when 1, 5, or 10Hz is selected.
GGA Use	Select "ON" to output NMEA messages, and "OFF" not to output them. <b>*Normally "ON"</b> <b>GGA output is required to use location information.</b>
GNS Use	Same as above(number of acquired satellites etc.)
GSA Use	Same as above (such as satellite number)
GSV Use	Same as above (Satellite elevation angle, azimuth angle, signal strength, etc.)
RMC Use	Same as above( <b>Location information, etc.: Not used by SmartMate</b> )
VTG Use	Same as above (Moving direction, speed, etc.)
ZDA Use	Same as above (SmartMate uses the date)
GST Use	Same as above ( <b>Used to display RMS when measuring with SmartMate</b> )

## 10-2-2. "SC Rover" rover settings

Item	Setting Values and Descriptions
Base station distance	When set to "ON", SmartMate can display the distance to the base station.
Elevation Mask	Elevation angle mask setting. Select from 5, 10, 15, and 20 degrees. Normally, "15 degrees" is selected.
SN Mask	Satellites whose signal strength is less than the set signal strength (SN ratio) of satellites received by the mobile station are not used for analysis. If positioning is difficult for the mobile station, setting a low SN Mask increases the probability of RTK-FIX, but lowers the positioning accuracy guarantee. *Normally, the default setting of "6" should be fine in places with good positioning conditions. *Example) The default for other manufacturers is usually "30".
GPS	Satellite use cannot be turned ON or OFF. *The satellite will always be used.
GLONASS	"ON" when using satellites, Select OFF if not used.
Beidou	Same as above
Galileo	Same as above

Item	Setting Values and Descriptions
NTRIP Host	Enter the IP or domain of the NTRIP connection destination.
NTRIP Port	Enter the destination port. *Normally 2101
NTRIP MountPoint	Enter the mount point to connect to.
NTRIP id	Enter the ID of the connection destination issue.
NTRIP Password	Enter the password for the connection destination issue.



If "NTRIP" is selected under 【RTCM In Port】 , make the setting.  
Enter when setting the Ntrip connection destination on the receiver itself.  
**It is not used in "SC Rover" + "Smart Mate".**

※ **Example of use:**  
"SC Rover" is used when capturing NMEA data of RTK-GNSS using Ntrip with an external application.  
\*An Android device or Wi-Fi router that can communicate with the Internet is required.

# 10-2-3. Rover Setup

10-2-3-1. Using "SmartMate" with "Ntrip" method at rover

# 10-2-3-1. Using "SmartMate" with "Ntrip" method at rover

## Normal Use of SC Rover and SmartMate

Using "SC Rover" as a mobile station with networked RTK-GNSS (freely selectable connection destination)  
 Using "SmartMate" application for measurement, localization, etc.

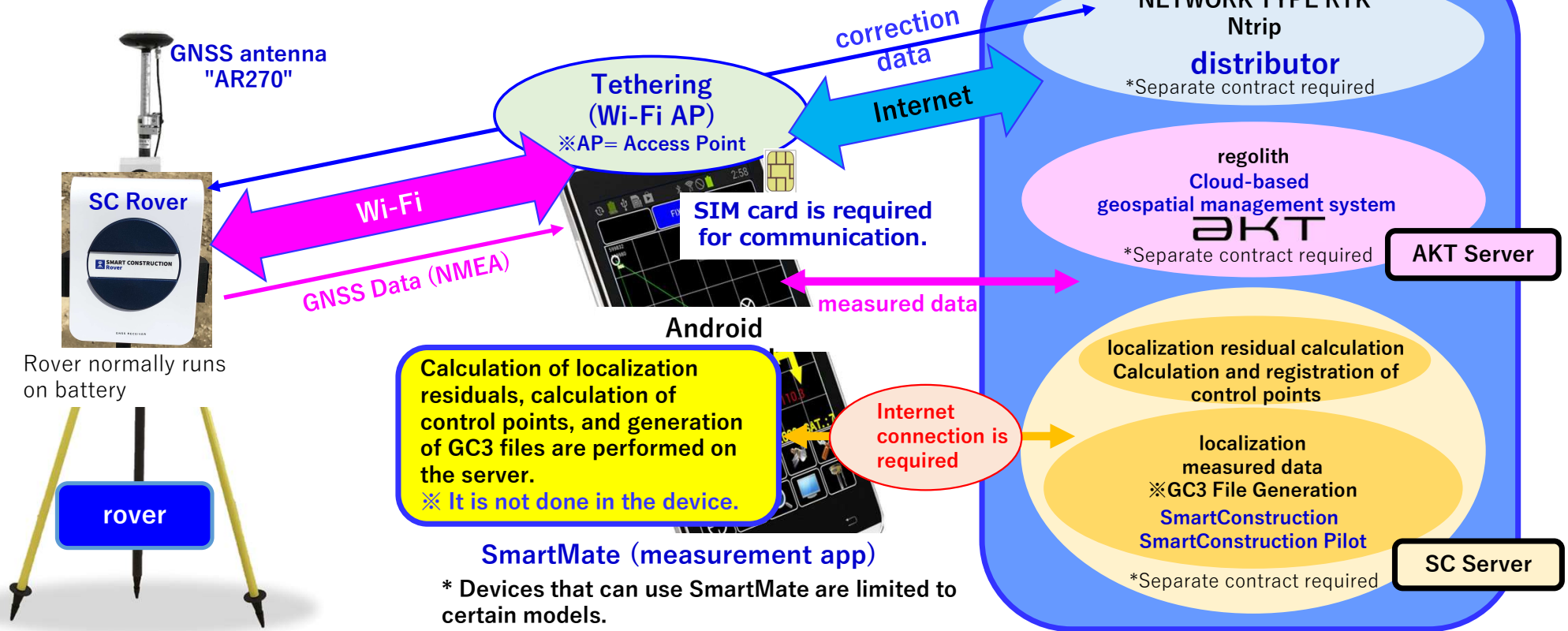

## 10-2-3-1. Using "SmartMate" with "Ntrip" method at rover

After connecting to Receiver See Chapter 9

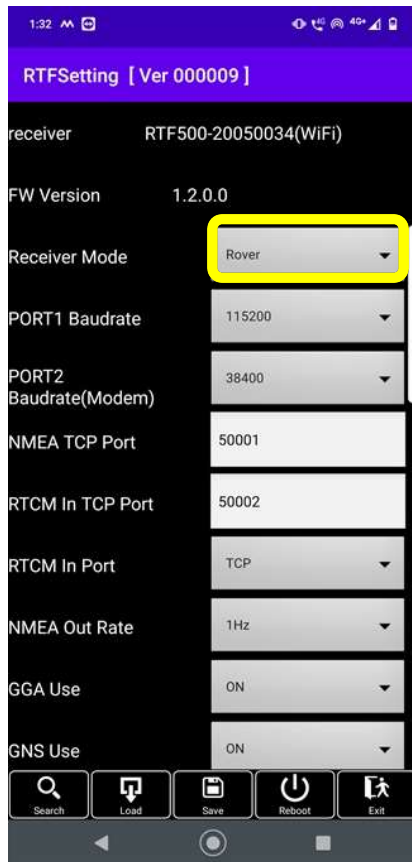

**"Receiver Mode"**  
Tap.

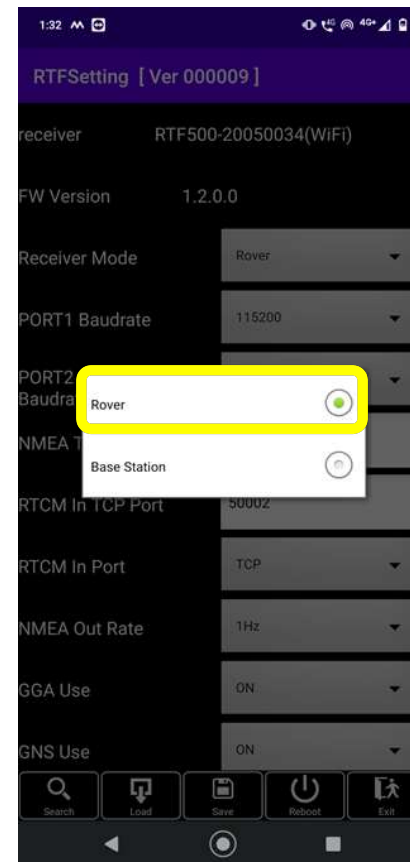

**"Rover"**  
Tap.

## 10-2-3-1. Using "SmartMate" with "Ntrip" method at rover

### Using "SmartMate" with "Ntrip" method at rover.

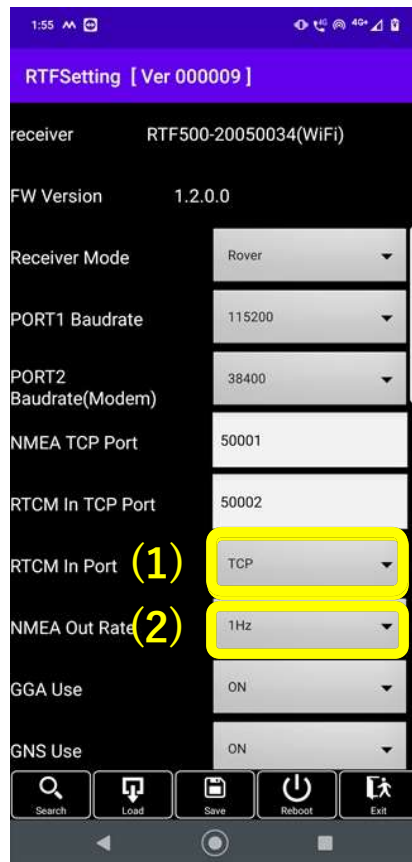

**Important**  
(1) Set "RTCM In Port" to "TCP".

\* If you select "Port2" etc., you cannot perform Ntrip with SmartMate.

(2) Specify the NMEA output interval in "NMEA Out Rate".  
When using SmartMate, set it to "1Hz".

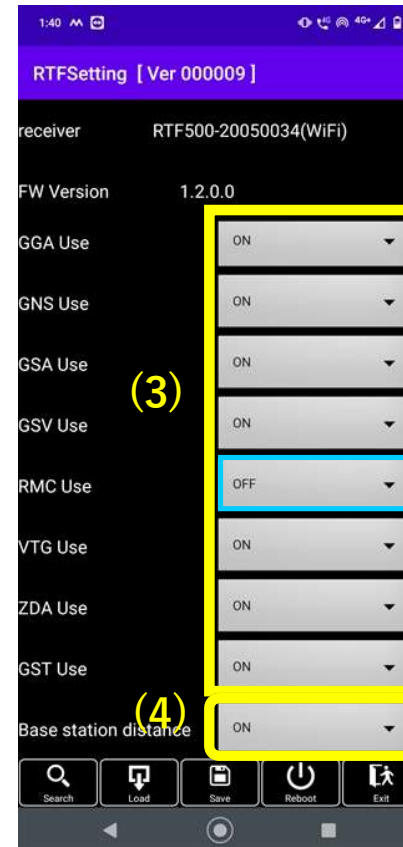

(3) Select the NMEA message you want to output.  
Set the message you want to output to "ON".

\* When using Rover app, set "ON" except for "RMC".

(4) Set "Base station distance" to "ON".  
\* When set to "ON", the distance to the base station used during SmartMate measurement is displayed.



## 10-2-3-1. Using "SmartMate" with "Ntrip" method at rover

### Using "SmartMate" with "Ntrip" method at rover.

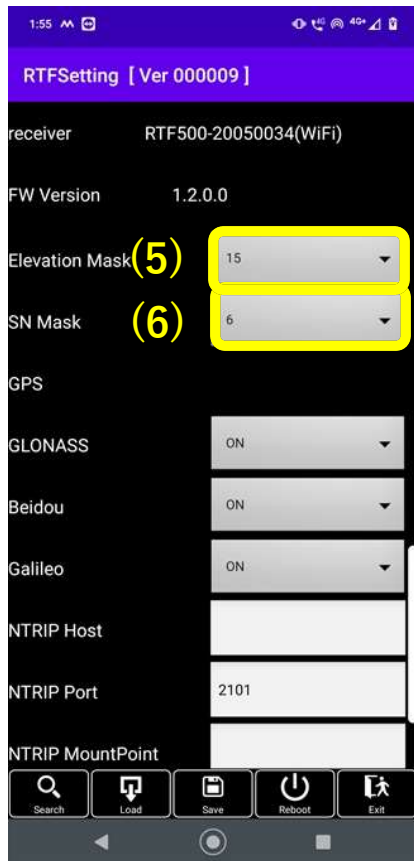

#### (5) "Elevation Mask"

Specifies the elevation angle of the satellite to use for analysis in the receiving satellite. Normally select "15".

#### (6) "SN Mask"

Satellites whose signal strength is less than the set signal strength (SN ratio) of satellites received by the mobile station are not used for analysis.

If positioning is difficult for the mobile station, set the SN Mask low.

The probability of getting RTK-FIX is high, but the guarantee of positioning accuracy may be low.

\* Normally, it is recommended to select "6" or "30" in places where the sky is open.

\*Example) The default for other manufacturers is usually "30".

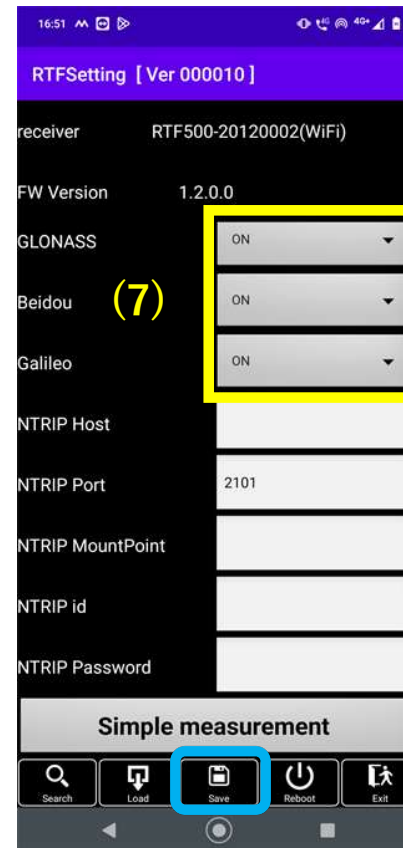

(7)  
Select the satellite constellation to be used for analysis by the mobile station. Set unused satellites to "OFF".  
\*GPS satellites cannot be turned off.

※ Normally everything is "ON" and there is no problem.

Check and Tap Save.

## 10-2-3-1. Using "SmartMate" with "Ntrip" method at rover

### Using "SmartMate" with "Ntrip" method at rover.

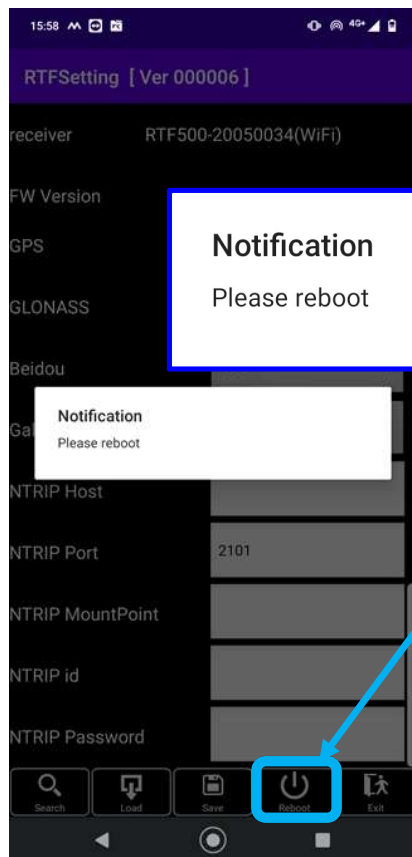

If the write succeeds, the above message will be displayed.

Tap Reboot.

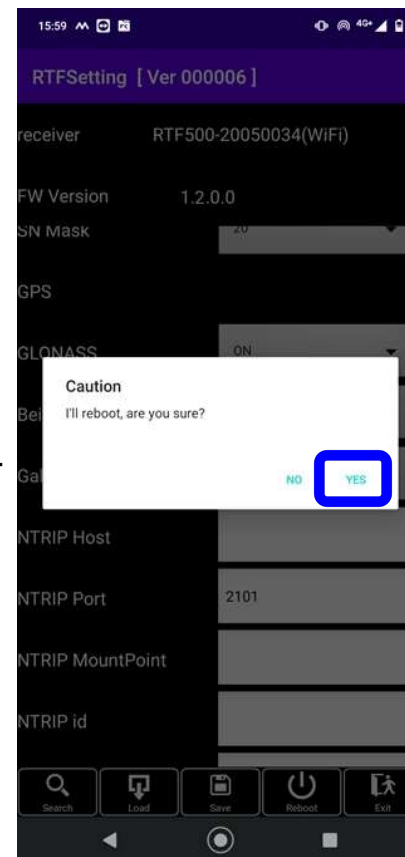

After tapping Reboot, tap YES.

Receiver power will be turned off.

## 10-2-3-1. Using "SmartMate" with "Ntrip" method at rover

### Using "SmartMate" with "Ntrip" method at rover.

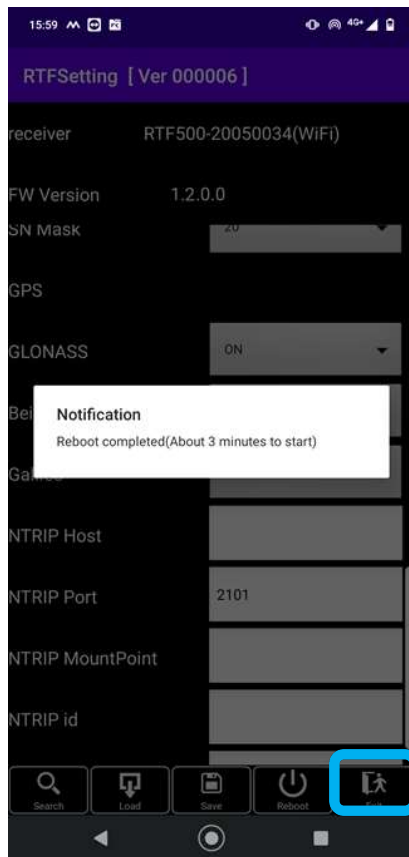

Tap "Exit" to exit the app.

"Reboot" will turn off the power of the receiver.

- **When using batteries,**  
**press the power button to turn on** and set it to "ON" to reflect the settings.
- **If external power is supplied, the power will automatically turn on and the settings will be reflected.**

**After that, even if the power of the GNSS receiver is turned off, it will start up with the same settings until the settings are changed.**

## 10-2-3-1. Using "SmartMate" with "Ntrip" method at rover

### Using "SmartMate" with "Ntrip" method at rover.

#### SmartMate Application



The connection settings of the mobile station to "Ntrip" are configured in the "SmartMate" settings.

Menu:  
Select "VRS Settings".

#### SmartMate - VRS Settings Screen

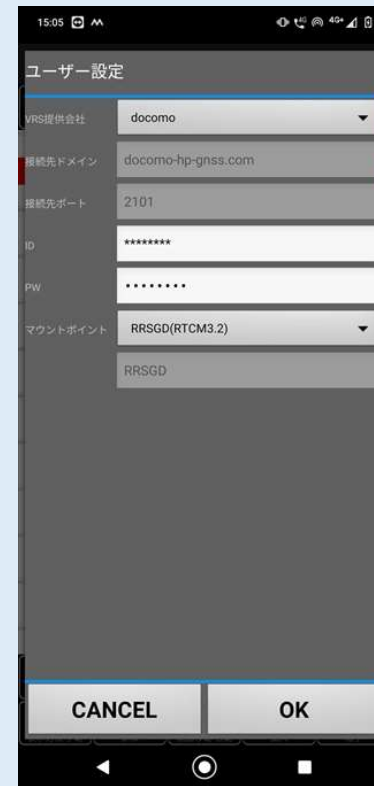

Select the connection destination, enter the ID and PW issued by the contracted distribution company, and select the mount point.

\*For details, refer to the "SmartMate Manual".

# 10-2-3. Rover Setup

10-2-3-2. Using an "external radio" with the rover

## 10-2-3-2. Using an "external radio" with the rover

### Using an "external radio" with the rover

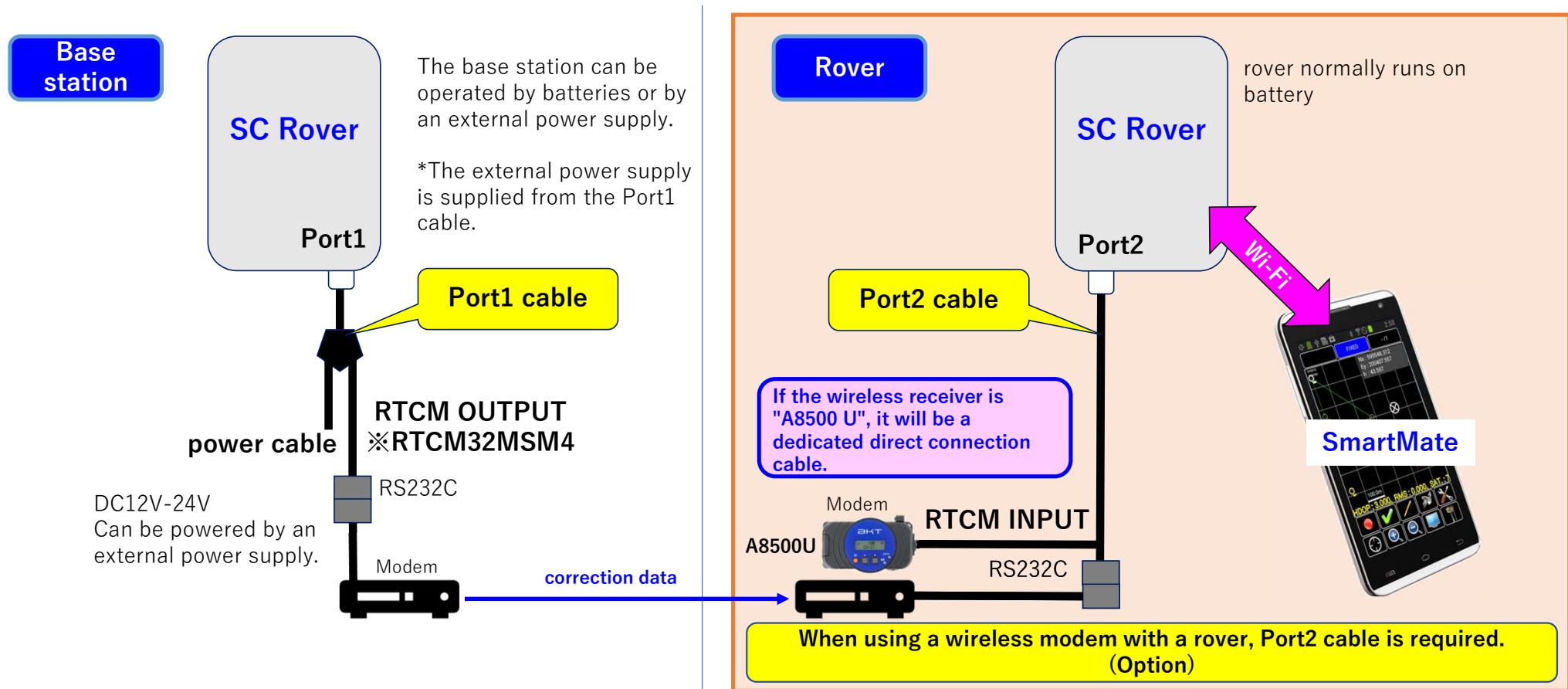

## 10-2-3-2. Using an "external radio" with the rover

After connecting to Receiver

See Chapter 9

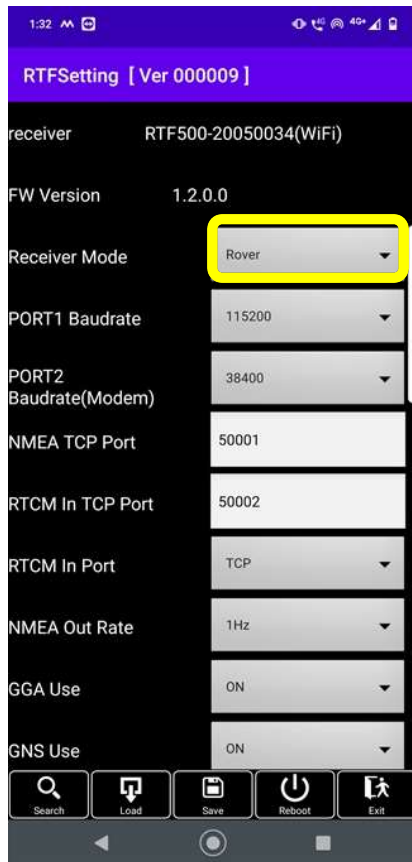

"Receiver Mode"  
Tap.

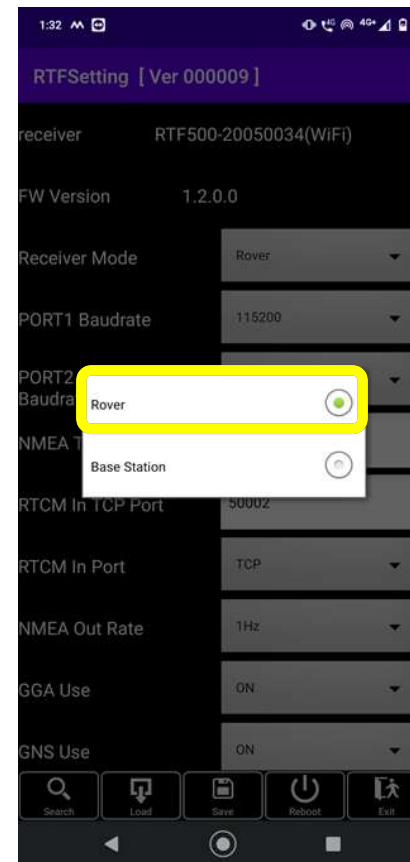

"Rover"  
Tap.

## 10-2-3-2. Using an "external radio" with the rover

### Using an "external radio" with the rover

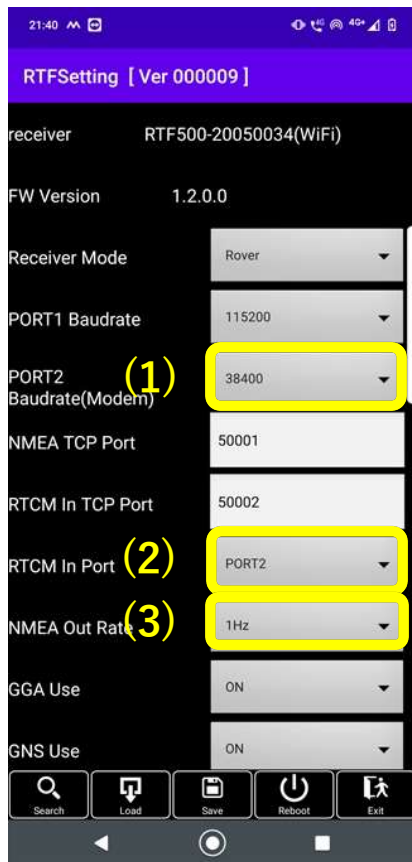

- (1) Select the baud rate (communication speed) of the radio used in "PORT2 Boudrate (Modem)".
- (2) Select "PORT2" if you want to use an external radio with "RTCM InPort".
- (3) Specify the NMEA output interval in "NMEA Out Rate".  
When using Rover app, set it to "1Hz".



- (4) Select the NMEA message you want to output.  
Set the message you want to output to "ON".  
\* When using Rover app, set "ON" except for "RMC".
- (5) Set "Base station distance" to "ON".  
\* When set to "ON", the distance to the base station used during SmartMate measurement is displayed.



## 10-2-3-2. Using an "external radio" with the rover

### Using an "external radio" with the rover

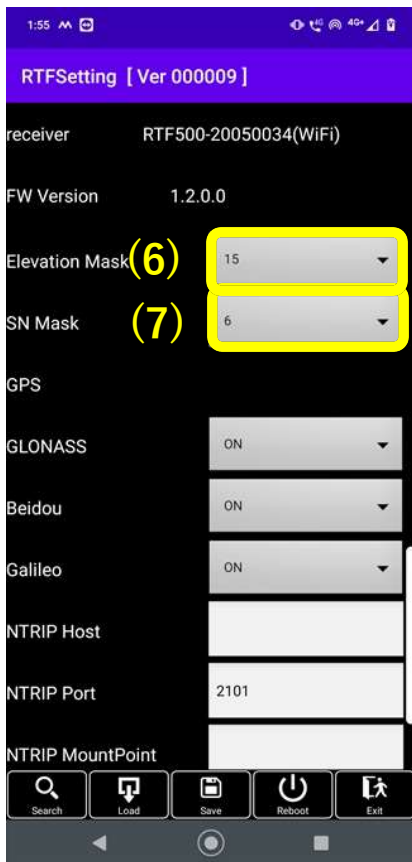

(6)  
**"Elevation Mask"**  
Specifies the elevation angle of the satellite to use for analysis in the receiving satellite.  
Normally select "15".

(7)  
**"SN Mask"**  
Satellites whose signal strength is less than the set signal strength (SN ratio) of satellites received by the mobile station are not used for analysis.  
If positioning is difficult for the mobile station, set the SN Mask low.  
The probability of getting RTK-FIX is high, but the guarantee of positioning accuracy may be low.  
\* Normally, it is recommended to select "6" or "30" in places where the sky is open.  
\*Example) The default for other manufacturers is usually "30".

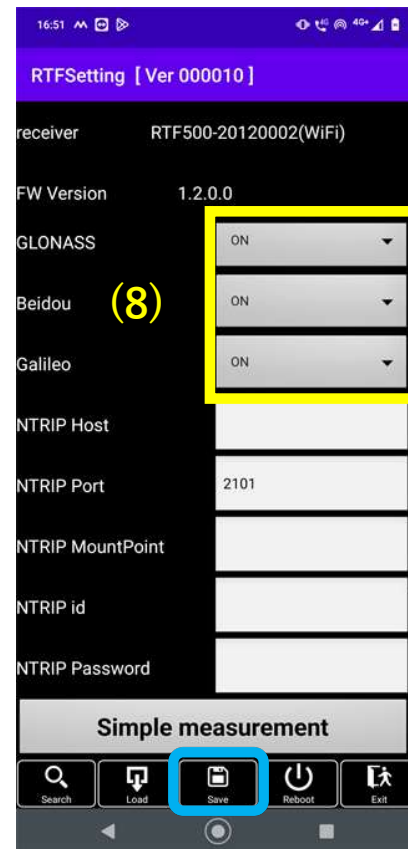

(8)  
Select the satellite constellation to be used for analysis by the mobile station.  
Set unused satellites to "OFF".  
\*GPS satellites cannot be turned off.

Check and  
**Tap Save.**

## 10-2-3-2. Using an "external radio" with the rover

### Using an "external radio" with the rover

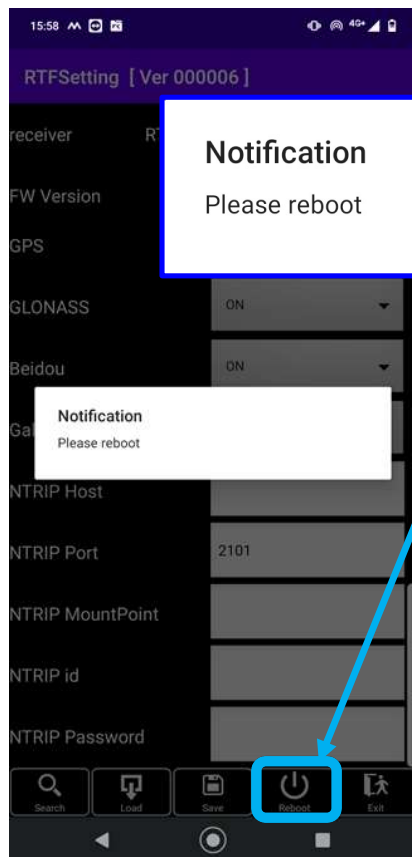

If the write succeeds,  
the above message will be displayed.

Tap Reboot.

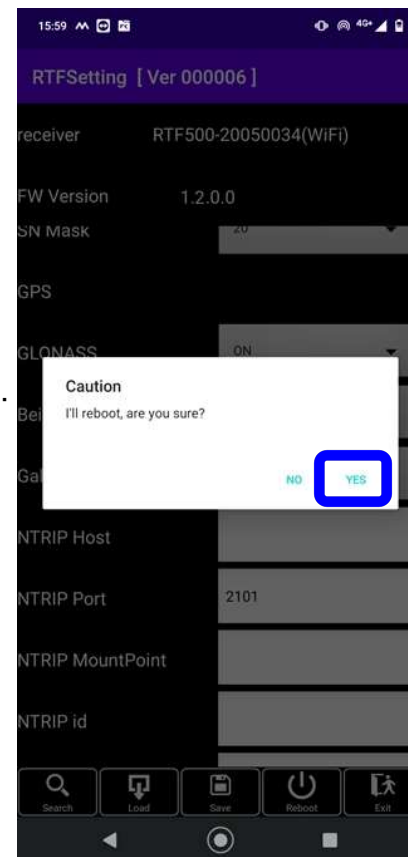

After tapping "Reboot",  
tap "YES".

Receiver power  
will be turned off.

## 10-2-3-2. Using an "external radio" with the rover

### Using an "external radio" with the rover

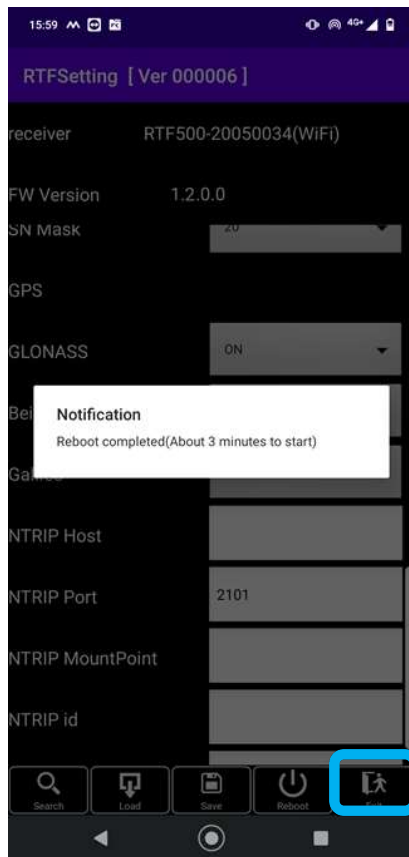

Tap "Exit" to exit the app.

"Reboot" will turn off the power of the receiver.

- **When using batteries,**  
**press the power button to turn on** and set it to "ON" to reflect the settings.
- **If external power is supplied, the power will automatically turn on and the settings will be reflected.**

**After that, even if the power of the GNSS receiver is turned off, it will start up with the same settings until the settings are changed.**

# 10-2-3. Rover Setup

10-2-3-3. Using the “Komatsu Ntrip Caster” with the rover

# 10-2-3-3. Using the “Komatsu Ntrip Caster” with the rover

## Using the “Komatsu Ntrip Caster” with the rover

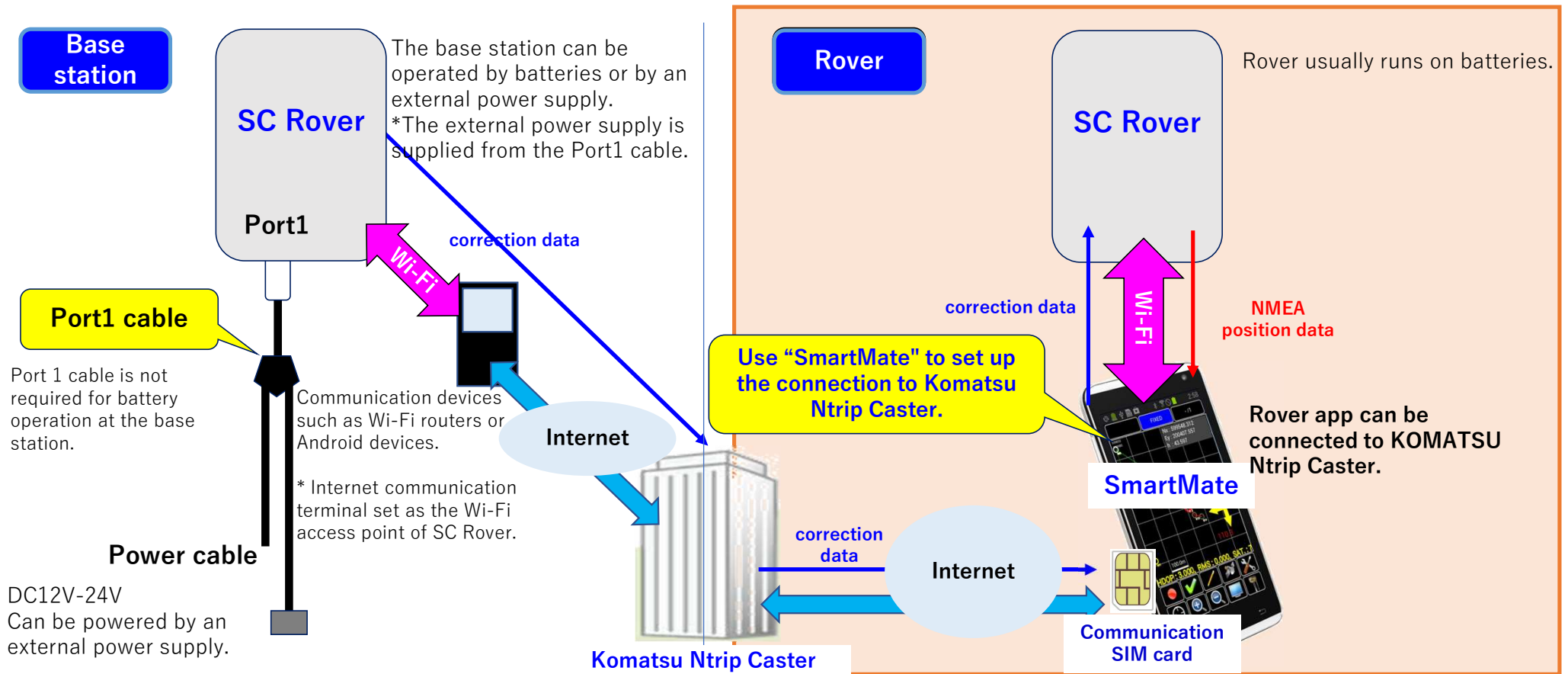

## 10-2-3-3. Using the “Komatsu Ntrip Caster” with the rover

After connecting to Receiver

[See Chapter 9](#)

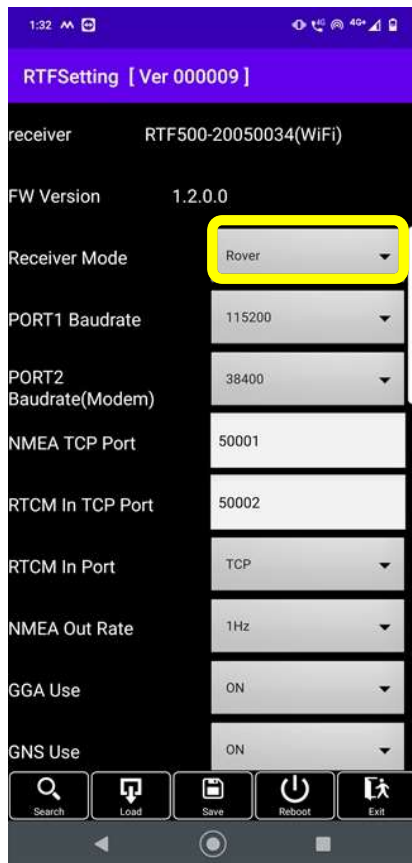

"Receiver Mode"  
Tap.

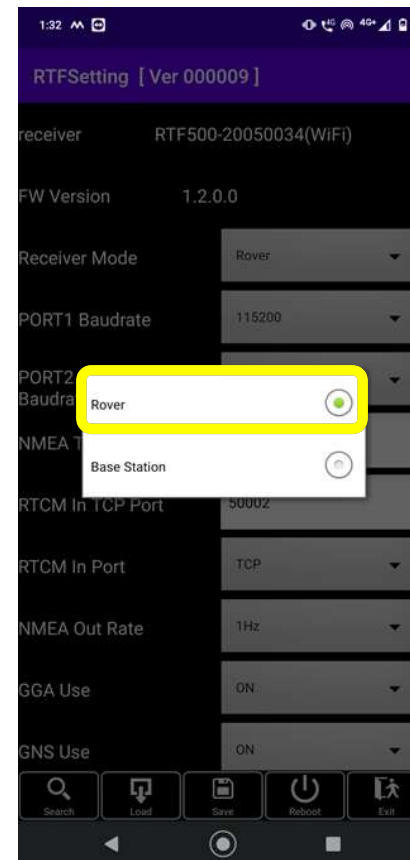

"Rover"  
Tap.

## 10-2-3-3. Using the “Komatsu Ntrip Caster” with the rover

Using the “Komatsu Ntrip Caster” with the rover \*Same setting as [Using "Ntrip" and "SmartMate" with rover].

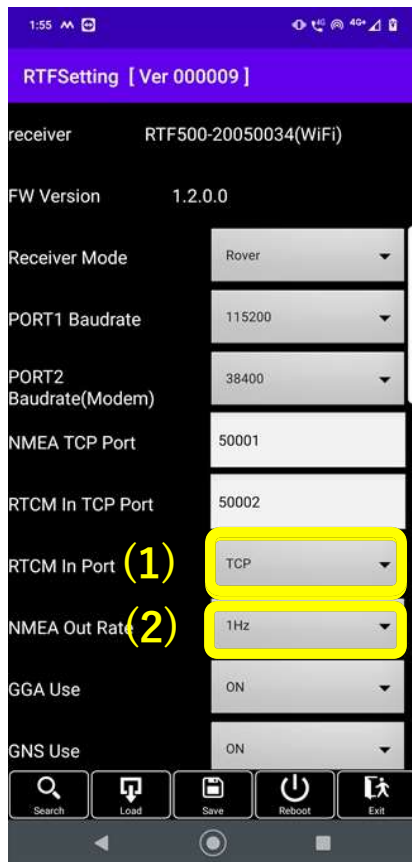

### Important

(1) Set "TCP" in "RTCM In Port" .

\* If you select "Port2" etc., you cannot perform Ntrip with Rover app.

(2) Specify the NMEA output interval in "NMEA Out Rate". When using Rover app, set it to "1Hz".

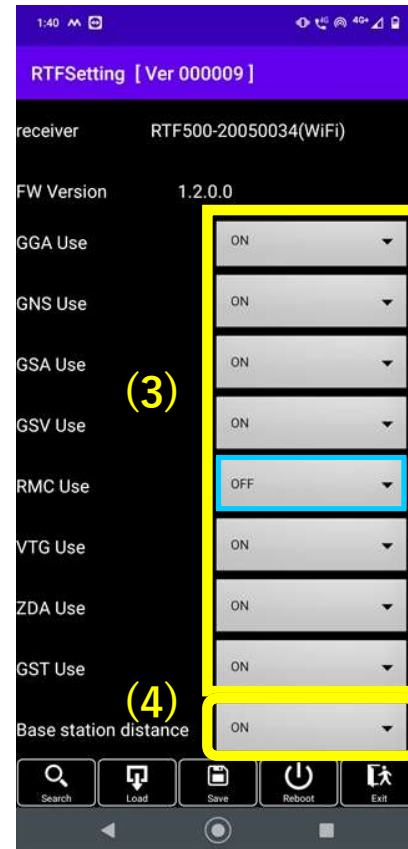

(3) Select the NMEA message you want to output. Set the message you want to output to "ON".

\* When using Rover app, set "ON" except for "RMC".

(4) Turn on the "Base station distance"

\* When set to "ON", the distance to the base station used during SmartMate measurement is displayed.

## 10-2-3-3. Using the “Komatsu Ntrip Caster” with the rover

Using the “Komatsu Ntrip Caster” with the rover \*Same setting as [Using "Ntrip" and "SmartMate" with rover].

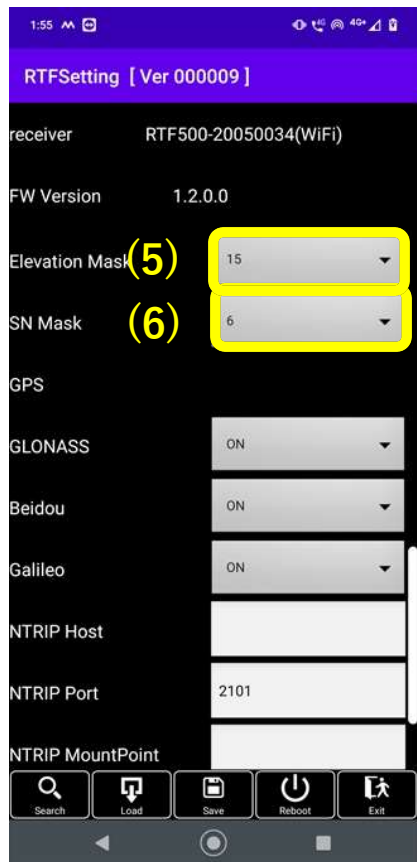

(5)  
**"Elevation Mask"**  
Specifies the elevation angle of the satellite to use for analysis in the receiving satellite. Normally select "15".

(6)  
**"SN Mask"**  
Satellites whose signal strength is less than the set signal strength (SN ratio) of satellites received by the mobile station are not used for analysis. If positioning is difficult for the mobile station, set the SN Mask low. The probability of getting RTK-FIX is high, but the guarantee of positioning accuracy may be low. \* Normally, it is recommended to select "6" or "30" in places where the sky is open. \*Example) The default for other manufacturers is usually "30".

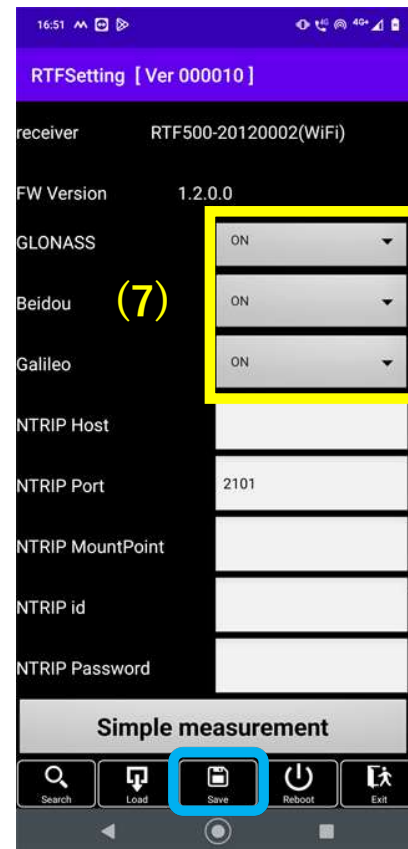

(7)  
Select the satellite constellation to be used for analysis by the mobile station. Set unused satellites to "OFF". \*GPS satellites cannot be turned off.

Check and Tap Save.



## 10-2-3-3. Using the “Komatsu Ntrip Caster” with the rover

Using the “Komatsu Ntrip Caster” with the rover \*Same setting as [Using "Ntrip" and "SmartMate" with rover].

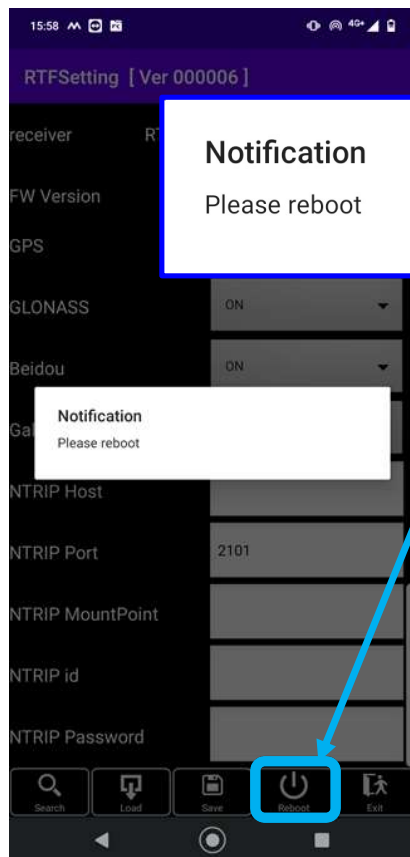

If the write succeeds,  
the above message will be displayed.

Tap “Reboot”.

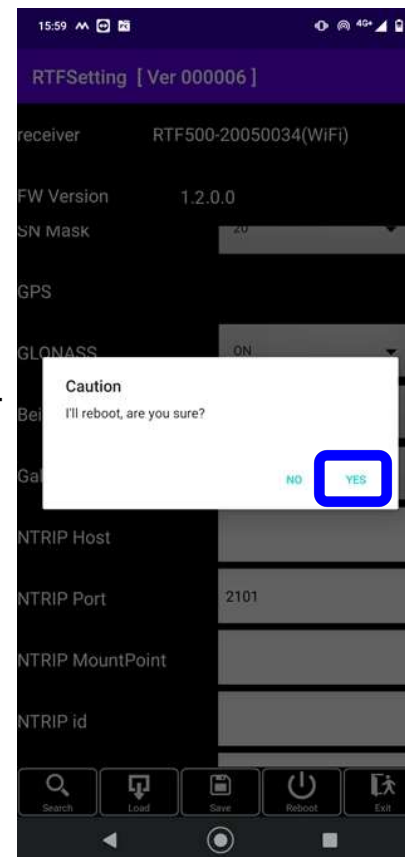

After tapping “Reboot”,  
tap “YES”.

Receiver power  
will be turned off.

## 10-2-3-3. Using the “Komatsu Ntrip Caster” with the rover

Using the “Komatsu Ntrip Caster” with the rover \*Same setting as [Using "Ntrip" and "SmartMate" with rover].

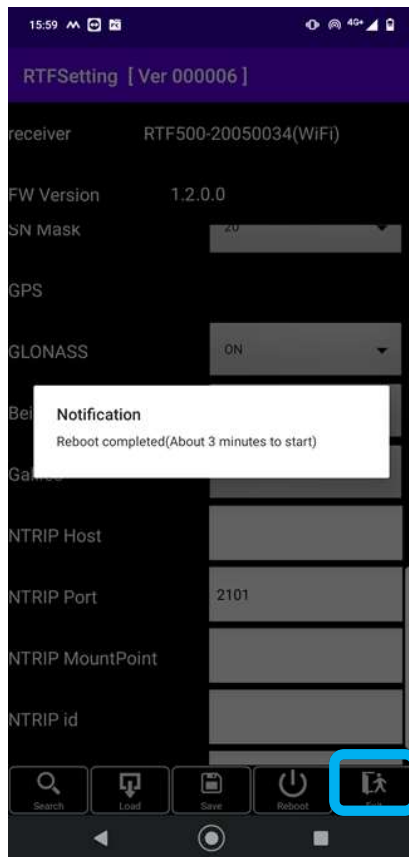

Tap "Exit" to exit the app.

"Reboot" turns off the receiver's power supply

- **When using batteries,**  
**Press the power button to turn on** and start to reflect the settings.
- **When external power is supplied, the power** is automatically turned on and the setting is reflected.

**From then on, until you change the settings,**  
**Turn off the GNSS receiver and start with the same settings.**

## 10-2-3-3. Using the “Komatsu Ntrip Caster” with the rover

### Using the “Komatsu Ntrip Caster” with the rover

#### SmartMate Application

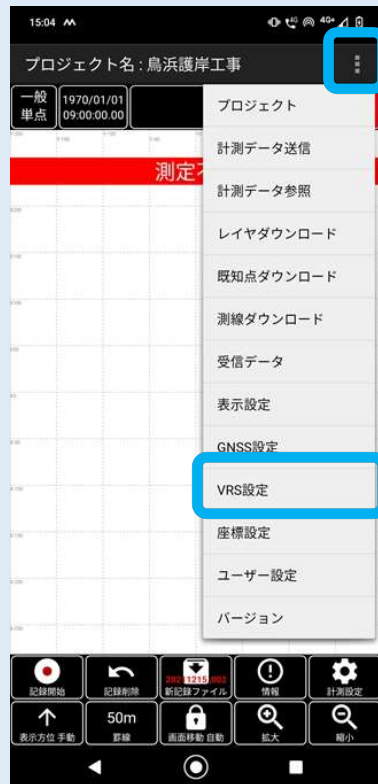

The connection settings of the mobile station to "Ntrip" are configured in the "SmartMate" settings.

Menu:  
Select "VRS Settings".

#### SmartMate - VRS Settings Screen

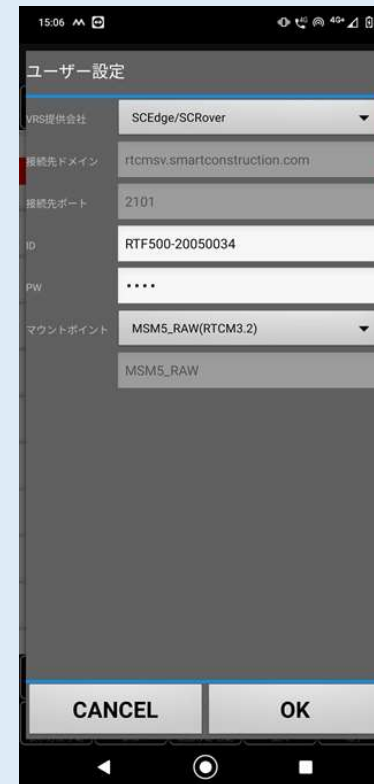

VRS Provider:  
Select “SCEdge/SC Rover”..

ID: Enter the serial number of the SC Rover used at the base station.

\*When inputting, be sure to add "RTF500-" to the header.

**Input example : RTF500-20050034**

PW: Please check with each person

Mount point:  
The recommendation is  
"MSM5\_RAW(RTCM3.2)"  
or "MSM4\_RAW(RTCM3.2)"

\*For more information, see  
“SmartMate Manual”.

# Chapter 11

## Simple Measurement of base station Coordinates

## 11-1. About simple measurement of base station coordinates

### ■ About simple measurement of base station coordinates

It is used when there is no coordinate value of the location where the GNSS base station is installed at the site to be used.

Measure the coordinate values of the GNSS receiver of the base station to be used in rover mode, and set up the acquired coordinate values (latitude/longitude/elliptical height) as the base station coordinate values.

(1) If the coordinate values of the base station cannot be measured by Ntrip outside the communication area, the GNSS receiver used to obtain the coordinate values of the reference point (SGPS, a few meters error from the actual coordinates) was obtained. Set up the coordinate values (latitude/longitude/ellipsoidal height) as base station coordinate values.

(2) If you are within the communication area, use Ntrip (network RTK-GNSS) to set up with almost accurate public coordinate values (latitude / longitude / ellipsoid height) obtained with FIX values (actual coordinates and a few cm error). can be done.

(3) Install (fix) the base station, and then perform measurement.

\*If localization is performed using this installed (fixed) base station, it is not possible to change the height after installation.  
(must be permanently fixed)

## 11-2. Simple measurement setup of base station coordinates

### Example) SC Rover(RTF500)



Connect to the receiver.

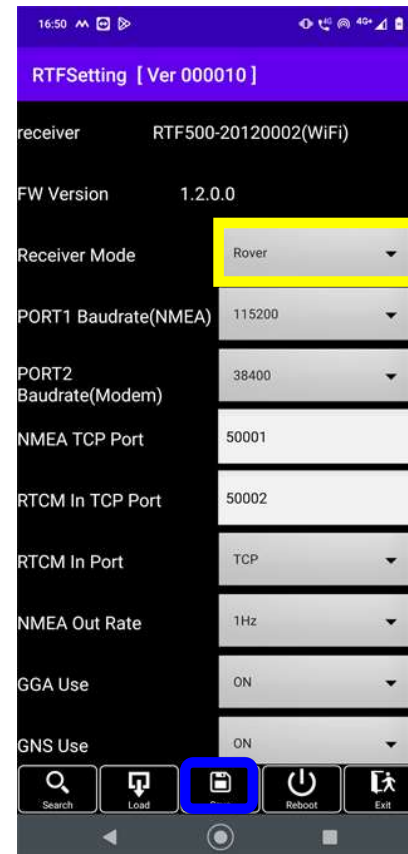

Setup in Rover mode

## 11-2. Simple measurement setup of base station coordinates

### Example) SC Rover(RTF500)

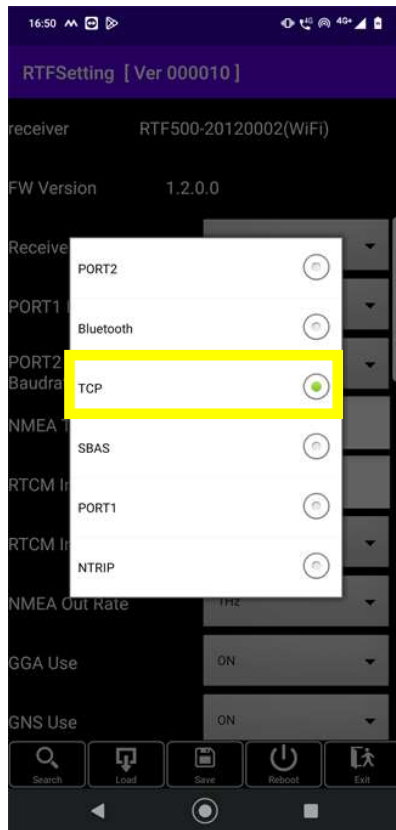

Be sure to select "TCP" when measuring the base station coordinates with Ntrip.

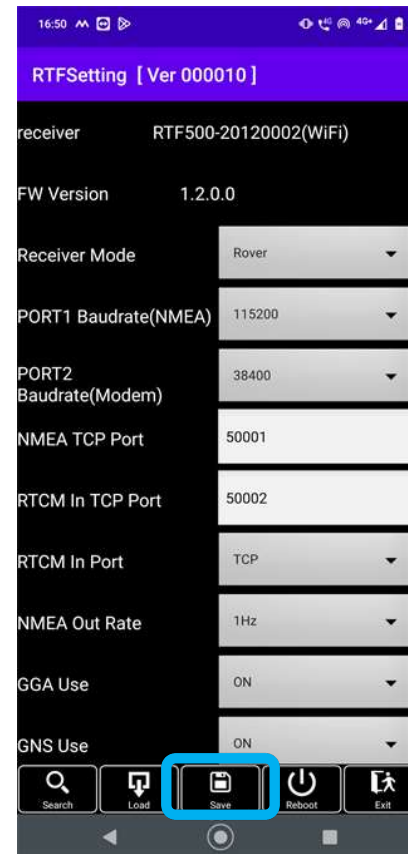

Check the settings such as the satellite to use, and tap "Save".

## 11-2. Simple measurement setup of base station coordinates

### Example) SC Rover(RTF500)

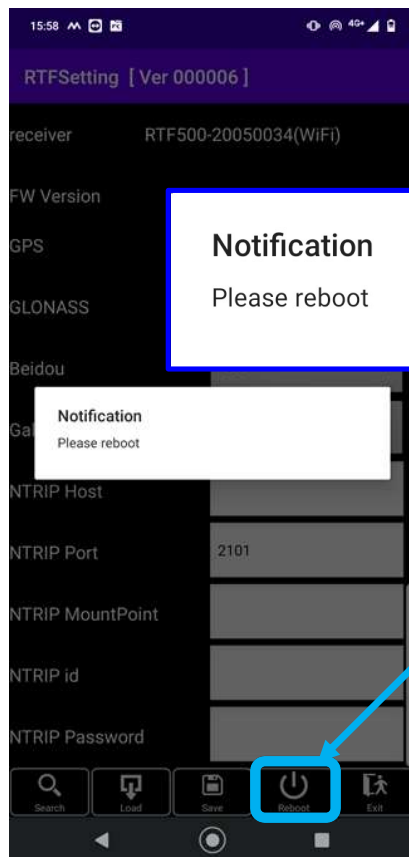

If the writing is successful, the above message will be displayed, so tap "Reboot".

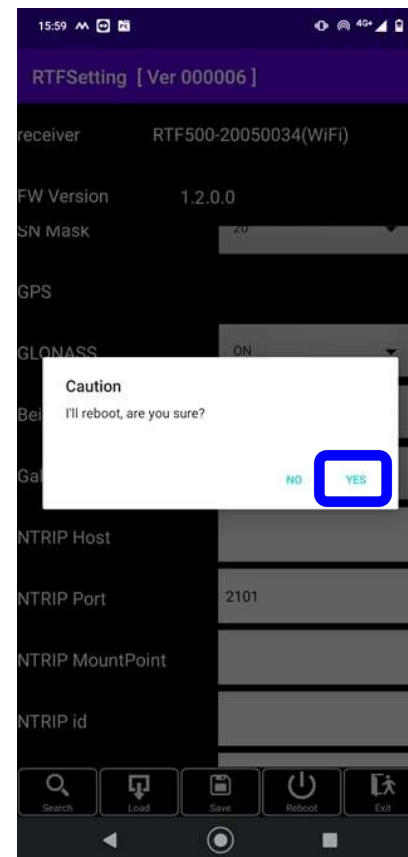

After tapping Reboot, tap YES.

The power of the receiver is turned off.



## 11-2. Simple measurement setup of base station coordinates

### Example) SC Rover(RTF500)

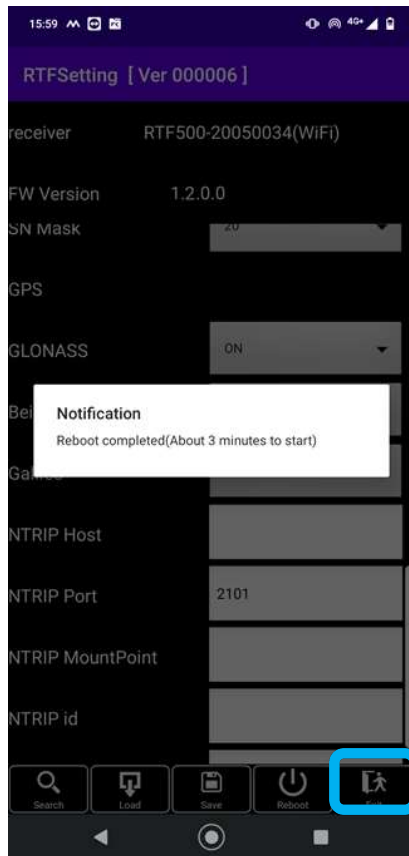

Tap "Exit" to exit the app.

"Reboot" will turn off the power of the receiver.

- When using batteries, press the power button and turn it on to reflect the settings.
- If external power is supplied, the power will automatically turn on and the settings will be reflected.

**After that, even if the power of the GNSS receiver is turned off, it will start up with the same settings until the settings are changed.**

## 11-2. Simple measurement setup of base station coordinates

### Example) SC Rover(RTF500)



Connect to the receiver.

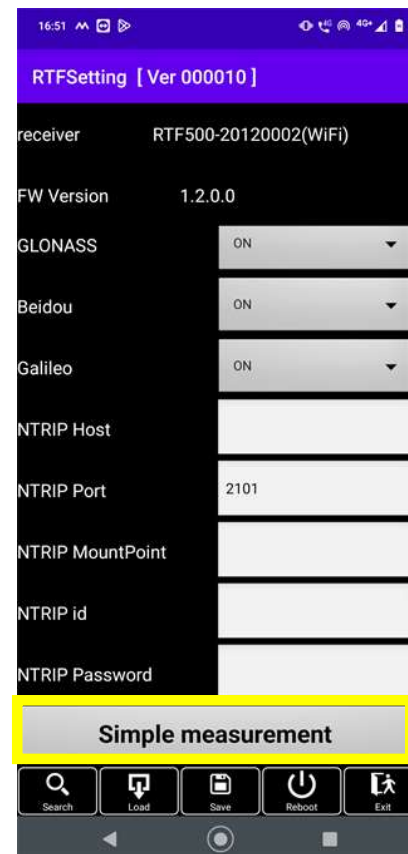

Tap Simple measurement.

## 11-2. Simple measurement setup of base station coordinates

### Example) SC Rover(RTF500)

Simple Measurement

Number of Meas: 1 ~ 600 10

Effective accuracy SGPS

Point Name T-1

NTRIP Host

NTRIP Port

NTRIP MountPoint

NTRIP id

NTRIP Password

Accuracy

Count

Lat

Lon

Ellipse

Start Save End

(1) When obtaining coordinates by SGPS (single positioning)

- **Number of Meas**  
Enter how many epochs of data to average.
- **Effective accuracy**  
Select SGPS.
- **Point Name**  
Enter the point name.

Tap Start.

Simple Measurement

Number of Meas: 1 ~ 600 10

Effective accuracy SGPS

Point Name T-1

NTRIP Host

NTRIP Port

NTRIP MountPoint

NTRIP id

NTRIP Password

Accuracy SGPS

Count 10

Lat 35.379494006

Lon 139.644389982

Ellipse 43.811

Start Save End

Shows the average value for the specified epoch.

To save, tap "Save".

## 11-2. Simple measurement setup of base station coordinates

### Example) SC Rover(RTF500)

Simple Measurement

Number of Meas: 1 ~ 600 10

Effective accuracy RTK Fix

Point Name T-2

NTRIP Host d-gnss.jp

NTRIP Port 2101

NTRIP MountPoint RRS GD

NTRIP id \*\*\*\*\*

NTRIP Password \*\*\*\*\*

Accuracy

Count

Lat

Lon

Ellipse

Start Save End

(2)  
When connecting to  
Ntrip to get coordinates

- **Number of Meas**  
Enter how many epochs of data to average.
- **Effective accuracy**  
Select RTK Fix.
- **Point Name**  
Enter the point name.
- **Enter the destination of the NTRIP.**

Tap Start.

Simple Measurement

Number of Meas: 1 ~ 600 10

Effective accuracy RTK Fix

Point Name T-2

NTRIP Host d-gnss.jp

NTRIP Port 2101

NTRIP MountPoint RRS GD

NTRIP id \*\*\*\*\*

NTRIP Password \*\*\*\*\*

Accuracy DGPS

Count 0

Lat

Lon

Ellipse

Start Save End

It may take some time to connect to Ntrip and get FIX..

## 11-2. Simple measurement setup of base station coordinates

### Example) SC Rover(RTF500)

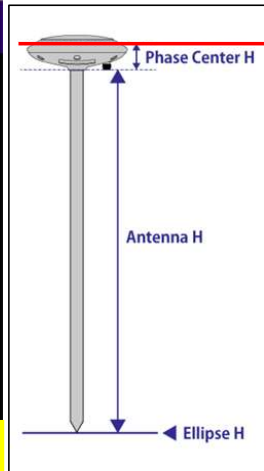
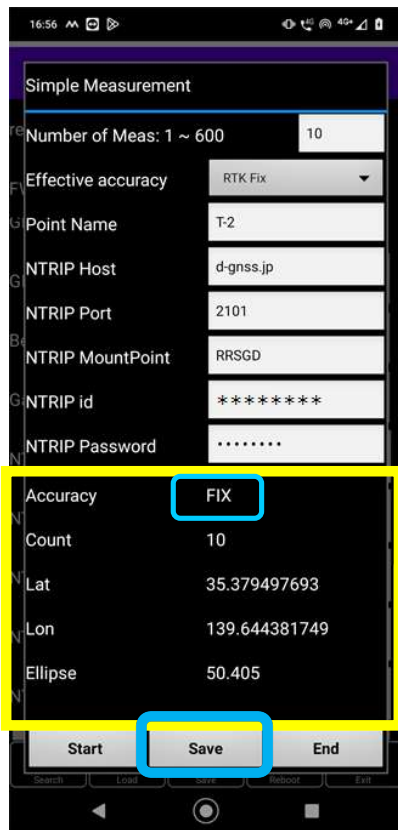

The ellipsoid height to be measured will be here.

When it becomes FIX, the average value of the specified epoch is displayed.

To save, tap "Save"

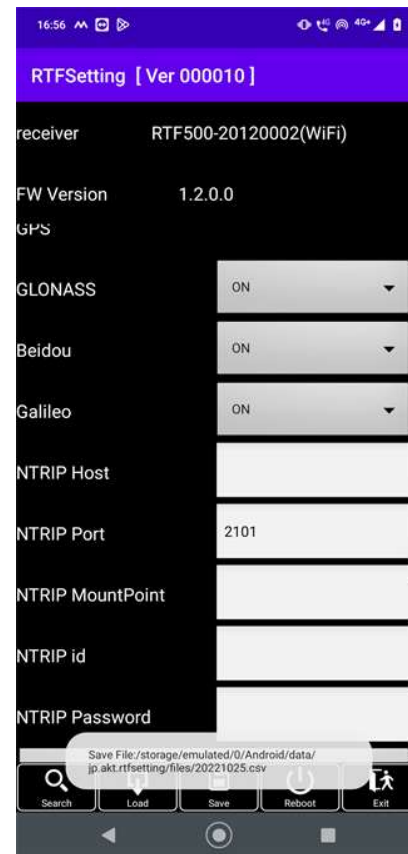

The file is saved in the specified folder.

\* The file name is saved with the date of measurement.  
"YYYYMMDD.csv"

If you measure twice or more on the same day, it will be added to the file and saved.

## 11-2. Simple measurement setup of base station coordinates

### Example) SC Rover(RTF500)

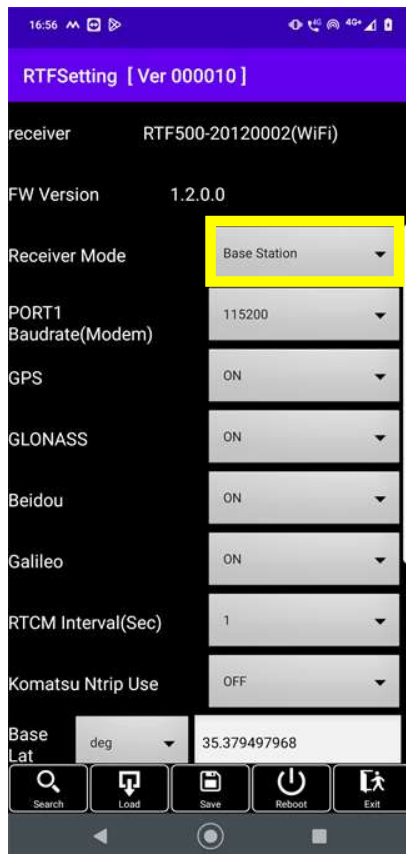

Set up the base station.

Change to Base Station.

Check other settings such as the GNSS constellation to use.

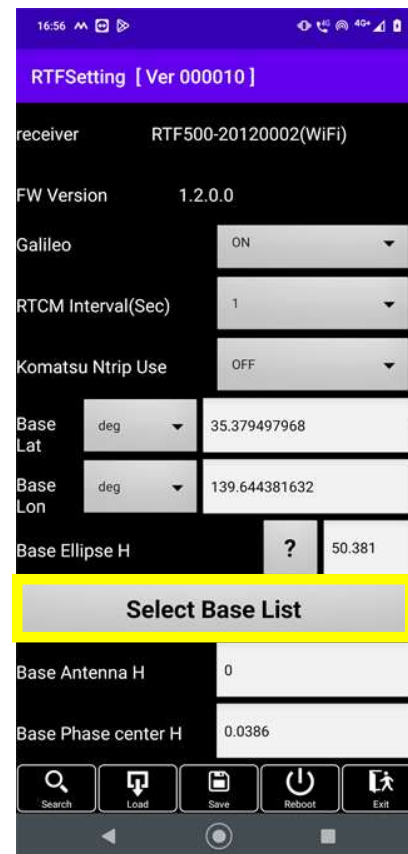

Tap Select Base List.

## 11-2. Simple measurement setup of base station coordinates

### Example) SC Rover(RTF500)

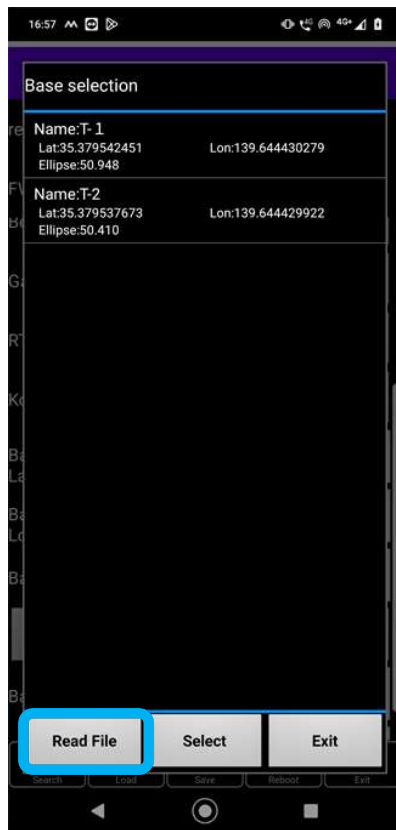

Tap "Read File".

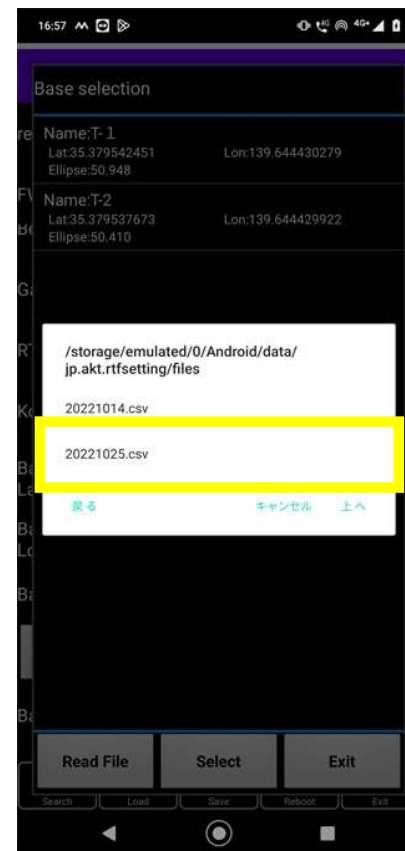

Tap the file with the date you measured.

## 11-2. Simple measurement setup of base station coordinates

### Example) SC Rover(RTF500)



Tap the measured coordinate value to use for setup.

Tap Select.

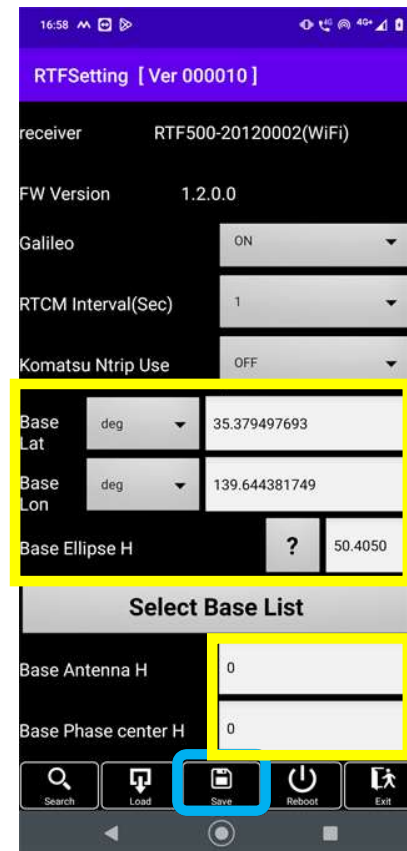

BaseLat, BaseLon, Base Ellipse H coordinates are reflected.

Enter "0" for Base Antenna H and Base Phase center H.

Tap Save.



## 11-2. Simple measurement setup of base station coordinates

### Example) SC Rover(RTF500)

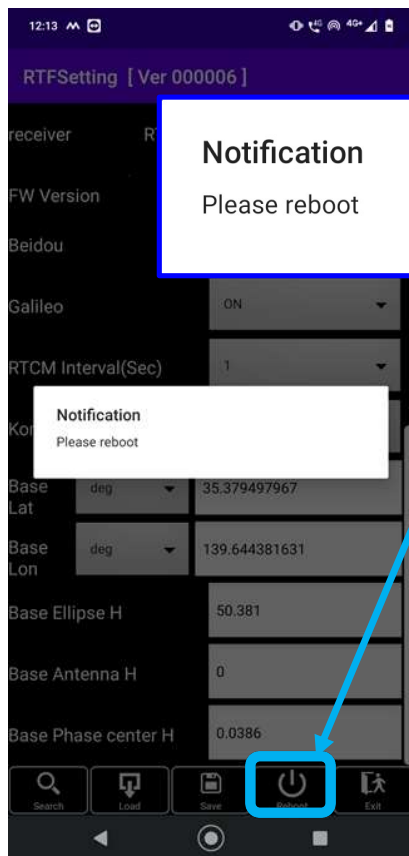

If the write succeeds,  
the above message will be displayed.

Tap Reboot.

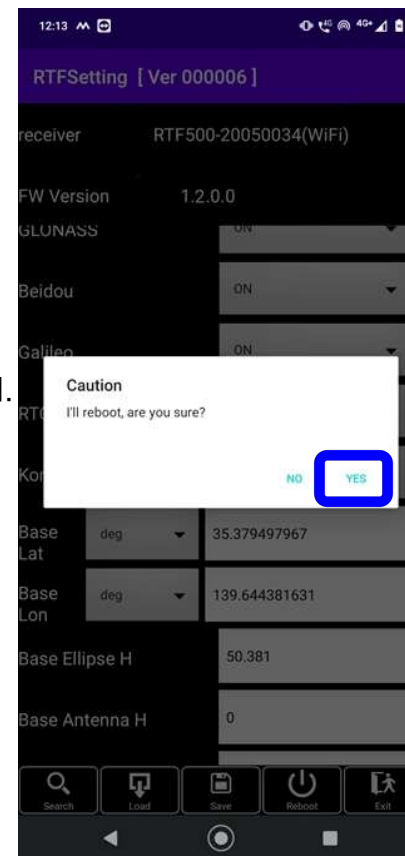

After tapping Reboot, tap YES.

Receiver power  
will be turned off.

## 11-2. Simple measurement setup of base station coordinates

### Example) SC Rover(RTF500)

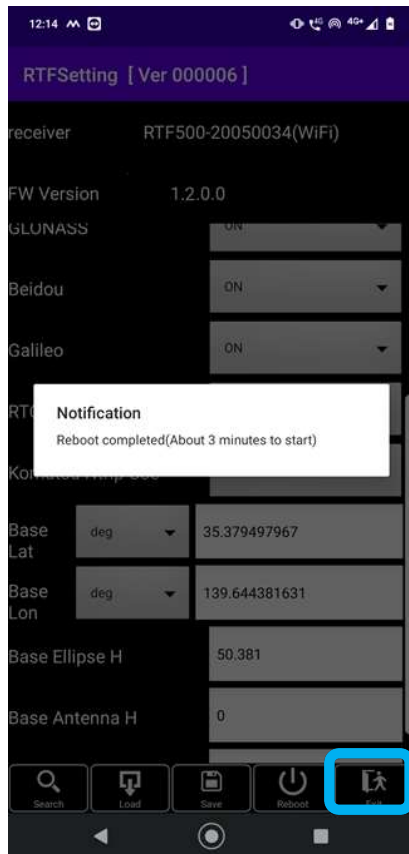

Tap "Exit" to exit the app.

"Reboot" will turn off the power of the receiver.

- When using batteries, press the power button and turn it on to reflect the settings.
- If external power is supplied, the power will automatically turn on and the settings will be reflected.

**After that, even if the power of the GNSS receiver is turned off, it will start up with the same settings until the settings are changed.**

# Contact information

EARTH BRAIN

Support site inquiry:

<https://support.smartconstruction.com/hc/ja/requests/new>